



Installation and Operation Manual

Blackmagic Pocket Cinema Camera

Includes Blackmagic Pocket Cinema Camera 6K
and Blackmagic Pocket Cinema Camera 4K

July 2019



Welcome

Thank you for purchasing your new Blackmagic Pocket Cinema Camera!

In 2013, we released the original Blackmagic Pocket Cinema Camera. We were excited by creating a small camera with high dynamic range and groundbreaking image quality that you could take anywhere. After all your amazing feedback and being asked to make a 4K version, we decided to do exactly that and introduced Blackmagic Pocket Cinema Camera 4K in 2018. Now we are happy to introduce Blackmagic Pocket Cinema Camera 6K!

Blackmagic Pocket Cinema Camera 6K features a Super 35mm sized sensor and an EF lens mount. Blackmagic Pocket Cinema Camera 4K has the same Micro Four Thirds lens mount as the original Pocket Cinema Camera so you can use all your existing MFT lenses. Blackmagic Pocket Cinema Camera 4K records 4K video up to 60 frames per second and HD video at 120 frames per second on CFast or UHS-II SD cards. Blackmagic Pocket Cinema Camera 6K expands on these capabilities so you can also record 2.8K video at 120 frames per second and 6K video up to 60 frames per second! The USB-C port lets you record on external drives so you can unplug the drive from your camera and plug straight into your computer for an instant file workflow.

With 13 stops of dynamic range and dual native ISO, you can record beautiful, clean cinematic images in varying light conditions. The built in 5 inch LCD touchscreen lets you easily check focus and see fine details, even in bright daylight, and four built in microphones give you high quality audio straight into the camera!

Your Blackmagic Pocket Cinema Camera is made from a carbon fiber reinforced composite so it's incredibly robust, very light, and easy to carry with you everywhere you go. Your camera can be powered via a standard LP-E6 battery, AC adaptor, or an external 12V DC source. We're also proud to include our Blackmagic RAW codec, offering the flexibility of RAW processing all in a single file, providing massive performance increases with reduced file sizes.

We are extremely excited to see the creative work you produce using your new Blackmagic Pocket Cinema Camera, and look forward to your feedback on new features you would like to see added to your camera!

A handwritten signature of Grant Petty in black ink. The signature is written in a cursive, flowing style.

Grant Petty

CEO Blackmagic Design

Contents

Blackmagic Pocket Cinema Camera

| | | | |
|---|----|---|-----|
| Which camera are you using? | 4 | Importing your Clips | 86 |
| Getting Started | 5 | Saving Your Project | 86 |
| Attaching a Lens | 5 | Working with Blackmagic RAW Files | 87 |
| Turning Your Camera On | 6 | Editing your Clips | 90 |
| Storage Media | 7 | Trimming Clips | 92 |
| CFast Cards | 7 | Adding Transitions | 92 |
| SD Cards | 9 | Adding Titles | 93 |
| USB-C flash disks | 11 | Color Correcting your Clips | 94 |
| Preparing Media for Recording | 13 | Using Scopes | 95 |
| Preparing Media on Blackmagic Pocket Cinema Camera | 13 | Secondary Color Correction | 97 |
| Preparing Media on a Mac | 15 | Qualifying a Color | 97 |
| Preparing Media on Windows | 16 | Adding a Power Window | 98 |
| Recording | 17 | Tracking a Window | 99 |
| Recording Clips | 17 | Using Plugins | 99 |
| Blackmagic RAW | 18 | Mixing Your Audio | 100 |
| Recording to Blackmagic RAW | 18 | Adding VFX and Compositing | 105 |
| Record Duration | 22 | The Fusion Page | 105 |
| Playback | 26 | Getting Started with Fusion | 107 |
| Camera Features | 27 | Using the Motion Tracker and Adding Text | 110 |
| Camera Front | 27 | Mastering your Edit | 113 |
| Right Side | 28 | Working with Third Party Software | 115 |
| Left Side | 28 | Working with Files from CFast 2.0 and SD cards | 115 |
| Camera Underside | 31 | Working with Files from USB-C flash disks | 115 |
| Camera Rear | 31 | Using Final Cut Pro X | 116 |
| Touchscreen Controls | 32 | Using Avid Media Composer 2018 | 116 |
| Settings | 51 | Using Adobe Premiere Pro CC | 117 |
| Dashboard | 51 | Blackmagic Camera Setup Utility | 118 |
| Record Settings | 52 | Developer Information | 119 |
| File Naming Convention | 57 | Blackmagic Bluetooth Camera Control | 119 |
| Monitor Settings | 57 | Blackmagic SDI and Bluetooth Camera Control Protocol | 121 |
| Audio Settings | 64 | Example Protocol Packets | 128 |
| Setup Settings | 66 | Help | 129 |
| Presets | 74 | Regulatory Notices | 130 |
| 3D LUTs | 76 | Safety Information | 131 |
| Entering Metadata | 79 | Warranty | 132 |
| Slate | 79 | | |
| Camera Video Output | 84 | | |
| Using DaVinci Resolve | 85 | | |

Which camera are you using?

Blackmagic Pocket Cinema Camera 6K and Blackmagic Pocket Cinema Camera 4K models have similar appearances. Both cameras produce incredible, wide dynamic range images and share the same chassis. The control buttons and software menus are laid out the same way, and operating the cameras is essentially the same.

Blackmagic Pocket Cinema Camera 6K features a Super 35mm sized sensor and an EF lens mount, and has a 6K icon above the lens mount. Blackmagic Pocket Cinema Camera 4K features a Micro Four Thirds sized sensor and a Micro Four Thirds lens mount.

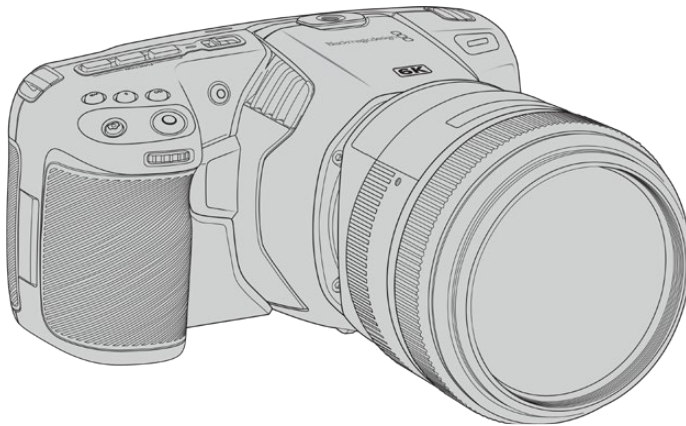

Blackmagic Pocket Cinema Camera 6K

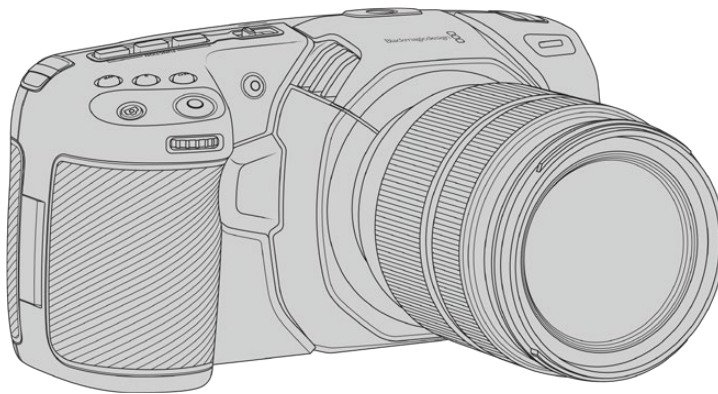

Blackmagic Pocket Cinema Camera 4K

Getting Started

Blackmagic Pocket Cinema Camera is a small portable digital cinema camera that records high quality images on CFast 2.0 and UHS-I and UHS-II SD cards or an SSD via the USB-C port. Your Pocket Cinema Camera is capable of recording clips using professional codecs designed for post production including Blackmagic RAW and ProRes.

Getting started with your Blackmagic Pocket Cinema Camera is as simple as mounting a lens and powering your camera.

Attaching a Lens

Blackmagic Pocket Cinema Camera 6K uses EF lenses and Blackmagic Pocket Cinema Camera 4K uses Micro Four Thirds lenses. Both of these types of lenses are very popular and affordable, plus there is an enormous range to choose from. Attaching a lens to your camera is the same process for Blackmagic Pocket Cinema Camera 6K and Pocket Cinema Camera 4K. In both cases, the first step is to remove the protective dust cap. To remove the protective dust cap, hold down the locking button and rotate the cap counterclockwise until it is released.

To attach an EF mount or Micro Four Thirds lens:

- 1 Align the dot on your lens with the dot on the camera mount. Many lenses have a visual indicator, for example a blue, red or white dot.
- 2 Press the lens mount against the camera mount, and twist the lens clockwise until it clicks into place.
- 3 To remove the lens, hold down the locking button, rotate the lens counterclockwise until its dot indicator reaches the 10 O'clock position on an MFT lens, or 12 o'clock for an EF lens. Gently remove the lens from its mount.

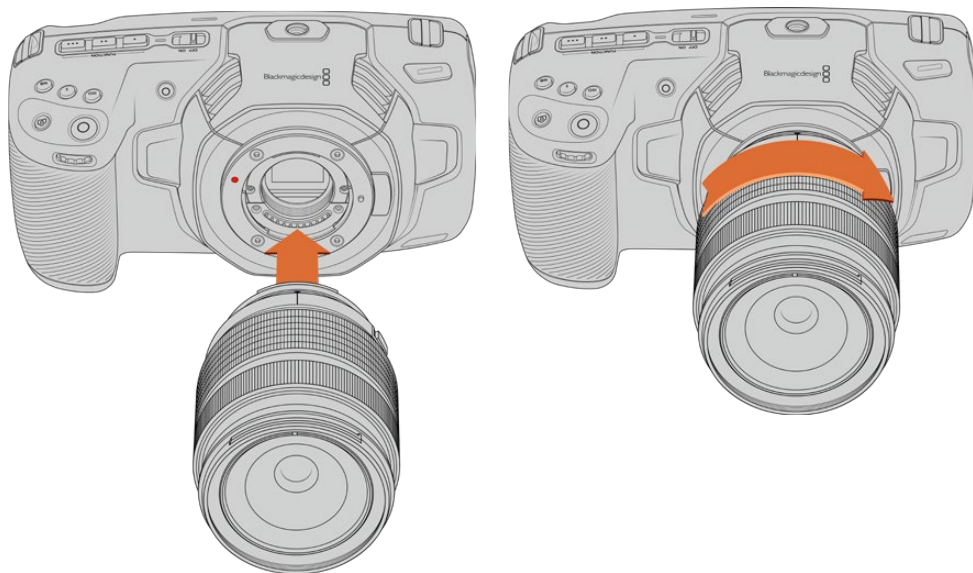

Attaching an MFT lens on Blackmagic Pocket Cinema Camera 4K

NOTE When no lens is attached to the camera, the glass filter covering the sensor is exposed to dust and other debris so you'll want to keep the dust cap on whenever possible.

Turning Your Camera On

Now that you've attached a lens, you will need to supply power to your camera. Blackmagic Pocket Cinema Camera can be powered by inserting an LP-E6 battery into the camera, or by plugging the supplied power adapter into the power input.

Inserting a Battery and Powering your Camera

Your camera uses standard removable LP-E6 type batteries. One is included with the camera, but if you need additional batteries, they can be purchased from your Blackmagic Design reseller or from most video or photography equipment stores.

- 1 On the underside of the camera, press the door release to open the battery door.
- 2 With the contacts facing the terminal, insert the LP-E6 type battery until you feel it click into place under the locking tab.

TIP To release the battery, push the locking tab towards the front of the camera and the battery will eject.

- 3 Close the door to the battery terminal and gently push until it clicks into place.
- 4 Move the power switch on the top of your camera to the 'on' position. To turn off the camera, move the power switch to the 'off' position.

Powering Your Camera with the Included Power Cable

The included 100-240 volt plug pack can be used to simultaneously power the camera and charge the LP-E6 battery. The DC power connector locks to the camera so it cannot be accidentally disconnected.

To plug in external power:

- 1 Connect the AC to 12V DC adapter plug to your mains power socket.
- 2 Open the rubber protector on the left side of your camera and rotate the locking DC power connector so that it lines up with the recess on the top of the 12V DC power input. Gently push the connector into the input until it clicks.
- 3 To unplug the connector, pull the sheath away from the connector and remove the connector from the input.

If you have both external and battery power connected, only external power is used. If you remove external power while a charged battery is connected, your camera switches to battery power without interruption.

Your camera's LP-E6 battery can be charged via USB when the camera is switched off. This is convenient as you can use a portable power bank to charge the camera when not in use. Blackmagic Pocket Cinema Camera supports charging via standard 10W USB wall chargers and can also be used with chargers that support USB-Power Delivery, or USB PD. USB PD chargers typically have a USB-C connection and up to 20V output, so can provide a faster charge. Charging the LP-E6 battery via the 12V DC power input is supported when the camera is switched on or off.

TIP If charging a hot battery immediately after use, charging speed is reduced until the battery cools below 45 degrees C or 113 degrees F. We recommend letting the battery cool down for 15 minutes before charging.

You are now ready to insert the storage media and start recording!

Storage Media

Your Blackmagic Pocket Cinema Camera uses standard SD cards, faster UHS-II SD cards or CFast 2.0 cards to record video.

Using the USB-C expansion port, you can also connect high capacity USB-C flash disks for increased recording times.

CFast Cards

CFast 2.0 cards are capable of supporting very high data rates, so are perfect for recording 6K, 4K and HD video at high frame rates. Refer to the record duration tables in the 'recording' section for details on the maximum frame rates that can be recorded in each format.

NOTE CFast 2.0 cards are generally high speed cards, though some cards have slower write speeds compared to read speeds, and maximum data rates can differ between models. For reliable recording with your chosen frame rates, use only the cards recommended by Blackmagic Design.

Inserting a CFast Card

To insert a CFast card:

- 1 Open the side door on the right side to access the media slots.
- 2 Insert the CFast card into the CFast card slot until you feel it lock into place. The card should insert easily without the need for excessive force. To remove a CFast card, gently push the CFast card towards the camera, then release to eject it.

The storage information at the bottom of the LCD touchscreen will show the name and record time remaining of the detected CFast card.

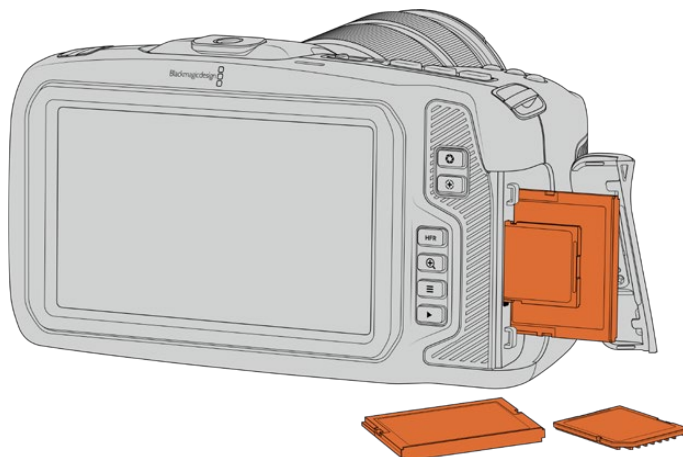

Choosing a CFast 2.0 Card

When working with high data rate video it's important to carefully check the CFast card that you would like to use. This is because CFast 2.0 cards have different read and write speeds.

For the most up to date information on supported CFast cards on Blackmagic Pocket Cinema Camera, please refer to the Blackmagic Design support center at www.blackmagicdesign.com/support.

The following CFast 2.0 cards are recommended for recording 4K DCI Blackmagic RAW 3:1 up to 60 fps on Blackmagic Pocket Cinema Camera 4K.

| Brand | Card Name | Storage |
|--------------------|--|---------|
| Angelbird | AV PRO CF | 512GB |
| Angelbird | AV PRO CF | 1TB |
| CinediskPro | 510MB/s CFast 2.0 | 256GB |
| Hagiwara Solutions | DC-SMAN64GA CFast 2.0 | 64GB |
| Hagiwara Solutions | DC-SMANA1GA CFast 2.0 | 128GB |
| KomputerBay | 3400x CFast 2.0 | 64GB |
| KomputerBay | 3400x CFast 2.0 | 128GB |
| Lexar | Professional 3400x CFast 2.0 | 128GB |
| Lexar | Professional 3500x CFast 2.0 | 256GB |
| ProGrade Digital | 550MB/s CFast 2.0 | 128GB |
| ProGrade Digital | 550MB/s CFast 2.0 | 256GB |
| ProGrade Digital | 550MB/s CFast 2.0 | 512GB |
| SanDisk | Extreme Pro CFast 2.0 SDCFSP-256G-x46D | 512GB |
| Wise | CFast 2.0 3400x | 128GB |
| Wise | CFast 2.0 3400x | 256GB |
| Wise | CFast 2.0 3500x | 512GB |

The following CFast 2.0 cards are recommended for recording 4K DCI ProRes HQ up to 60 fps on Blackmagic Pocket Cinema Camera 4K.

| Brand | Card Name | Storage |
|--------------------|--|---------|
| Angelbird | AV PRO CF | 128GB |
| Angelbird | AV PRO CF | 256GB |
| Angelbird | AV PRO CF | 512GB |
| CinediskPro | 510MB/s CFast 2.0 | 256GB |
| Hagiwara Solutions | DC-SMAN64GA CFast 2.0 | 64GB |
| Hagiwara Solutions | DC-SMANA1GA CFast 2.0 | 128GB |
| KomputerBay | 3400x CFast 2.0 | 128GB |
| ProGrade Digital | 550MB/s CFast 2.0 | 256GB |
| ProGrade Digital | 550MB/s CFast 2.0 | 512GB |
| SanDisk | Extreme Pro CFast 2.0 SDCFSP-64G-x46D | 64GB |
| SanDisk | Extreme Pro CFast 2.0 SDCFSP-128G-x46D | 128GB |
| SanDisk | Extreme Pro CFast 2.0 SDCFSP-256G-x46D | 256GB |
| Sony | CFast 2.0 G Series CAT-G64 | 64GB |
| Sony | CFast 2.0 G Series CAT-G128 | 128GB |
| Wise | CFast 2.0 3400x | 128GB |
| Wise | CFast 2.0 3400x | 256GB |
| Wise | CFast 2.0 3500x | 512GB |

SD Cards

In addition to CFast 2.0 cards, your camera can record on high speed UHS-I and UHS-II type SD cards. UHS-I SD cards allow you to use more affordable storage media when shooting compressed video formats in HD, and even faster UHS-II cards allow you to record Blackmagic RAW as well as Ultra HD content in ProRes.

With SD cards, you can use more affordable storage media when shooting compressed video formats in HD.

SDXC and SDHC are a very common media storage format for consumer still and video cameras. If you've ever shot video using a DSLR, or use a Blackmagic Micro Cinema Camera, Pocket Cinema Camera or Blackmagic Video Assist, you may already have compatible SD cards to use.

For projects that don't require the highest resolution files, or for when long recording durations are needed, using SD cards can be very economical. Lower capacity and lower speed SD cards can also be used for storing and loading LUTs and Presets.

Inserting an SD Card

To insert an SD Card:

- 1 Open the door on the right side to access the media slots.
- 2 With the label on the SD card facing the touchscreen, insert the SD card into the SD card slot until you feel it lock into place.

TIP To eject an SD card, push the SD card in then slide it out.

The storage information at the bottom of the LCD touchscreen shows the name and record time remaining of the detected SD card.

Choosing an SD Card

If you are recording 6K, 4K DCI or Ultra HD, then we recommend using the fastest high speed UHS-II type SD cards available. It's important to use high speed UHS-II SD cards for 6K, 4K DCI, Ultra HD and HD recording, or UHS-I cards for HD recording. These cards are rated for fast data speeds and support larger storage sizes. Generally the faster the cards, the better.

Before using your cards, you need to format them to either HFS+ or exFAT formats. It's easy to format your media via your camera's 'storage' settings. Refer to the 'settings' section for more information on storage settings.

If you want to, you can format your cards using a Mac or Windows computer. When using your media on macOS, you can use HFS+ which is the Mac disk format, also known as OS X Extended. If you are using Windows then you should use exFAT format, which is the Windows disk format that Mac computers can also read.

For the most up to date information on supported SD cards on Blackmagic Pocket Cinema Camera 6K, please refer to the Blackmagic Design support center at www.blackmagicdesign.com/support.

NOTE For high resolution, high frame rate recording, we recommend using CFast 2.0 media or an external USB-C flash disk, as they are typically faster and available in higher capacities.

The following SD cards are recommended for recording 4K DCI Blackmagic RAW 12:1 up to 30 fps on Blackmagic Pocket Cinema Camera 4K.

| Brand | Card Name | Storage |
|------------------|--|---------|
| Angelbird | AV PRO SD V90 | 64GB |
| Delkin Devices | Power UHS-II SDXC | 64GB |
| Delkin Devices | Power UHS-II SDXC | 128GB |
| Lexar | Professional 2000x UHS-II 300MB/s SDXC | 64GB |
| ProGrade Digital | V90 UHS-II 250MB/s SDXC | 256GB |
| SanDisk | Extreme Pro UHS-I 95MB/s SDXC | 512GB |
| Sony | SF-G64 300MB/s UHS-II SDXC | 64GB |
| Sony | Tough SF-G64T | 64GB |
| Sony | Tough SF-G128T | 128GB |
| Toshiba | Exceria Pro UHS-II N502 SDHC | 32GB |
| Toshiba | Exceria Pro UHS-II 270MB/s SDXC | 64GB |
| Wise | SDXC UHS-II | 64GB |
| Wise | SDXC UHS-II | 128GB |

The following SD cards are recommended for recording 4K DCI ProRes HQ up to 60 fps on Blackmagic Pocket Cinema Camera 4K.

| Brand | Card Name | Storage |
|-------|----------------|---------|
| Sony | Tough SF-G64T | 64GB |
| Sony | Tough SF-G128T | 128GB |
| Wise | SDXC UHS-II | 64GB |
| Wise | SDXC UHS-II | 128GB |

Locking and Unlocking SD Cards

SD cards can be write protected, or 'locked', to prevent data from being overwritten. When inserting an SD card, make sure the card is not write protected. To disable write protection, slide the plastic switch on the left side of the card to the position closest to the connectors. You can always set the card to the locked again after recording.



Move the lock tab up or down to lock or unlock an SD card

Your Blackmagic Pocket Cinema Camera lets you know if you've inserted a locked SD card by displaying the word 'locked' instead of the card's duration on the LCD touchscreen, and will display a padlock icon in the storage menu next to the card name. If the card is locked, you won't be able to record video, capture stills, or export LUTs and presets until it is unlocked.

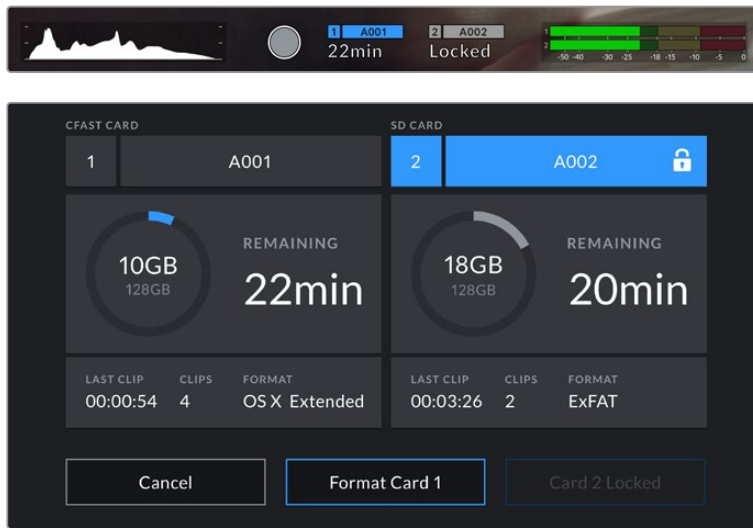

USB-C flash disks

Your Blackmagic Pocket Cinema Camera features a high speed USB-C expansion port, which allows you to record video directly to USB-C flash disks. These fast, high capacity drives allow you to record video for long periods, which can be important when filming events with long durations.

Once you have finished recording you can connect the same drive directly to your computer for editing and post production, without having to copy media across.

To connect to a USB-C flash disk:

- 1 Connect one end of a USB type-C cable to your USB-C flash disk.
- 2 Open the rubber protector on the left side of the camera and connect the other end of the cable to the USB-C port.

NOTE When a USB-C flash disk is connected to your camera, it occupies the same place as the SD card in your camera's operating system. This means that when you have a compatible USB-C flash disk connected, your camera's SD card slot is unavailable.

To use the SD card slot instead of the USB-C flash disk, disconnect the USB-C flash disk from your camera.

Choosing a fast USB-C flash disk

USB-C flash disks are designed to offer fast, affordable storage for a wide range of devices and are readily available from a variety of consumer electronics outlets. It's important to note that film making is only one part of the USB-C flash disk market, so choosing the best drive is vital to making sure you have enough speed to record 6K and 4K footage.

Many USB-C flash disks are designed for home computing and aren't fast enough to record 6K and 4K video. We highly recommend using only the USB-C flash disks from our recommended list. These USB-C flash disks have been tested with Blackmagic Pocket Cinema Camera to support continuous filming at the specified resolutions.

For the most up to date list of recommended USB-C flash disks please go to www.blackmagicdesign.com/support.

The following USB-C drives are recommended for recording 4K DCI ProRes HQ up to 60 fps.

| Brand | Card Name | Storage |
|-----------|----------------------|---------|
| Angelbird | SSD2GO PKT | 512GB |
| Angelbird | SSD2GO PKT | 2TB |
| Glyph | Atom | 500GB |
| Samsung | Portable SSD T5 | 500GB |
| Samsung | Portable SSD T5 | 1TB |
| SanDisk | Extreme Portable SSD | 1TB |
| Seagate | Fast SSD | 250GB |
| Wise | Portable SSD | 256GB |
| Wise | Portable SSD | 512GB |
| Wise | Portable SSD | 1TB |

The following USB-C drives are recommended for recording 4K DCI Blackmagic RAW 3:1 up to 60 fps.

| Brand | Card Name | Storage |
|--------------|--------------------|---------|
| Angelbird | SSD2GO PKT | 512GB |
| Angelbird | SSD2GO PKT | 2TB |
| G-Technology | G-DRIVE Mobile SSD | 1TB |
| Wise | Portable SSD | 512GB |

Important Notes About USB-C flash disk Speed

Some models of USB-C flash disk can't save video data at the speed the manufacturer claims. This is due to the disk using hidden data compression to attain higher write speeds. This data compression can only save data at the manufacturer's claimed speed when storing data such as blank data or simple files. Video data includes video noise and pixels which are more random so compression will not help, therefore revealing the true speed of the disk.

Some USB-C flash disks can have as much as 50% less write speed than the manufacturer's claimed speed. So even though the disk specifications claim a USB-C flash disk has speeds fast enough to handle video, in reality the disk isn't fast enough for real time video capture.

Use Blackmagic Disk Speed Test to accurately measure whether your USB-C flash disk will be able to handle high data rate video capture and playback. Blackmagic Disk Speed Test uses data to simulate the storage of video so you get results similar to what you'll see when capturing video to a disk. During Blackmagic testing, we have found newer, larger models of USB-C flash disk and larger capacity USB-C flash disks are generally faster.

Blackmagic Disk Speed Test is available from the Mac app store. Windows and macOS versions are also included in Blackmagic Desktop Video, which you can download from the 'capture and playback' section of the Blackmagic Design support center at www.blackmagicdesign.com/support.

Preparing Media for Recording

You can format your CFast cards, SD cards or USB-C flash disks using the 'format card' feature on your camera's storage and formatting menu, or via a Mac or Windows computer. For best performance, we recommend formatting storage media using your camera.

HFS+ is also known as OS X Extended and is the recommended format as it supports 'journaling'. Data on journaled media is more likely to be recovered in the rare event that your storage media becomes corrupted. HFS+ is natively supported by macOS. exFAT is supported natively by macOS and Windows without needing any additional software, but does not support journaling.

Preparing Media on Blackmagic Pocket Cinema Camera

- 1 Tap either storage indicator at the bottom of the LCD touchscreen to enter the storage manager.
- 2 Tap 'Format CFast card' or 'Format SD card'. If you have a USB-C flash disk connected to your camera, 'Format drive' will be displayed instead of 'Format SD card'.

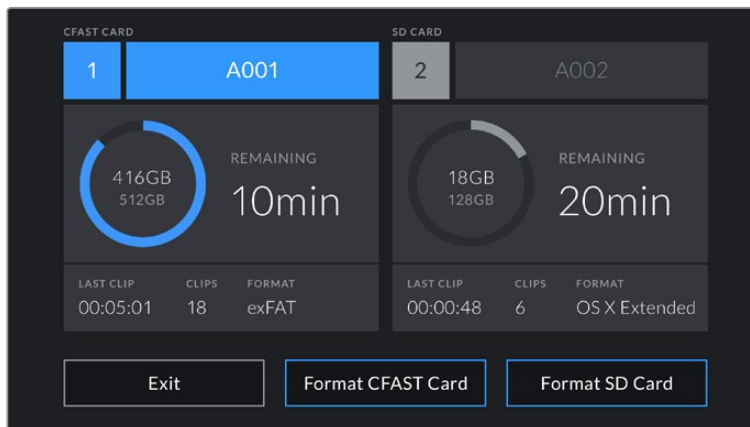

'Format SD card' is replaced with 'Format external drive' in your storage and formatting screen when you have a USB-C flash disk connected to your camera

- 3 Tap 'edit reel number' if you would like to manually change the reel number. Use the keypad to enter a new reel number and press 'update' to confirm your selection.
- 4 Choose OS X Extended or exFAT format and tap the format button.

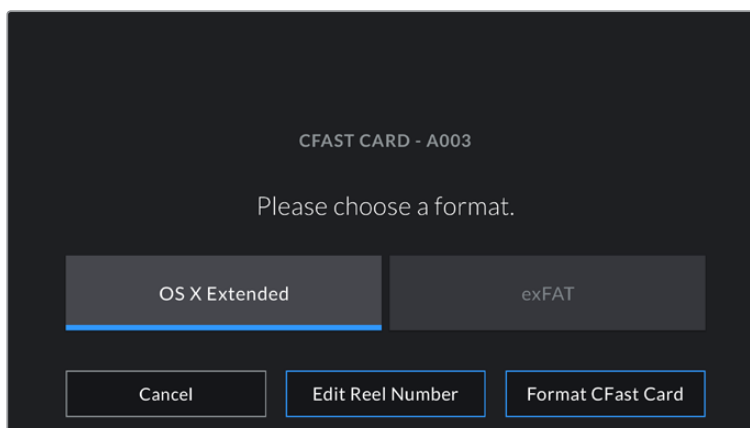

Tap 'edit reel number' to manually edit the reel number

- 5 A confirmation screen will allow you to confirm the card to be formatted, the selected format and the reel number. Confirm your selection by tapping the format button. Tap 'cancel' to cancel the format.

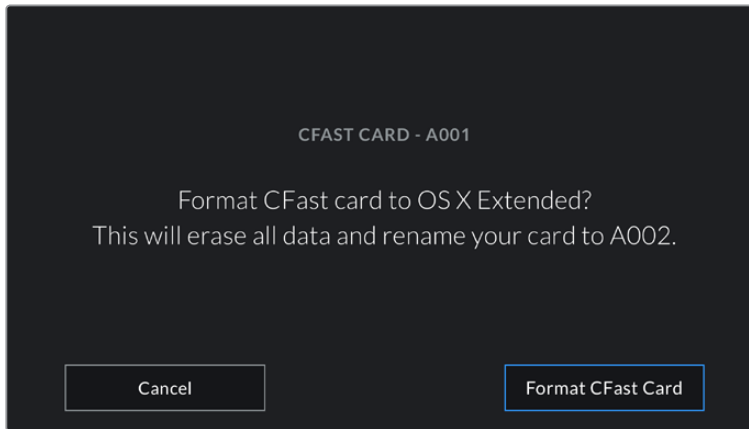

Check that you have selected the correct card before formatting

- 6 Hold down the format button for three seconds to format your media.

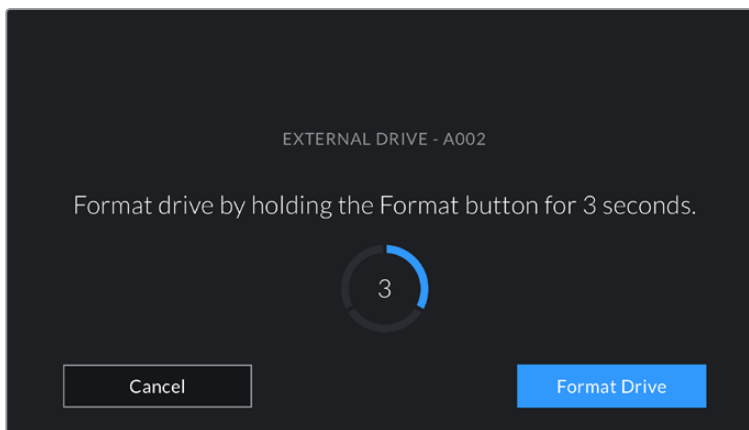

- 7 The camera notifies you when the format is complete and your drive is ready for use, or if formatting has failed.
- 8 Tap 'ok' to return to the storage manager.
- 9 Tap 'exit' to leave the storage manager.

When formatting CFast cards, SD cards or USB-C flash disks using your camera, the camera ID that is generated from the slate and reel number are used to name the media. Your camera automatically adjusts the reel numbers incrementally each time you format. If you need to manually enter a specific reel number, tap the 'edit reel number' and enter the number you want to format the card as.

Tap on 'reset project data' in the 'project' tab of the slate if you're starting a new project and want the numbering to reset back to 1.



The storage manager on your camera indicates whether you are currently managing CFast, SD or USB-C flash disk media

TIP If the SD card is write protected, your camera will display the word 'locked' instead of the card's duration on the LCD touchscreen, and will display a padlock icon in the storage menu. Unlock the card to format and record. For more information, refer to the 'SD cards' section of this manual.

NOTE If you have a USB-C flash disk connected, 'external drive' appears over storage slot 2.

Preparing Media on a Mac

Use the Disk Utility application included with macOS to format your CFast card, SD card, or USB-C flash disk in the HFS+ or exFAT formats. Remember to backup anything important from your media first as all data will be lost when it is formatted.

- 1 Connect the storage media to your computer and dismiss any message offering to use your media for Time Machine backups.
- 2 Go to applications/utilities and launch Disk Utility.
- 3 Click on the disk icon for your camera's storage media and then click the 'erase' tab.
- 4 Set the 'format' to 'Mac OS extended (journaled)' or 'exFAT'.
- 5 Type a 'name' for the new volume and then click 'erase'. Your camera's storage media will quickly be formatted and made ready for use.

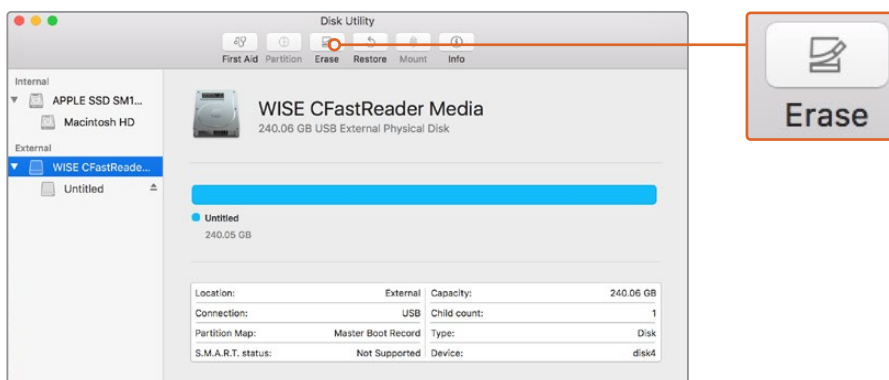

Use Disk Utility on macOS to erase your camera's storage media in the Mac OS extended (journaled) or exFAT format

Preparing Media on Windows

The 'format' dialog box can format your camera's storage media in the exFAT format on a Windows PC. Remember to backup anything important from your media first as all data will be lost when it is formatted.

- 1 Connect your camera's storage media to your computer using an external reader, USB-C cable or adapter.
- 2 Open the 'start' menu or 'start' screen and choose 'computer'. Right click on your camera's storage media.
- 3 From the contextual menu, choose 'format'.
- 4 Set the file system to 'exFAT' and the allocation unit size to 128 kilobytes.
- 5 Type a volume label, select 'quick format' and click 'start'.
- 6 Your storage media will quickly be formatted and made ready for use.

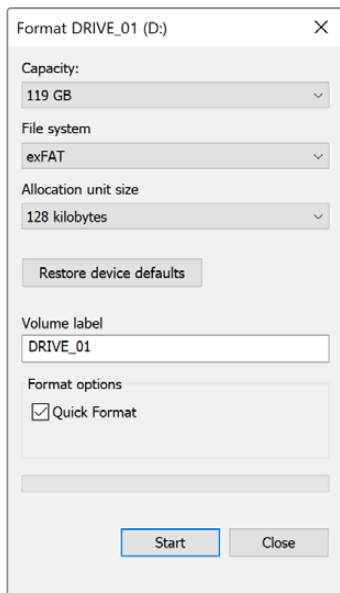

Use the 'format' dialog box feature in Windows to format your camera's storage media in the exFAT format

NOTE If your recordings are dropping frames, check that your card or drive is on our list of recommended media for the codec and frame size you are using. For lower data rates try lowering your frame rate, resolution, or try a compressed codec such as ProRes. Check the Blackmagic Design website for the latest information at www.blackmagicdesign.com

NOTE Partitioned media can be used with your Blackmagic Pocket Cinema Camera, though your camera will only recognize the first partition of your media for recording and playback.

It's worth noting that if you use the storage and formatting menu to format your media, the entire drive including all partitions will be erased, not just the first partition that has been used for recording and playback. For this reason we strongly recommend using media with one partition only.

Recording

Recording Clips

Blackmagic Pocket Cinema Camera features two record buttons. The primary record button is located on the top of the handgrip for triggering with your index finger when holding the handgrip of the camera with your right hand.

The second record button is located on the front of your camera to allow you to begin recording while holding the camera with one hand in situations where you want to record yourself. The button is located in an easy to reach position, ideal if you are recording yourself for video blogs.

Press one of the 'record' buttons on your camera to begin recording immediately. Press 'record' again to stop recording.

Before you start recording, tap and hold the name of the media at the bottom of the touchscreen to select the memory card or USB-C flash disk you want to use. The bar over the media type you have selected turns blue to indicate the camera is set to record to this media. To record to a different card or drive, tap and hold the name of the media. While recording, the bar is red.

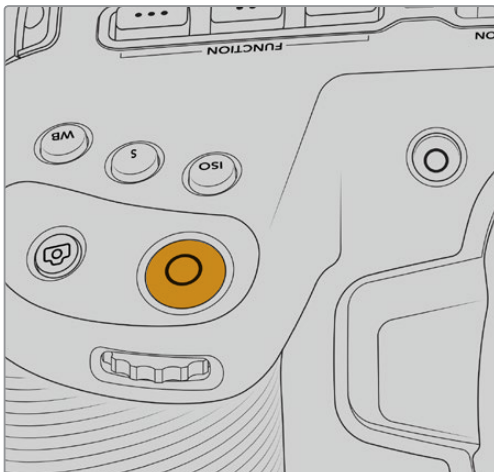

The 'record' button located on the top panel of your camera

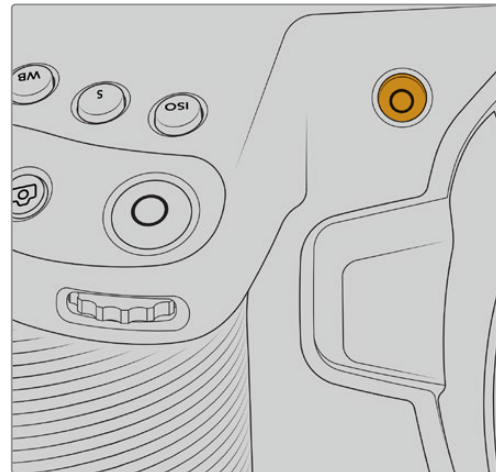

The 'record' button located on the front of your camera

Choosing the Recording Format

Blackmagic Pocket Cinema Camera records using Apple ProRes codecs including ProRes 422 HQ, ProRes 422, ProRes 422 LT and ProRes 422 Proxy. ProRes codecs let you fit more video on your SD card, CFast card or USB-C flash disk. ProRes 422 HQ provides the highest quality video with the lowest compression. Alternatively, ProRes 422 Proxy gives you far more recording time with greater compression. Your camera can also record with the Blackmagic RAW format. You may decide to experiment to see which format best suits your workflow.

It's important to note that Blackmagic Pocket Cinema Camera 6K uses Blackmagic RAW for full sensor and windowed sensor formats, and ProRes for scaled formats. For more information on windowed and scaled formats, see the 'Blackmagic Pocket Cinema Camera 6K Maximum Sensor Frame Rates' section.

Blackmagic RAW

Blackmagic Pocket Cinema Camera supports the Blackmagic RAW file format. This format offers superior image quality, wide dynamic range and a broad selection of compression ratios. Blackmagic RAW features all the user benefits of RAW recording, but the files are very fast because most of the processing is performed in the camera where it can be hardware accelerated by the camera itself. This means that Blackmagic RAW plays back at normal speed on most computers, without needing to cache it first or lower the resolution.

Blackmagic RAW also includes powerful metadata support so the software reading the files knows your camera settings. If you like shooting in video gamma because you need to turn around edits quickly and you don't have time for color correction, then this metadata feature means you can select video gamma, shoot in video gamma, and the file will display with video gamma applied when you open it in software. However underneath, the file is actually film gamma and the metadata in the file is what's telling the software to apply the video gamma.

So what all this means is if you want to color grade your images at some point, then you have all that film dynamic range preserved in the file. You don't have your images hard clipped in the whites or the blacks, so you retain detail and you can color grade to make all your images look cinematic. However, if you don't have time for color grading, that's fine because your images will have the video gamma applied and look like normal video camera images. You are not locked in on the shoot and you can change your mind later during post production.

Blackmagic RAW files are extremely fast and the codec is optimized for your computer's CPU and GPU. This means it has fast smooth playback and eliminates the need for hardware decoder boards, which is important for laptop use. Software that reads Blackmagic RAW also gets the advantage of processing via Apple Metal, Nvidia CUDA and OpenCL.

This means that Blackmagic RAW plays back at normal speed like a video file on most computers, without needing to cache it first or lower the resolution.

It's also worth mentioning that lens information is recorded in the metadata on a frame by frame basis. For example, when using compatible lenses, any zoom or focus changes performed over the length of a clip will be saved, frame by frame, to the metadata in the Blackmagic RAW file.

Recording to Blackmagic RAW

Blackmagic RAW works in 2 different ways. You have a choice to use either the constant bitrate codec, or the constant quality codec.

The constant bitrate codec works in a similar way to most codecs. It tries to keep the data rate at a consistent level and won't let the data rate go too high. This means even if you are shooting a complex image that might need a bit more data to store the image, a constant bitrate codec will just compress the image harder to make sure the images fit within the space allocated.

This can be fine for video codecs, however when shooting Blackmagic RAW you really want to ensure the quality is predictable. What would happen if the images you were shooting needed more data, but the codec just compresses harder to make a specified data rate? It's possible you could lose quality, but not be sure it's happening until you return from a shoot.

To solve this problem, Blackmagic RAW also has an alternative codec choice called constant quality. This codec is technically called a variable bitrate codec, but what it's really doing is allowing the size of the file to grow if your images need extra data. There is no upper limit on the file size if you need to encode an image but maintain quality.

So Blackmagic RAW set to the constant quality setting will just let the file grow as big as it needs to be to encode your images. It also means the files could be larger or smaller depending on what you are shooting. I guess if you leave your lens cap on the lens, you won't waste space on your media!

It is also worth noting that the quality settings for Blackmagic RAW are not obscure names, but are more meaningful as they are derived from what's happening technically. So for example when you have selected the constant bitrate codec, you will see quality settings of 3:1, 5:1, 8:1 and 12:1. These are the ratios of the uncompressed RAW file size vs the file sizes you should expect when shooting in Blackmagic RAW. 3:1 is better quality as the file is larger, while 12:1 is the smallest file size with the lowest quality. Many users of Blackmagic RAW find that 12:1 has been perfectly ok and they have not seen any quality limitations. However it's best to experiment and try various settings for yourself.

When using Blackmagic RAW in constant quality you will see the settings are Q0 and Q5. These are the compression parameters passed to the codec and they are setting how much compression is applied in a more technical way. This setting is different because the codec operates differently between constant bitrate vs constant quality. In this constant quality setting, you really cannot tell what the file size ratio will become as it varies a lot based on what you are shooting. So in this case the setting is different and the file will become the size needed to store your media.

Constant Bitrate Settings

The names for 3:1, 5:1, 8:1 and 12:1 represent the compression ratio. For example, 12:1 compression produces a file size roughly 12 times smaller than uncompressed RAW.

Constant Quality Settings

Q0 and Q5 refer to different levels of quantization. Q5 has a greater level of quantization but offers a greatly improved data rate. As mentioned above, the constant quality setting can result in files that grow and shrink quite a lot, depending on what you are shooting. This also means it's possible to shoot something and see the file size increase to beyond what your media card can keep up with. It could result in dropped frames. However the benefit is that you can instantly see if this happens on a shoot and then investigate your settings vs quality.

Blackmagic RAW Player

The Blackmagic RAW player included in your Blackmagic camera's software installer is a streamlined application for reviewing clips. Simply double click on a Blackmagic RAW file to open it, and you can quickly play and scroll through the file with its full resolution and bit depth.

When decoding frames, the CPU acceleration in the SDK library supports all main architectures, and also supports GPU acceleration via Apple Metal, Nvidia CUDA and OpenCL. It also works with the Blackmagic eGPU for extra performance. Blackmagic RAW player is currently available on macOS and will be available for Windows in an upcoming release.

Sidecar Files

Blackmagic RAW sidecar files let you override metadata in a file without overwriting embedded metadata in the original file. This metadata includes the Blackmagic RAW settings as well as information on iris, focus, focal length, white balance, tint, color space, project name, take number and more. Metadata is encoded frame by frame over the duration of the clip, which is important for lens data if the lens is adjusted during a shot. You can add or edit metadata in sidecar files with DaVinci Resolve or even a text editor because it's a human readable format.

Sidecar files can be used to automatically add new Blackmagic RAW settings to a playback simply by moving the sidecar file into the same folder as the corresponding Blackmagic RAW file. If you move the sidecar file out of the folder and reopen the Blackmagic RAW file, the changed settings are not applied and you see the file as it was originally shot. Any software that uses the Blackmagic RAW SDK can access these settings. Changes made are saved in the sidecar file and can then be seen by Blackmagic RAW Player or any other software capable of reading Blackmagic RAW files.

When shooting video gamma, the file stays in film gamma, and the metadata tells the Blackmagic RAW processing to display using video gamma. Video gamma is great when you don't want to grade the image and want to deliver content quickly, however if you want to pull up the black parts of the image, or pull down the white areas, all the detail is retained. You never clip the video and all the detail is still there if you want to access it at any time.

Blackmagic RAW in DaVinci Resolve

Settings can be adjusted for each Blackmagic RAW file, and then saved as a new sidecar file from the 'Camera RAW' tab in DaVinci Resolve for creative effect or optimized viewing. This also means you can copy your media for another DaVinci Resolve artist and they will have access to your modified gamma settings automatically on import. In addition to the other metadata your camera files contain, DaVinci Resolve can read your selected dynamic range, so your clips will automatically display in DaVinci Resolve with 'film', 'extended video' or 'video' dynamic range.

You can then customize these settings by adjusting the saturation, contrast and midpoint, as well as the highlight and shadow rolloff. Any adjustments can then be saved as a sidecar file, so the changes can be seen by anyone else working with the files in post. You can always return to the original camera metadata at any time.

You can also export a single Blackmagic RAW frame from the 'Camera RAW' tab in DaVinci Resolve, which contains all adjustments, metadata, full resolution and color information so it is easy to share a single frame grab or reference file with others.

For more information on how to use Blackmagic RAW in DaVinci Resolve, see the 'Using DaVinci Resolve' chapter in this manual.

Blackmagic RAW Software Development Kit

The Blackmagic RAW Software Development Kit is an API developed by Blackmagic Design. You can use the Blackmagic RAW SDK to write your own applications to use the Blackmagic RAW format. This SDK library can be used by any developer to add support for reading, editing, and saving Blackmagic RAW files. The Blackmagic RAW SDK includes all the generation 4 color science so you can achieve organic cinematic images across any app that supports it. The Blackmagic RAW SDK supports Mac, Windows and Linux, and is available as a free download from the developer page of the Blackmagic website at www.blackmagicdesign.com/developer

The following diagram illustrates the components of the Blackmagic RAW API:

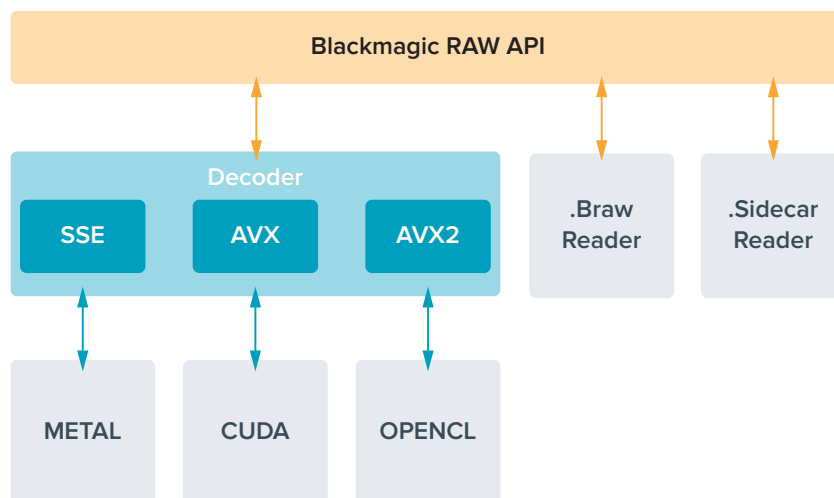

Blackmagic Pocket Cinema Camera 6K Maximum Sensor Frame Rates

This table contains available codecs, resolutions and their maximum sensor frame rates for Blackmagic Pocket Cinema Camera 6K.

| | Resolution | Codec | Sensor Scan | Max Frame Rate |
|------------------------|-------------|------------------|------------------|----------------|
| 6K | 6144 x 3456 | Blackmagic RAW | Full | 50 |
| 6K 2.4:1 | 6144 x 2560 | Blackmagic RAW | Window | 60 |
| 5.7K 17:9 | 5744 x 3024 | Blackmagic RAW | Window | 60 |
| 4K DCI | 4096 x 2160 | ProRes 422 HQ | Scaled from 5.7K | 60 |
| | 4096 x 2160 | ProRes 422 | Scaled from 5.7K | 60 |
| | 4096 x 2160 | ProRes 422 LT | Scaled from 5.7K | 60 |
| | 4096 x 2160 | ProRes 422 Proxy | Scaled from 5.7K | 60 |
| Ultra HD | 3840 x 2160 | ProRes 422 HQ | Scaled from full | 50 |
| | 3840 x 2160 | ProRes 422 | Scaled from full | 50 |
| | 3840 x 2160 | ProRes 422 LT | Scaled from full | 50 |
| | 3840 x 2160 | ProRes 422 Proxy | Scaled from full | 50 |
| | 3840 x 2160 | ProRes 422 HQ | Scaled from 5.7K | 60 |
| | 3840 x 2160 | ProRes 422 | Scaled from 5.7K | 60 |
| | 3840 x 2160 | ProRes 422 LT | Scaled from 5.7K | 60 |
| | 3840 x 2160 | ProRes 422 Proxy | Scaled from 5.7K | 60 |
| 3.7K Anamorphic | 3728 x 3104 | Blackmagic RAW | Window | 60 |
| 2.8K 17:9 | 2868 x 1512 | Blackmagic RAW | Window | 120 |
| HD | 1920 x 1080 | ProRes 422 HQ | Scaled from full | 50 |
| | 1920 x 1080 | ProRes 422 | Scaled from full | 50 |
| | 1920 x 1080 | ProRes 422 LT | Scaled from full | 50 |
| | 1920 x 1080 | ProRes 422 Proxy | Scaled from full | 50 |
| | 1920 x 1080 | ProRes 422 HQ | Scaled from 5.7K | 60 |
| | 1920 x 1080 | ProRes 422 | Scaled from 5.7K | 60 |
| | 1920 x 1080 | ProRes 422 LT | Scaled from 5.7K | 60 |
| | 1920 x 1080 | ProRes 422 Proxy | Scaled from 5.7K | 60 |
| | 1920 x 1080 | ProRes 422 HQ | Scaled from 2.7K | 120 |
| | 1920 x 1080 | ProRes 422 | Scaled from 2.7K | 120 |
| | 1920 x 1080 | ProRes 422 LT | Scaled from 2.7K | 120 |
| | 1920 x 1080 | ProRes 422 Proxy | Scaled from 2.7K | 120 |

Blackmagic Pocket Cinema Camera 4K Maximum Sensor Frame Rates

This table contains available codecs, resolutions and their maximum sensor frame rates for Blackmagic Pocket Cinema Camera 4K.

| | Resolution | Codec | Sensor Scan | Max Frame Rate |
|-----------------|-------------|------------------|------------------|----------------|
| 4K DCI | 4096 x 2160 | Blackmagic RAW | Full | 60 |
| | 4096 x 2160 | ProRes 422 HQ | Full | 60 |
| | 4096 x 2160 | ProRes 422 | Full | 60 |
| | 4096 x 2160 | ProRes 422 LT | Full | 60 |
| | 4096 x 2160 | ProRes 422 Proxy | Full | 60 |
| Ultra HD | 3840 x 2160 | Blackmagic RAW | Window | 60 |
| | 3840 x 2160 | ProRes 422 HQ | Window | 60 |
| | 3840 x 2160 | ProRes 422 | Window | 60 |
| | 3840 x 2160 | ProRes 422 LT | Window | 60 |
| | 3840 x 2160 | ProRes 422 Proxy | Window | 60 |
| HD | 1920 x 1080 | ProRes 422 HQ | Scaled from full | 60 |
| | 1920 x 1080 | ProRes 422 | Scaled from full | 60 |
| | 1920 x 1080 | ProRes 422 LT | Scaled from full | 60 |
| | 1920 x 1080 | ProRes 422 Proxy | Scaled from full | 60 |
| | 1920 x 1080 | Blackmagic RAW | Window | 120 |
| | 1920 x 1080 | ProRes 422 HQ | Window | 120 |
| | 1920 x 1080 | ProRes 422 | Window | 120 |
| | 1920 x 1080 | ProRes 422 LT | Window | 120 |
| | 1920 x 1080 | ProRes 422 Proxy | Window | 120 |

Record Duration

These tables show approximate record duration in minutes and seconds based on format, project frame rate and media size. It's important to note that available resolutions and codecs differ for Pocket Cinema Camera 6K and Pocket Cinema Camera 4K.

The maximum recording time for your storage media can vary depending on the data capacity your CFast card, SD card or USB-C flash disk, and the recording format and frame rate you choose. For example, the storage rate for Apple ProRes 422 HQ at 3840 x 2160 is approximately 880 Mbps. At 24 frames per second, you can record approximately 47 minutes of video on a 256GB CFast 2.0 card. At the same settings you can record approximately 23 minutes of video on a 128GB CFast card, which is approximately half the record duration of a 256GB CFast card.

It should be noted that recording duration of media can vary slightly between different manufacturers. It can also vary depending on whether the storage media is formatted as exFAT or Mac OS X Extended.

Simple scenes containing less detail tend to require less data than more dense compositions. The values in these tables assume shots with a high complexity, which means you may get slightly longer record times depending on the nature of your shoot.

| 6K | | | | | |
|------------|------------|--------------------|--------------------|--------------------|---------------------|
| CFast Card | Frame Rate | Blackmagic RAW 3:1 | Blackmagic RAW 5:1 | Blackmagic RAW 8:1 | Blackmagic RAW 12:1 |
| 256GB | | Duration | Duration | Duration | Duration |
| | 23.98 | 17 mins | 28 mins | 45 mins | 67 mins |
| | 24 | 17 mins | 28 mins | 45 mins | 67 mins |
| | 25 | 16 mins | 27 mins | 43 mins | 64 mins |
| | 30 | 13 mins | 22 mins | 36 mins | 54 mins |
| | 50 | 8 mins | 13 mins | 21 mins | 32 mins |

| 6K 2.4:1 | | | | | |
|------------|------------|--------------------|--------------------|--------------------|---------------------|
| CFast Card | Frame Rate | Blackmagic RAW 3:1 | Blackmagic RAW 5:1 | Blackmagic RAW 8:1 | Blackmagic RAW 12:1 |
| 256GB | | Duration | Duration | Duration | Duration |
| | 23.98 | 23 mins | 38 mins | 60 mins | 91 mins |
| | 24 | 22 mins | 38 mins | 60 mins | 91 mins |
| | 25 | 21 mins | 36 mins | 58 mins | 87 mins |
| | 30 | 18 mins | 30 mins | 48 mins | 72 mins |
| | 50 | 11 mins | 18 mins | 29 mins | 43 mins |
| | 60 | 9 mins | 15 mins | 24 mins | 36 mins |

| 5.7K 17:9 | | | | | |
|------------|------------|--------------------|--------------------|--------------------|---------------------|
| CFast Card | Frame Rate | Blackmagic RAW 3:1 | Blackmagic RAW 5:1 | Blackmagic RAW 8:1 | Blackmagic RAW 12:1 |
| 256GB | | Duration | Duration | Duration | Duration |
| | 23.98 | 20 mins | 34 mins | 55 mins | 82 mins |
| | 24 | 20 mins | 34 mins | 55 mins | 82 mins |
| | 25 | 19 mins | 33 mins | 52 mins | 79 mins |
| | 30 | 16 mins | 27 mins | 44 mins | 66 mins |
| | 50 | 10 mins | 16 mins | 26 mins | 39 mins |
| | 60 | 8 mins | 13 mins | 22 mins | 33 mins |

| 4K DCI | | | | | | | | | |
|------------|------------|--------------------|--------------------|--------------------|---------------------|---------------|------------|---------------|------------------|
| CFast Card | Frame Rate | Blackmagic RAW 3:1 | Blackmagic RAW 5:1 | Blackmagic RAW 8:1 | Blackmagic RAW 12:1 | ProRes 422 HQ | ProRes 422 | ProRes 422 LT | ProRes 422 Proxy |
| 256GB | | Duration | Duration | Duration | Duration | Duration | Duration | Duration | Duration |
| | 23.98 | 39 mins | 65 mins | 104 mins | 155 mins | 44 mins | 66 mins | 95 mins | 216 mins |
| | 24 | 39 mins | 65 mins | 103 mins | 155 mins | 44 mins | 66 mins | 95 mins | 216 mins |
| | 25 | 37 mins | 62 mins | 99 mins | 149 mins | 42 mins | 64 mins | 91 mins | 207 mins |
| | 30 | 31 mins | 52 mins | 83 mins | 124 mins | 35 mins | 53 mins | 76 mins | 173 mins |
| | 50 | 18 mins | 31 mins | 49 mins | 74 mins | 21 mins | 32 mins | 45 mins | 104 mins |
| | 60 | 15 mins | 26 mins | 41 mins | 62 mins | 17 mins | 26 mins | 38 mins | 87 mins |

| ULTRA HD | | | | | | | | | |
|------------|------------|--------------------|--------------------|--------------------|---------------------|---------------|------------|---------------|------------------|
| CFast Card | Frame Rate | Blackmagic RAW 3:1 | Blackmagic RAW 5:1 | Blackmagic RAW 8:1 | Blackmagic RAW 12:1 | ProRes 422 HQ | ProRes 422 | ProRes 422 LT | ProRes 422 Proxy |
| 256GB | | Duration | Duration | Duration | Duration | Duration | Duration | Duration | Duration |
| | 23.98 | 41 mins | 68 mins | 110 mins | 164 mins | 47 mins | 71 mins | 101 mins | 230 mins |
| | 24 | 41 mins | 68 mins | 109 mins | 164 mins | 47 mins | 71 mins | 101 mins | 230 mins |
| | 25 | 39 mins | 66 mins | 105 mins | 157 mins | 45 mins | 68 mins | 97 mins | 221 mins |
| | 30 | 33 mins | 55 mins | 88 mins | 131 mins | 38 mins | 57 mins | 81 mins | 184 mins |
| | 50 | 19 mins | 33 mins | 52 mins | 79 mins | 22 mins | 34 mins | 48 mins | 111 mins |
| | 60 | 16 mins | 27 mins | 44 mins | 66 mins | 18 mins | 28 mins | 40 mins | 92 mins |

| 3.7K Anamorphic | | | | | |
|-----------------|------------|--------------------|--------------------|--------------------|---------------------|
| CFast Card | Frame Rate | Blackmagic RAW 3:1 | Blackmagic RAW 5:1 | Blackmagic RAW 8:1 | Blackmagic RAW 12:1 |
| 256GB | | Duration | Duration | Duration | Duration |
| | 23.98 | 31 mins | 51 mins | 82 mins | 123 mins |
| | 24 | 31 mins | 51 mins | 82 mins | 123 mins |
| | 25 | 29 mins | 49 mins | 79 mins | 118 mins |
| | 30 | 24 mins | 41 mins | 65 mins | 98 mins |
| | 50 | 15 mins | 24 mins | 39 mins | 59 mins |
| | 60 | 12 mins | 20 mins | 33 mins | 49 mins |

| 2.8K 17:9 | | | | | |
|------------|------------|--------------------|--------------------|--------------------|---------------------|
| CFast Card | Frame Rate | Blackmagic RAW 3:1 | Blackmagic RAW 5:1 | Blackmagic RAW 8:1 | Blackmagic RAW 12:1 |
| 256GB | | Duration | Duration | Duration | Duration |
| | 23.98 | 81 mins | 136 mins | 216 mins | 321 mins |
| | 24 | 81 mins | 135 mins | 215 mins | 320 mins |
| | 25 | 78 mins | 130 mins | 207 mins | 308 mins |
| | 30 | 65 mins | 108 mins | 173 mins | 258 mins |
| | 50 | 39 mins | 65 mins | 104 mins | 156 mins |
| | 60 | 32 mins | 54 mins | 87 mins | 130 mins |
| | 120 | 16 mins | 27 mins | 43 mins | 65 mins |

| HD | | | | | | | | | |
|------------|------------|--------------------|--------------------|--------------------|---------------------|---------------|------------|---------------|------------------|
| CFast Card | Frame Rate | Blackmagic RAW 3:1 | Blackmagic RAW 5:1 | Blackmagic RAW 8:1 | Blackmagic RAW 12:1 | ProRes 422 HQ | ProRes 422 | ProRes 422 LT | ProRes 422 Proxy |
| 256GB | | Duration | Duration | Duration | Duration | Duration | Duration | Duration | Duration |
| | 23.98 | 159 mins | 264 mins | 418 mins | 619 mins | 189 mins | 283 mins | 403 mins | 877 mins |
| | 24 | 159 mins | 264 mins | 418 mins | 618 mins | 189 mins | 283 mins | 403 mins | 877 mins |
| | 25 | 153 mins | 253 mins | 402 mins | 595 mins | 182 mins | 271 mins | 387 mins | 843 mins |
| | 30 | 127 mins | 212 mins | 336 mins | 499 mins | 152 mins | 227 mins | 324 mins | 710 mins |
| | 50 | 76 mins | 127 mins | 203 mins | 303 mins | 91 mins | 137 mins | 196 mins | 434 mins |
| | 60 | 64 mins | 106 mins | 170 mins | 254 mins | 76 mins | 114 mins | 163 mins | 363 mins |
| | 120 | 32 mins | 54 mins | 87 mins | 130 mins | 38 mins | 57 mins | 82 mins | 185 mins |

NOTE It's important to note that 6K, 6K 2.4:1, 5.7K 17:9, 3.7K Anamorphic and 2.8K 17:9 formats are available on Blackmagic Pocket Cinema Camera 6K only. Blackmagic Pocket Cinema Camera 6K uses ProRes for 4K DCI, Ultra HD and HD formats.

Constant quality settings for Q0 and Q5 will display varying record time remaining durations. The estimated duration for Q0 is similar to constant bitrate 3:1, and Q5 will display a similar duration to 12:1, however, as the estimated duration updates every 10 seconds while recording, the best way to gauge how much recording time you have is to record for 20 seconds and monitor the duration in the media area of the touchscreen display.

Choosing Frame Rates

Your camera is able to shoot video using many different frame rates and you may be wondering which is the best one to use.

Generally, when selecting a sensor frame rate, there are some common items to consider. For many years, there have been presentation standards for film and television. These have set frame rates that differ between countries, but all share the same purpose; to display an efficient number of frames every second that portrays pleasing and convincing motion.

Cinema, for example, uses a standard 24 frames per second and while there have been recent experiments with faster frame rates, 24 frames per second remains widely accepted for international audiences.

Television frame rates have generally conformed to technical broadcast standards for each country. For example, if you were making television content you would typically record using 29.97 frames per second for North American distribution, and 25 frames per second for Europe.

However, as technology has improved, today we have more choices and broadcast standards are changing. It is now common for sporting events to be recorded and broadcasted at higher frame rates. For example, some sporting events are recorded and broadcasted at up to 59.94 frames per second in North America, and 50 frames per second in Europe. This provides smoother motion on fast action and appears more lifelike.

Alternatively, streaming and online broadcasters normally use frame rates similar to television, however there is more freedom to experiment due to user selectable viewing formats, and being limited only to what the audience's screens are capable of displaying.

Generally, when choosing a frame rate for a project, let your delivery format guide your choice. Your camera's project frame rate should be set to this, and your sensor frame should be set to 'match'. This means your clips will play back at the same speed the event happened in real life.

If you are looking to create an interesting effect, for example slow motion, then you can set the sensor frame rate to a higher setting. The higher the sensor frame rate compared to the project frame rate, the slower the playback speed.

For more information on using off speed sensor frame rates to achieve creative effects, refer to the 'touchscreen controls' section.

Trigger Record

Blackmagic Pocket Cinema Camera automatically sends a signal via the HDMI output that will trigger recording when connected to equipment that supports the trigger record feature, such as Blackmagic Video Assist.

This means that when you press record on your camera, your external recorder also starts recording and stops when you stop recording on the camera. Your camera also outputs timecode via HDMI, which means the clips recorded on your external recorder has the same timecode as the clips recorded in your camera.

If your external recorder supports trigger recording, you will need to enable it. This can usually be enabled via its settings menu.

Playback

Playing Back Clips

Once you have recorded your video, you can use the transport control buttons to play back your video on the LCD. Press the play button to switch to playback mode. Press the button again for instant playback of the last recorded clip on the LCD, and on any display connected to the HDMI output. Hold down the forward or reverse buttons on the LCD to fast forward or reverse through the clip. Playback will finish when the end of the current clip is reached.

Press the forward and reverse buttons to skip to the start or end of clips. Press the reverse button once to go to the start of the current clip or press twice to skip back to the start of the previous clip. Press the record button to exit playback and return the touchscreen to the camera view.

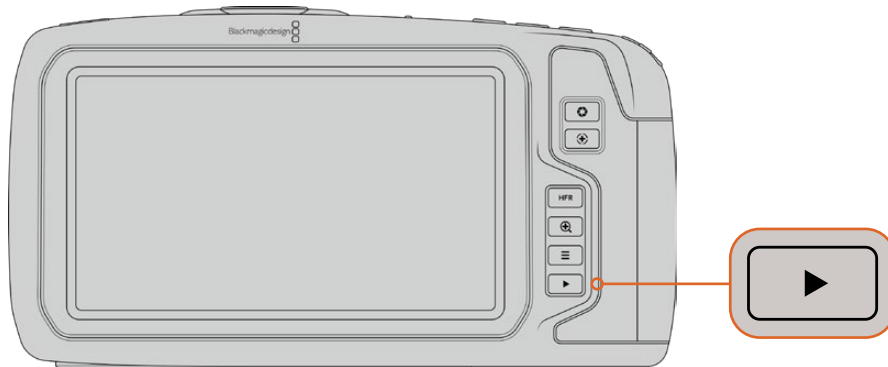

To view your most recently recorded clip on the built in touchscreen, press the 'play' button on the transport controls

Camera Features

Camera Front

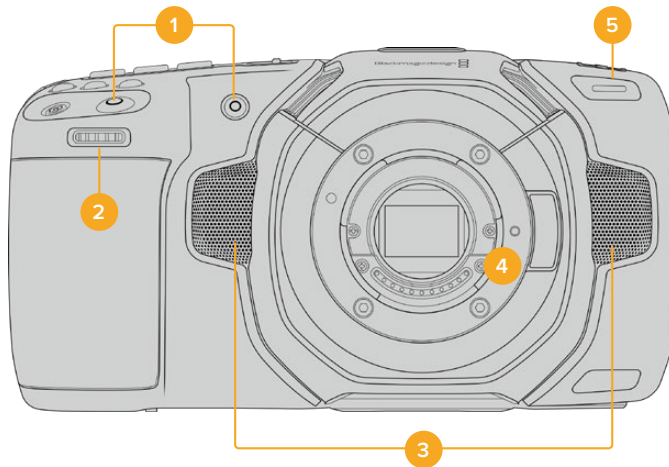

1 Record Buttons

Press either of the record buttons to start and stop recording. A record button is located on the front of the camera to let you start and stop recording more easily if you are recording yourself.

2 Settings Wheel

The settings wheel lets you adjust the aperture of compatible lenses mounted to your camera. With the touchscreen facing you, rotate the wheel left to open the iris, and right to close. The settings wheel is also used to adjust white balance, shutter angle and ISO settings. Press the corresponding buttons on the top of the camera, then make your selection by rotating the settings wheel. After making your selection, press the settings wheel to quickly dismiss the selection menu.

3 Stereo Microphones

There are four built in, high quality stereo microphones. Refer to the 'audio settings' section for information on microphone audio settings.

4 Lens Mount

Blackmagic Pocket Cinema Camera 6K has an active EF lens mount and the 4K model has an active Micro Four Thirds lens mount. This means that you can use lenses with built-in stabilization on both cameras, as well as use auto focus and auto exposure with compatible lenses. To use the image stabilizer or 'IS' feature found in many active lenses, set the stabilizer switch to 'on' to enable image stabilization on your camera. If your lens also features a stabilizer mode switch, set it to the appropriate mode for still shots or for movement. If your lens does not have a physical stabilizer switch, you can turn 'image stabilization' on or off in your camera's setup menu.

5 Tally / Record Indicator

Your camera has a small LED on the front of the camera that illuminates red to indicate that the camera is recording. You can enable or disable the tally light indicator, and adjust its brightness in the setup menu. See the 'setup settings' section for more information.

Right Side

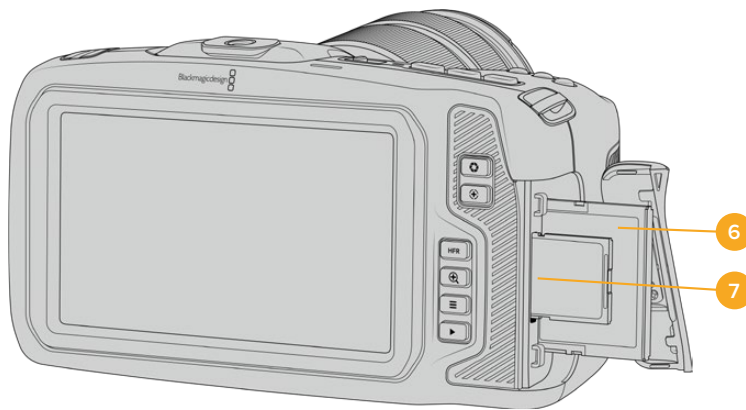

6 CFast Card Slot

Insert CFast 2.0 cards into the slot for record and playback. Refer to the 'CFast Cards' section for more information.

7 SD Card Slot

Insert SD cards into the slot for record and playback. Refer to the 'SD Cards' section for more information.

Left Side

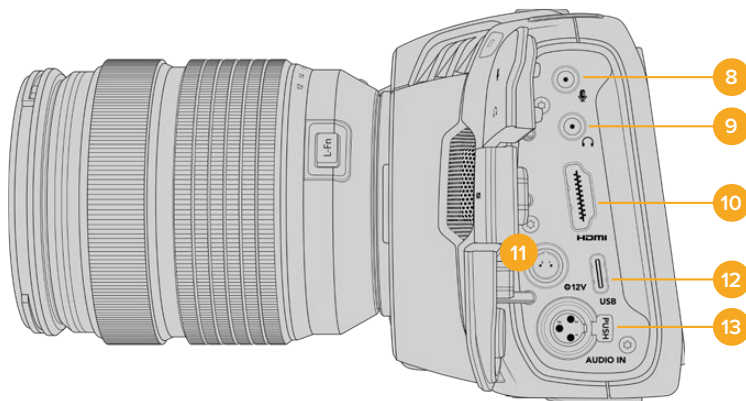

8 3.5mm Microphone Input

Connect a microphone to your camera's 3.5mm stereo connector. Mic and line level audio are supported. The microphone level audio is lower than the line level, so if you are connecting a microphone to the camera and have line level selected, you will find

the levels are too low. The microphone input also accepts SMPTE compliant LTC timecode from an external source on the left channel. Valid timecode will be detected automatically, and embedded in your video file as timecode metadata. We recommend sending LTC timecode via a line level output, especially if you are not recording timecode as an audio track.

9 Headphones Input

Monitor audio while recording or playing back clips by plugging your headphones into the 3.5mm stereo headphones jack. When headphones are plugged in, the speaker output is muted.

10 HDMI Out

The full size HDMI connector supports 10-bit 4:2:2 1080p HD video with support for HDR and two channels of embedded audio. Use the touchscreen menu to set a clean feed or include overlays on the output.

11 Power Input

You can use the DC jack to power your camera and trickle charge the battery at the same time. To connect the power adapter, rotate the plug so it aligns with the recess at the top of the jack, then push in the plug until it locks. To disconnect the power plug, retract the locking sheath, then pull out the plug.

Custom Power Solutions

Some customers have been creating custom made power devices as a means to power their Blackmagic Pocket Cinema Camera. If you are creating your own power solution with a dummy battery, caution needs to be taken to make sure you are not supplying too much voltage to your camera, as this can cause permanent damage. The voltage requirements of the Pocket Cinema Camera are as follows:

- The battery input connection is rated from 6.2V to 10V max.
- The DC input is rated from 10.8V to 20V max.
- The camera requires 16W when in standby and is not charging the battery.
- The camera requires 30W when charging the LP-E6 type battery.
- When powering your camera with a custom made power source, we recommend removing the LP-E6 type battery.
- When recording to external media with an active lens, full screen brightness, full tally brightness, high frame rates and not charging the battery, Pocket Cinema Camera 6K requires 25W and Pocket Cinema Camera 4K requires 22W.

12 USB

The USB-C port lets you record directly to an attached USB-C flash disk. When your camera is switched off, you can recharge its battery via the USB-C port from an external source such as a battery pack. To update your camera's internal software, connect the camera to a computer via the USB-C port and run the camera update application.

13 Mini XLR Microphone Input

Plug in external balanced analog audio via the mini XLR connector. A standard XLR microphone can be connected to your camera using an XLR to mini XLR adapter cable.

The mini XLR input provides phantom power for connecting professional microphones that aren't internally powered. For more information on enabling phantom power refer to the 'audio' section in this manual.

Top Panel

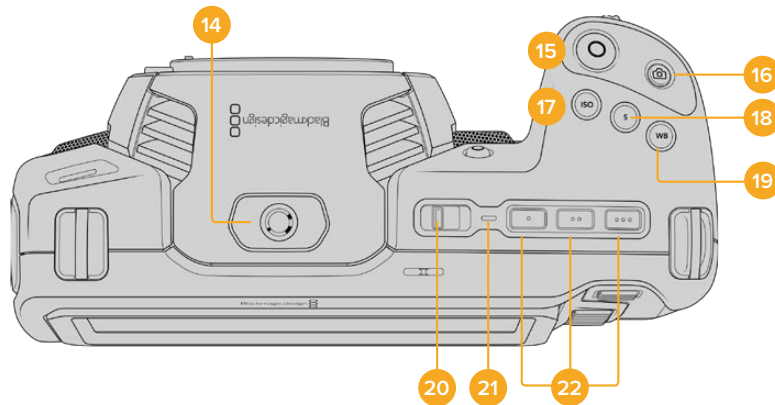

14 1/4-20 Mounting Point

You can use the 1/4-20 mounting point on the top of your camera to attach an external microphone or other small accessories.

NOTE The 1/4" mount on the top of the Pocket Cinema Camera should only be used for lightweight accessories such as small microphones. Do not support the weight of the camera via the top 1/4" mount by using accessories like a screw in camera handle in conjunction with a heavy lens. This will damage the 1/4" mount which will not be covered under warranty. Do not subject the mount to excessive lever force, such as mounting a heavy accessory on an extension arm. To mount heavier accessories, we strongly recommend using a camera cage designed for the Pocket Cinema Camera that attaches to both the top and bottom 1/4" mount simultaneously.

15 Record

Press the record button to begin recording immediately. Press again to stop recording.

16 Still

To capture a single uncompressed DNG frame, press the 'still' button. A camera icon appears briefly in the top right corner of the touchscreen display to let you know you have successfully captured a still. Image files are saved to the 'stills' folder in the root directory of the media you are currently recording to. These follow the file naming convention for video clips but the filename has 'S001' representing the 'still number' as the last four characters of the filename.

17 ISO

Press the ISO button and then rotate the settings wheel to adjust your camera's ISO setting. ISO can be set at 1/3 stop increments between 100 and 25,600.

18 Shutter

To change the shutter angle or shutter speed, press the shutter button, then rotate the settings wheel. The touchscreen display will also suggest up to three flicker free shutter options.

19 White Balance

Press the white balance button and then rotate the settings wheel to adjust your camera's white balance. You can also quickly enter the 'auto white balance' screen by holding the 'wb' button for 3 seconds. Your camera will overlay a white square in the center of your image, and use this area to perform an auto white balance. For more information refer to the 'touchscreen controls' section.

20 Power Switch

Power switch for turning on the camera. Slide the switch to the right to power on your camera, and to the left to power off.

21 Status LED

When the camera is turned off and plugged into external power via the 12V DC power jack or USB-C port, the indicator illuminates red to indicate the battery is being charged.

The status LED turns off when the battery is fully charged.

22 Function Buttons

These buttons can be programmed to a variety of commonly used functions using your camera's 'setup' menu. By default, button one is set to 'false color', button 2 is set to 'display LUT' and button 3 is set to 'frame guides'.

Camera Underside

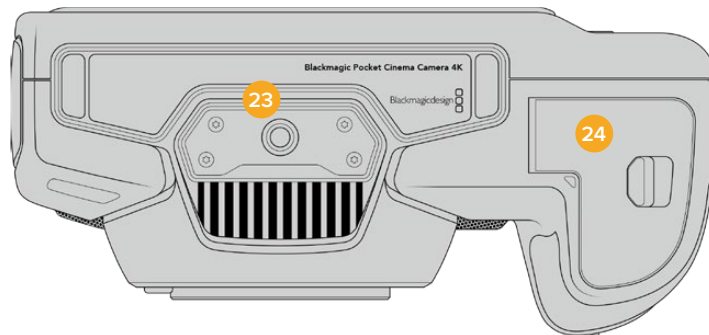

23 1/4-20 Mounting Point

Attach your camera to a tripod using the bottom 1/4-20 mounting point.

24 Battery Door

Push the battery door release towards the lens mount to open the battery door. To close, simply push the door in until it clicks shut.

Camera Rear

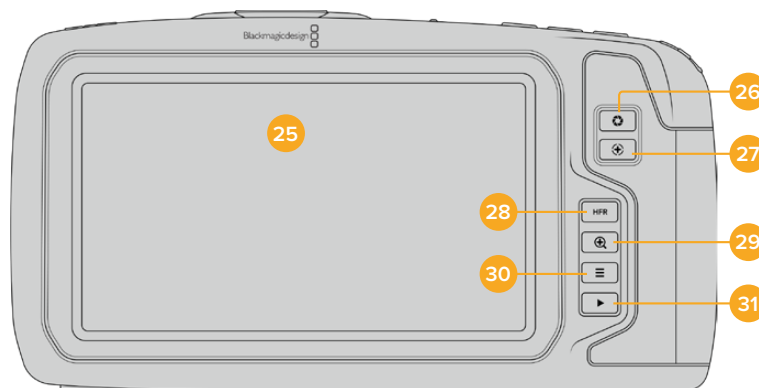

25 Touchscreen Display

Monitor your clips during recording and playback using the touchscreen display. Tap and swipe to adjust settings and control your camera.

26 Iris Button

Pressing the 'iris' button automatically sets an average exposure based on the highlights and shadows in your shot. You can adjust your lens aperture manually by rotating the settings wheel to the left and right, or by tapping 'iris' on the touchscreen display and adjusting the iris slider.

27 Focus Button

When using a compatible auto focus lens with your camera, press the 'focus' button once to auto focus. By default the lens will auto focus in the center of the image, however you can select an alternate auto focus point by tapping on the LCD screen in the area that you want to focus. Double press the focus button to reset the focus point to the center of the screen.

NOTE It's important to know that while most lenses support electronic focus, some lenses can be set to manual or auto focus modes. In this case you need to confirm your lens is set to auto focus mode.

28 HFR Button

Press the HFR or 'high frame rate' button to toggle off speed frame rates. To use this function, simply set the 'off speed' frame rate you'd like to use in the 'frame rate' menu. Once this is set, pressing the HFR button will toggle between your chosen off speed frame rate and project frame rate. It's worth mentioning that this setting can only be adjusted when the recording is stopped.

For more information on project and off speed frame rates, see the 'touchscreen controls' section.

29 Focus Zoom Button

Press the 'focus zoom' button to zoom in for adjusting focus at the 1:1 pixel scale. Whilst zoomed in, you can touch and drag on the screen to view different areas of the image.

To zoom out, press the 'focus zoom' button again.

30 Menu Button

Press the 'menu' button to open the dashboard.

31 Play Button

Press the play button to switch to playback mode. Press the button again for instant playback of the last recorded clip on the LCD, and on any display connected to the HDMI output.

Touchscreen Controls

Touchscreen Features

Your Blackmagic Pocket Cinema Camera's LCD touchscreen features a touch and gesture based interface that is specifically designed for fast and intuitive operation. By touching and swiping on different areas of the LCD touchscreen, you can quickly access the camera's functions while shooting.



Your Blackmagic camera's LCD touchscreen display gives you easy access to your camera's most used settings

LCD Monitor Options

Tap the 'monitor' icon at the top left of the touchscreen to access the LCD monitor settings. These settings let you toggle and adjust the appearance of your Pocket camera's monitoring features, including zebra, focus assist, frame guides, grids, safe area guides and false color. When accessing LCD monitor options, the controls for these features appear in a tabbed menu along the bottom edge of the LCD touchscreen.

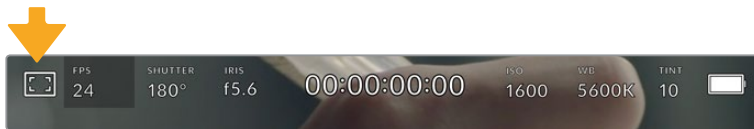

Tap the icon at the top left of your camera's LCD touchscreen to access LCD monitor options

Zebra

The 'zebra' setting toggles the appearance of zebra on the LCD touchscreen, as well as setting the zebra level for the HDMI output.

Zebra displays diagonal lines over areas of your image that exceed a set exposure level. For example, setting zebra to 100% shows which areas are completely overexposed. This is useful for achieving optimum exposure in fixed lighting conditions.

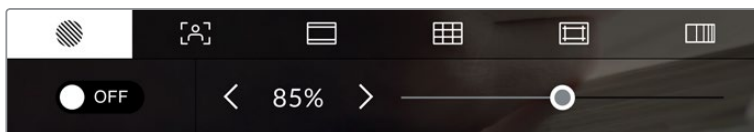

Tap the 'zebra' icon while accessing 'LCD monitor options' to access the zebra settings

To toggle zebra for the LCD touchscreen, tap the switch icon in the bottom left of the screen while in the 'zebra' tab.

Set the exposure level that zebra appears at by dragging the slider left and right, or tapping the arrow buttons next to the zebra level percentage. Zebra level is adjustable in five percent steps between 75 and 100 percent exposure.

For information on enabling zebra on your camera's HDMI output, see the 'monitor settings' section in this manual.

TIP If you're shooting in variable light such as outdoors on a partly overcast day, setting your zebra level lower than 100 can warn you of potential overexposure.

Focus Assist

The 'focus assist' setting toggles the appearance of focus assist on the LCD touchscreen, as well as setting the level of focus assistance for the HDMI output on your Blackmagic Pocket Cinema Camera.

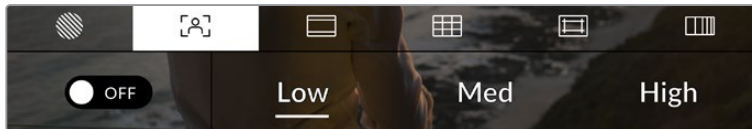

Tap the 'focus assist' icon while accessing 'LCD monitor options' to access your camera's focus assist settings

To toggle focus assistance for the LCD touchscreen, tap the switch icon in the bottom left of the screen while in the 'focus assist' tab.

To set the level of focus assistance for the HDMI output on your camera, tap the 'low,' 'medium' or 'high' titles along the bottom of the touchscreen.

The optimum level of focus assistance varies shot by shot. When focusing on actors, for example, a higher level of focus assistance can help resolve edge detail in faces. A shot of foliage or brickwork, on the other hand, may show distracting amounts of focus information at higher settings.

For information on enabling focus assist on your camera's HDMI output, see the 'monitor settings' section in this manual.

TIP Your Blackmagic Pocket Cinema Camera has two focus assist modes. You can switch between 'peaking' and 'colored lines' focus assistance in the 'monitor' settings menu. For more information, see the 'monitor settings' section in this manual.

Frame Guides

The 'frame guide' setting toggles the appearance of frame guides on the LCD touchscreen. You can also choose from eight frame guide options for your camera's HDMI output.

Frame guides include aspect ratios for various cinema, television and online standards.

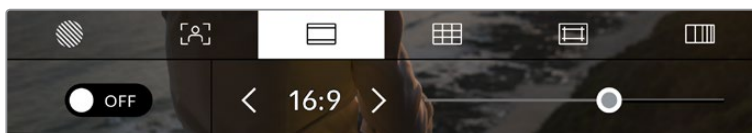

Tap the 'frame guides' icon while accessing 'LCD monitor options' to access your frame guide settings

To toggle the appearance of frame guides on the LCD touchscreen, tap the switch icon in the bottom left of the screen.

Choose the frame guide you want to use by dragging the slider left and right, or tapping the arrow buttons on either side of the currently selected aspect ratio.

The available guides are:

- **2.35:1, 2.39:1 and 2.40:1**

Displays the broad widescreen aspect ratio compatible with anamorphic or flat widescreen cinema presentation. The three widescreen settings differ slightly based on the changing cinema standards over time. 2.39:1 is one of the most prominent standards in use today.

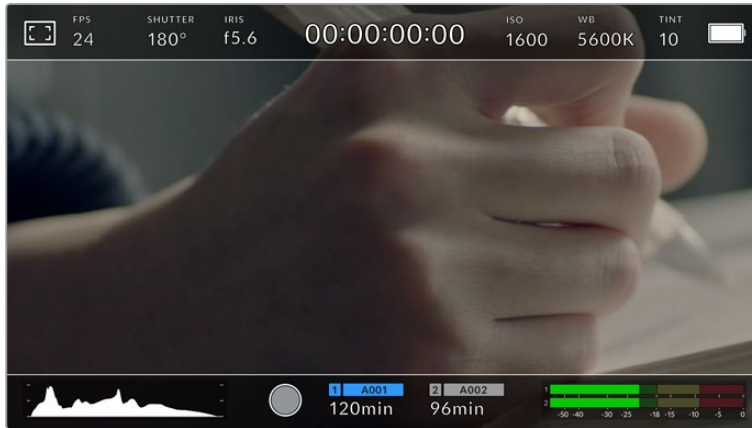

The LCD touchscreen with 2.40:1 frame guides enabled

- **2:1**

Displays a ratio slightly wider than 16:9 but not as wide as 2.35:1.

- **1.85:1**

Displays another common flat widescreen cinema aspect ratio. This ratio is slightly wider than HDTV 1.78:1 but not as wide as 2.39:1.

- **16:9**

Displays a 1.78:1 aspect ratio compatible with 16:9 HD television and computer screens. This ratio is most commonly used for HD broadcasting and online videos. The same aspect ratio has also been adopted for Ultra HD broadcasting.

- **14:9**

Displays a 14:9 aspect ratio used by some television broadcasters as a compromise between 16:9 and 4:3 television sets. Ideally, both 16:9 and 4:3 footage remains legible when center cropped to fit 14:9. You can use this as a compositional guide if you know your project may be broadcast by a television station that uses 14:9 cropping.

- **4:3**

Displays the 4:3 aspect ratio compatible with SD television screens, or to help with framing when using 2x anamorphic adapters.

TIP You can change the opacity of frame guide overlays. For more information see the 'monitor settings' section of this manual.

NOTE For information on enabling frame guides on your camera's HDMI output, see the 'monitor settings' section in this manual.

Grids

The 'grids' setting toggles the appearance of a rule of thirds grid, crosshair or center dot on the LCD touchscreen, as well as setting the overlay that will be visible on the HDMI output.

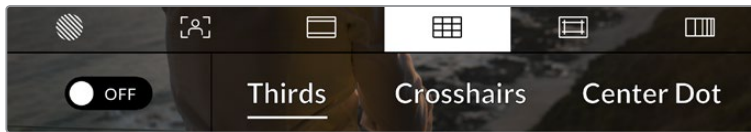

Tap the 'grids' icon while accessing 'LCD monitor options' to access the grid settings

Grids and crosshairs are overlays that can help with image composition. When 'grids' are enabled, the LCD shows a rule of thirds grid, crosshairs, or center dot.

To toggle the appearance of grids on your camera's touchscreen, tap the switch icon in the bottom left of the screen while in the 'frame guides' tab.

To set which overlay you want to display on the HDMI output, tap the 'thirds,' 'crosshairs,' or 'center dot' options.



The rule of thirds grid automatically scales to any on screen frame guides

• Thirds

The 'thirds' setting displays a grid with two vertical and horizontal lines placed in each third of the image. Thirds are an extremely powerful tool to help compose your shots. For example, the human eye typically looks for action near the points where the lines intersect, so it's helpful to frame key points of interest in these zones. An actor's eyeline is commonly framed along the top third of the screen, so you can use the top horizontal third to guide your framing. Thirds are also useful to maintain framing consistency between shots.

• Crosshairs

The 'crosshair' setting places a crosshair in the center of the frame. Like thirds, the crosshair is a very useful compositional tool, making it easy to frame the subject of a shot in the very center of a frame. This is sometimes used when filming scenes that will be assembled using very fast cuts. Keeping viewers' eyes focused on the center of a frame can make rapid editing easier to follow.

• Center Dot

The 'center dot' setting places a dot in the center of the frame. This works in exactly the same way as the 'crosshair' setting, albeit with a smaller overlay that you may find less intrusive.

You can enable a combination of 'thirds' and 'crosshairs' or 'thirds' and 'center dot' by tapping both options in the 'grids' menu. 'Crosshairs' and 'center dot' cannot be selected together.

TIP For information on enabling grids on your HDMI output, see the 'monitor settings' section in this manual.

Safe Area Guides

The 'safe area guides' setting toggles the safe area guides on or off the LCD touchscreen, as well as setting the size of safe area guides for the HDMI output.

Safe areas can be used in broadcast production so the most important parts of a shot can be seen by viewers. By keeping the most important parts of your shot inside a central 'safe area,' you can avoid cropping on some televisions, as well as leaving space for a broadcaster to add bugs, news tickers and other overlays along the edges of the screen. Many broadcasters require footage to be submitted with important content, such as titles and graphics, contained inside the 90% safe area.

Safe area guides can also be used to assist with framing your shot where you know that the shot will be stabilised in post production, which can crop the edges of the image. They can also be used to indicate a specific crop. For example by setting it to 50% when recording at Ultra HD 3840x2160 you can see what a 1920x1080 crop of the frame would look like. The safe area guides also scale to your frame guides, so they will adjust to indicate the chosen percentage of your target frame.

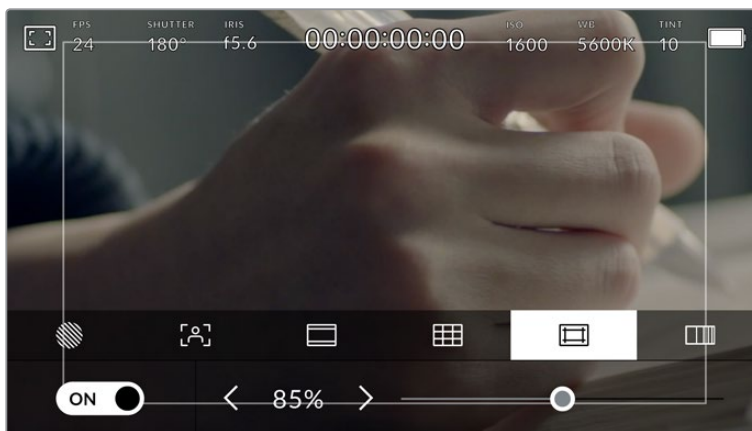

The 'safe area' indicator set to 85%

To toggle safe area guides for the LCD touchscreen, tap the switch icon in the bottom left of the screen while in the 'safe area guides' tab. To set the level of safe area guides for your camera's HDMI output, tap the left or right arrows on either side of the current numerical value at the bottom of the touchscreen. Alternatively, you can drag the slider left or right.

False Color

The 'false color' setting toggles the appearance of false color exposure assistance on the LCD touchscreen.

False color overlays different colors onto your image that represent exposure values for different elements in your image. For example, pink represents optimum exposure for caucasian skin tones, while green is a good match to darker skin tones. By monitoring the pink or green false color when recording people, you can maintain consistent exposure for their skin tones.

Similarly, when elements in your image change from yellow to red, that means they are now over exposed.

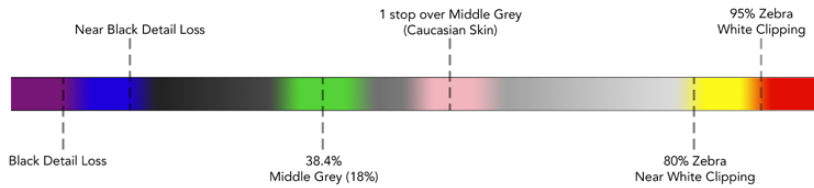

False Color Chart

To toggle false color for the LCD touchscreen, tap the switch icon in the bottom left of the screen while in the 'false color' tab.

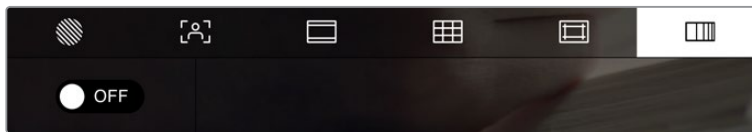

The 'false color' exposure assistance tab

Frames Per Second

The 'FPS' indicator displays your currently selected frames per second.

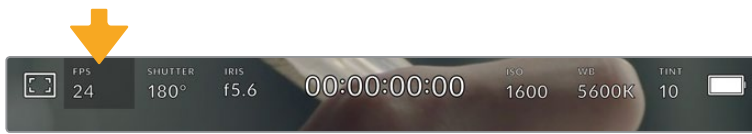

Tap the frames per second indicator to access frame rate settings

Tapping the 'FPS' indicator lets you change your camera's sensor and project frame rates via a menu at the bottom of the LCD touchscreen.

Project Frame Rate

The project frame rate is the camera's recording format frame rate and provides a selection of common frame rates used in the film and television industry. This frame rate is normally set to match your post production workflow.

8 project frame rates are available including 23.98, 24, 25, 29.97, 30, 50, 59.94 and 60 frames per second.

To adjust your camera's project frame rate while in the 'FPS' menu, tap the left or right arrows next to the current frame rate at the bottom left of your touchscreen. Alternatively, you can drag the slider left or right.

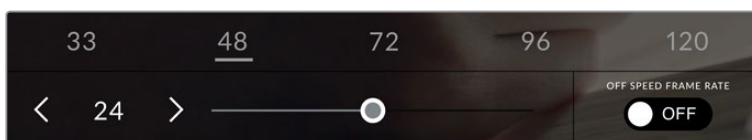

Tap the arrows on either side of the project frame rate or move the slider to make adjustments

TIP Your Blackmagic Pocket Cinema Camera's project frame rate also sets the frame rate of the HDMI output.

Sensor Frame Rate

The sensor frame rate sets how many actual frames from the sensor are recorded every second. This frame rate will affect how fast or slow your video will play back at your set project frame rate.

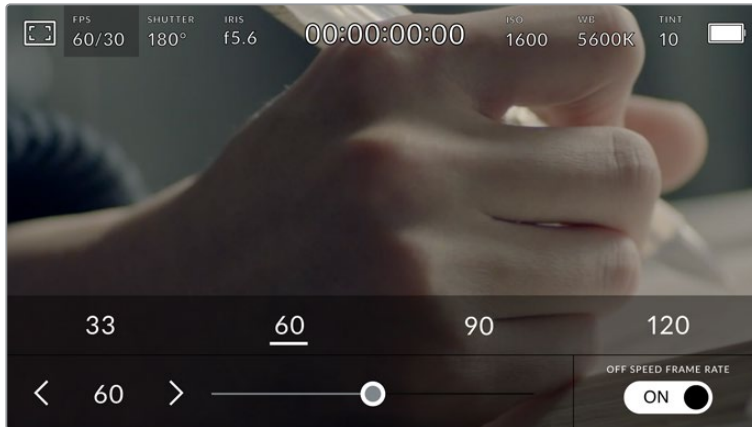

With 'off speed frame rate' enabled, tap a preset or the arrows on either side of the sensor frame rate or move the slider to make adjustments

By default, the project and sensor frame rates are matched for a natural playback speed. However, by tapping the 'off speed frame rate' switch icon in the bottom right hand side of your camera's 'FPS' menu, you can independently set the sensor frame rate.

To change the sensor frame rate, tap the arrows next to the sensor frame rate indicator in the lower left of your touchscreen. You can also drag the slider left or right to increase or decrease the frame rate. Once you release the slider, the sensor frame rate will be selected.

You can create dynamic and interesting speed effects in your clips by varying the sensor frame rate. Setting the sensor frame rate higher than your project frame rate will create slow motion during playback. For example, shooting with a 60 FPS sensor frame rate and playing back at a 24 FPS project frame rate creates slow motion at 40% of the real speed of the action.

Alternatively, the lower your sensor frame rate, the faster your clips will appear. The principle is similar to overcranking and undercranking a film camera. Overcranking speeds up the sensor frame rate so you can stretch out moments in time during playback to enhance emotion. Undercranking slows down the sensor frame rate so you can increase the speed of action in fast moving scenes. The creative possibilities are endless and entirely up to you!

For information on the maximum frame rates available for each recording format and codec, refer to the table in the 'recording' section of this manual.

NOTE When 'off speed frame rate' is selected the audio and video are no longer synced. This is true even if you set the same project and sensor frame rate. For this reason, avoid selecting 'off speed frame rate' if you want to guarantee audio syncing.

Shutter

The 'shutter' indicator displays your shutter angle or shutter speed. By tapping this indicator, you can manually change your camera's shutter values or configure shutter priority auto exposure modes. The shutter measurement setting can be used to select whether to display shutter information as 'shutter angle' or 'shutter speed'. See the 'setup settings' section in this manual for more information.

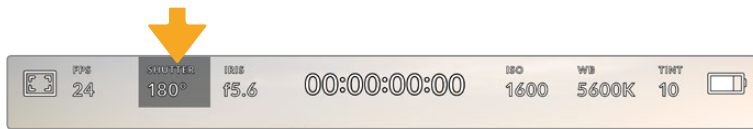

Tap the shutter indicator to access shutter settings

Shutter angle or shutter speed defines the level of motion blur in your video, and can be used to compensate for varying light conditions. 180 degrees is the optimum shutter angle for capturing satisfying motion blur in most conditions, with the equivalent being a shutter speed of 1/50th of a second. However as lighting conditions change, or the amount of movement in your scene increases, you may decide to adjust accordingly.

For example, 360 degrees is considered 'wide open' and allows maximum light onto the sensor. This is useful for low light conditions with subtle movement in your scene. Alternatively, if shooting subjects with a lot of movement, a narrow shutter angle like 90 degrees will provide minimal motion blur for sharper, crisper images. The equivalent shutter speeds compared to shutter angle depends on the frame rate you are using.

For example, if you are shooting at 25 frames per second, then 360 degrees will equate to 1/25th, and 90 degrees will equate to 1/100th of a second.

NOTE When shooting under lights, your shutter can affect the visibility of flicker. Your Blackmagic Pocket Cinema Camera will automatically calculate a flicker free shutter value for your current frame rate. It will display up to three suggested flicker free shutter options at the bottom of the touchscreen display when adjusting your shutter. These shutter values are affected by mains power frequency in your region. You can set your local power frequency to 50Hz or 60Hz in the camera's setup menu. See the 'setup settings' section in this manual for more information.

Tapping the 'shutter' indicator brings up the suggested shutter values along the bottom of the touch screen. If you have auto exposure set to 'off,' this screen will show you your currently selected shutter value, as well as the available flicker free shutter values, based on the mains power frequency you have selected in your camera's setup menu. For more information, see the 'setup settings' section in this manual.

NOTE The characteristics of individual light sources may still cause flicker even when using flicker free values. We recommend always performing a test shoot when not using continuous lights.

To select one of the flicker free shutter values, simply tap on one of the displayed shutter values. Using the arrows on either side of the current shutter value indicator, will cycle through some of the most commonly used values.



Your camera will suggest flicker free shutter values based on the mains power frequency you choose in the 'setup' menu

If you are shooting outside, or using flicker free lights, you can also manually select a shutter value by double tapping the current shutter indicator at the bottom left of your screen. When shutter angle is selected, this will bring up a keypad which you can use to set any shutter angle between 5 and 360 degrees.



Use the manual shutter keypad to enter your shutter timing of choice when shooting outdoors or under flicker free lights

Your Blackmagic Pocket Cinema Camera has three shutter based auto exposure modes. To select one of these, tap the 'auto exposure' button in the far right of the shutter menu.

Shutter

This setting automatically adjusts shutter value to maintain a constant exposure while keeping iris aperture consistent. If you want to maintain a fixed depth of field, this is the setting to choose. It's worth mentioning that the subtle automatic adjustments of the shutter may have an effect on motion blur. It's also worth keeping an eye out for any flicker that may be introduced from various light fixtures on indoor shoots. The auto iris feature is not available when the 'shutter' auto exposure mode is selected.

Shutter + Iris

Maintains the correct exposure levels by adjusting the shutter, then the aperture. If the maximum or minimum available shutter value is reached and exposure still cannot be maintained, your camera adjusts the aperture to keep exposure consistent.

Iris + Shutter

Maintains the correct exposure levels by adjusting the aperture, then the shutter value. If the maximum or minimum available aperture is reached and exposure still cannot be maintained, your camera adjusts the shutter value to keep exposure consistent.

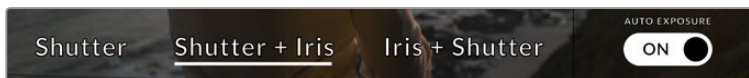

While in the shutter menu, tap 'auto exposure' to access shutter based auto exposure modes

TIP When an auto exposure mode that effects the shutter or iris is enabled, a small 'A' appears next to the shutter or iris indicator at the top of the LCD touchscreen.

Iris

The 'Iris' indicator displays your current lens aperture. By tapping this indicator, you can change the aperture of compatible lenses and configure iris based auto exposure modes.

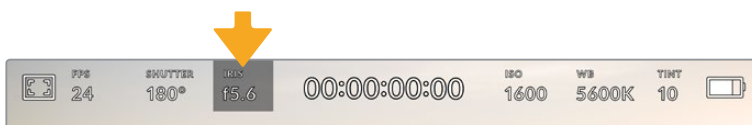

Tap the iris indicator to access iris settings

NOTE To adjust your Iris from the LCD touchscreen, your Blackmagic Pocket Cinema Camera must be fitted with a lens that supports changing aperture via the camera.

Tapping the 'iris' indicator once brings up the iris menu along the bottom of the touchscreen. You'll see your current lens aperture at the far left of this menu. You can change the aperture by tapping the left and right arrows on either side of the current aperture, or moving the slider left or right.

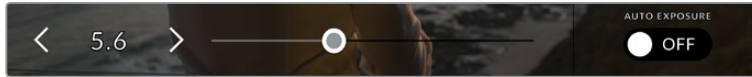

While in the 'iris' menu, tap the arrows on either side of the iris indicator or use the slider to adjust iris settings

Tapping the 'auto exposure' switch icon at the far right of the iris menu opens the iris auto exposure menu.

This gives you the following auto exposure options.

Iris

This setting automatically adjusts the aperture to maintain a constant exposure while keeping shutter angle consistent. This will keep motion blur unaffected, but may affect your depth of field.

Iris + Shutter

Maintains the correct exposure levels by adjusting the aperture, then the shutter value. If the maximum or minimum available aperture is reached and exposure still cannot be maintained, your camera adjusts the shutter value to keep exposure consistent.

Shutter + Iris

Maintains the correct exposure levels by adjusting the shutter, then the aperture. If the maximum or minimum available shutter value is reached and exposure still cannot be maintained, your camera adjusts the aperture to keep exposure consistent.

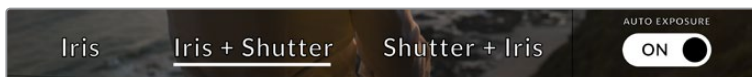

While in the iris menu, tap 'auto exposure' to access iris based auto exposure modes

TIP When an auto exposure mode that effects the iris or shutter is enabled, a small 'A' appears next to the iris or shutter indicator at the top of the LCD touchscreen.

Duration Display

At the top of your camera's LCD touchscreen, you'll see your camera's duration display.



Your camera's duration display will turn red while recording.

The duration display provides a timecode counter for checking the duration of your clips and monitoring timecode during recording and playback. The counter displays a time sequence showing Hours:Minutes:Seconds:Frames and will change accordingly as you record or play back clips. During recording the timecode is red.

The displayed duration starts from 00:00:00:00. The clip duration of the current or last recorded clip is displayed on the touchscreen. Time of day timecode is embedded into clips for easier post production.

To see the timecode, simply tap the duration display. Tap the duration display again to return to clip duration.

Additional status indicators may appear around the duration display:



Appears to the left of the duration display when your Blackmagic Pocket Cinema Camera is using a windowed sensor mode.



Appears to the right of the duration display when showing timecode.



Appears to the right of the duration display if an external LTC timecode is connected to the 3.5mm stereo input jack and valid.



Appears to the right of the duration display if the camera is running off an internal timecode after being 'jam synced' and disconnected.

ISO

The 'ISO' indicator displays the current ISO setting, or light sensitivity. Tapping this indicator lets you adjust your ISO to suit varying lighting conditions.

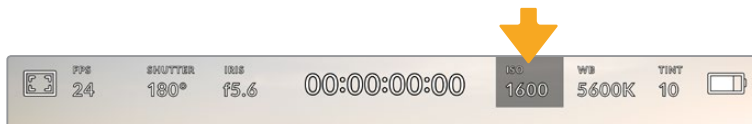

Tap the ISO indicator to access ISO settings.

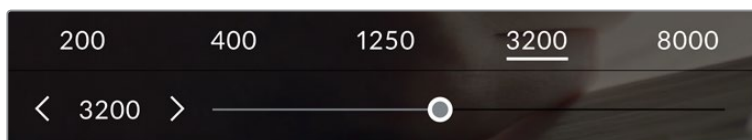

While in the 'ISO' menu, your camera's ISO settings appear along the bottom of the LCD touchscreen. The slider below the presets lets you adjust ISO in 1/3 stop increments.

Depending on your situation, you may choose a lower or higher ISO setting. For example, in low light conditions ISO 25,600 can be suitable but may introduce some visible noise. In bright conditions ISO 100 can provide richer colors.

Dual Native ISO

Your Blackmagic Pocket Cinema Camera has a dual native ISO of 400 and 3,200, which means that the sensor is optimized for shooting in both low light conditions, as well as bright daylight.

Adjust the ISO for the varying lighting conditions, and the dual native ISO feature will operate in the background to make sure your footage is clean and has minimal noise at low and high ISO settings.

When the ISO setting is between 100 and 1,000 the native ISO of 400 is used as a reference point. The ISO range between 1,250 and 25,600 uses the native ISO of 3,200 as a reference. If you are shooting in conditions where you have a choice between ISO 1,000 or 1,250, we suggest closing down one stop on your lens' iris so that you can select ISO 1,250 as it will engage the higher native ISO and provide much cleaner results.

These charts show the relationship between the ISO selection and dynamic range allocation.

Blackmagic Pocket Cinema Camera 6K Dynamic Range

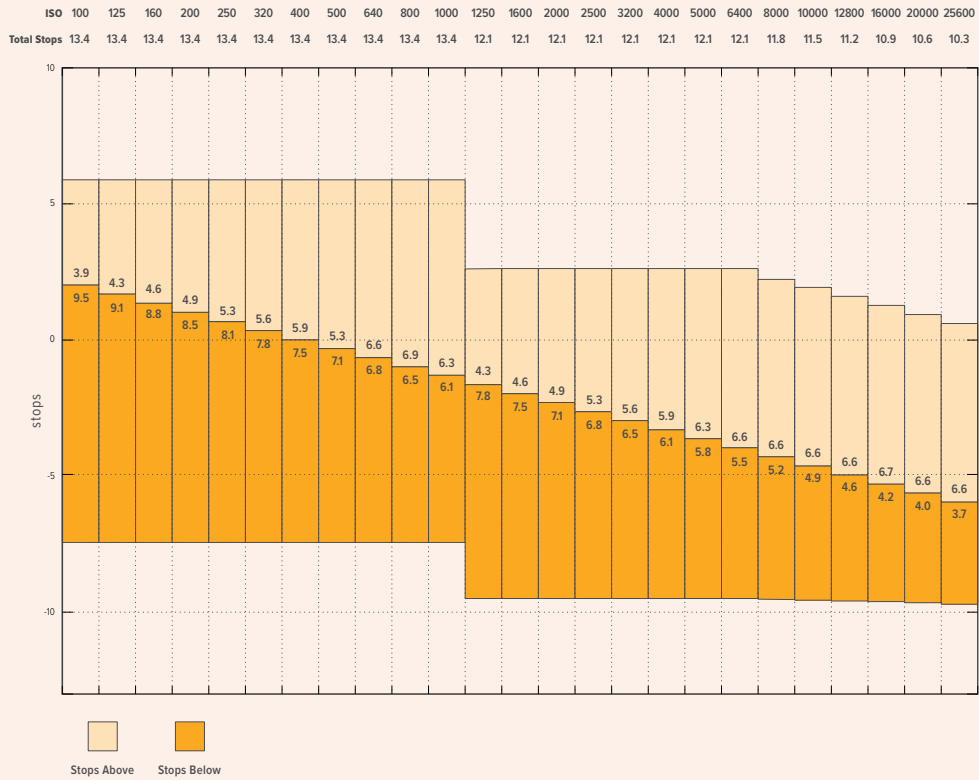

Blackmagic Pocket Cinema Camera 4K Dynamic Range

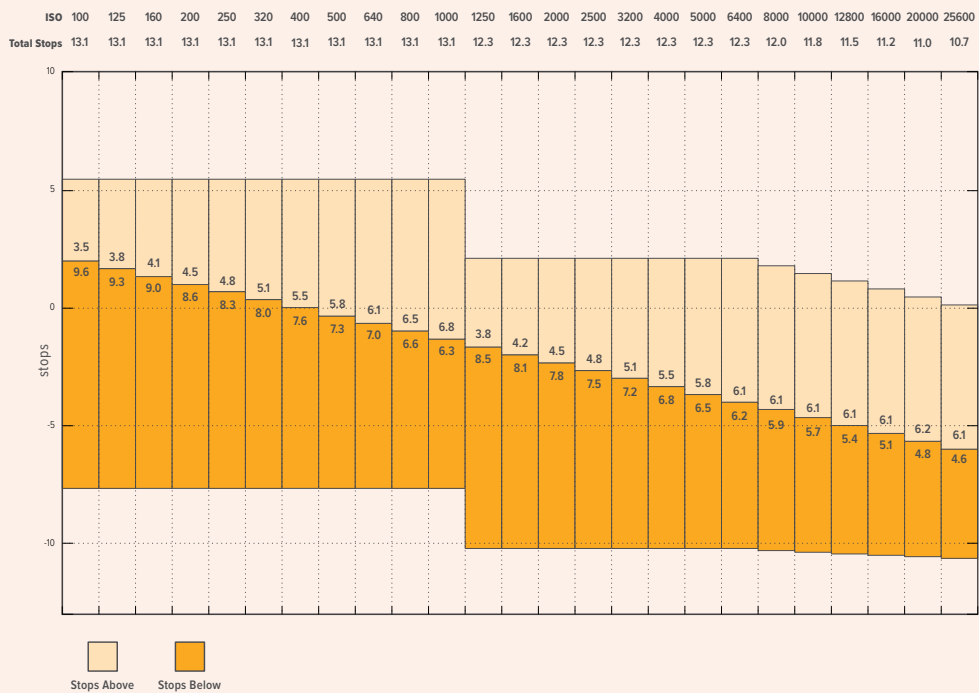

White Balance



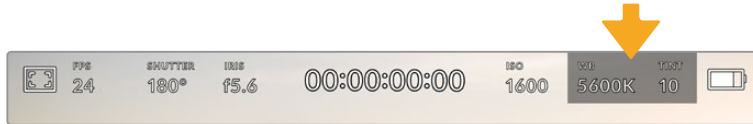

The 'WB' and 'TINT' indicators display your camera's current white balance and tint. Tapping these indicators lets you adjust your camera's white balance and tint to suit varying lighting conditions.



Tap the white balance and tint indicators to access white balance and tint settings

Every light source emits a color. For example, a candle flame emits a warm color, and an overcast sky emits a cool color. White balance settings are used to color balance your image so white stays white by adjusting the mix of orange and blue in your image. For example, when shooting under tungsten lamps which emit a warm, orange light, selecting 3200K adds some blue to the image. This balances the color so white is accurately recorded.

Your Blackmagic Pocket Cinema Camera comes with white balance presets for a variety of color temperature conditions. These are:

| | | |
|---|---------------------------|---------|
|  | Bright sunlight | (5600K) |
|  | Incandescent bulbs | (3200K) |
|  | Fluorescent bulbs | (4000K) |
|  | Mixed light | (4500K) |
|  | Cloud | (6500K) |

You can customize any of these presets by tapping or holding the arrow icons to the left and right of the temperature indicator in the bottom left of the 'white balance' menu. Each tap moves the color temperature up or down 50K, but holding the arrow icons down will increase the speed. Alternatively, you can move the temperature slider in the middle of the 'white balance' menu.

To further dial in your image, you can adjust the 'tint.' This adjusts the mix of green and magenta in your image. For example, adding some magenta can compensate for the green cast of many fluorescent lights. Many of your camera's white balance presets include some tint.



Tapping the white balance and tint indicator gives you access to five presets, as well as a white balance indicator and slider on the left, and a tint indicator on the right. Adjust these to set a custom white balance for your lighting conditions

While in the 'white balance' menu, your camera's current tint setting is shown at the bottom right of the screen. To adjust the tint, simply tap or hold the arrows to the left and right of the tint indicator. The available range is -50 to +50 in one unit steps. Holding down on the arrows speeds up adjustment.

NOTE Customizing the white balance or tint will change your preset to 'CWB,' or custom white balance. Custom white balances are persistent; your CWB settings will stay configured between power cycles, and when switching to a preset and back to CWB. This makes it easy to compare a custom white balance to the last preset used.

Auto White Balance

Your Blackmagic Pocket Cinema Camera can set white balance automatically. Tapping 'AWB' will bring up the white balance screen.

When setting white balance automatically, a square will be overlaid on the center of your image. Fill this square with a neutral surface such as a white or gray card and tap 'update WB'. The camera will automatically adjust its white balance and tint values so the average of the white or grey inside the white balance square is as neutral as possible. Once updated, this will be set as your camera's custom white balance. Holding the WB button on the top of your camera for three seconds also selects automatic white balance and activates the 'update WB' function.

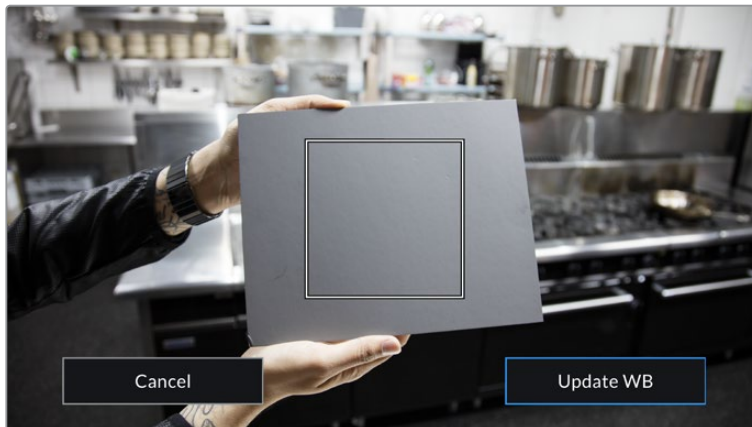



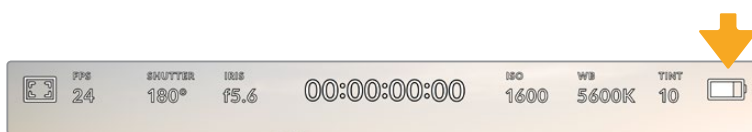

Tapping the 'AWB' icon in the white balance menu will bring up the auto white balance screen. Use this with a white or neutral grey surface to automatically set a neutral white balance

Power

The camera's power source and energy status are displayed in the top right of the LCD screen.



While using battery power, tapping the power indicator toggles between displays

| | | |
|---|----------------------|--|
|  | AC | Displays when your camera is plugged into mains power. |
|  | AC / Charging | Displays when your camera is plugged into mains power, and is simultaneously charging the removable LP-E6 battery. |
|  | Battery bars | The battery included with your camera shows a battery icon that drains in 25% steps. At 20% charge remaining, the battery bar turns red. |
|  | Percentage | If your battery supports percentage display, the battery icon shows the remaining battery level as a percentage, and drains in 1% steps. At 20% charge remaining, the battery bar turns red. |

LUT indicator

When you are using a LUT as a preview tool on set, a LUT icon will be displayed in the top left corner of the screen to indicate that the LUT is currently active.

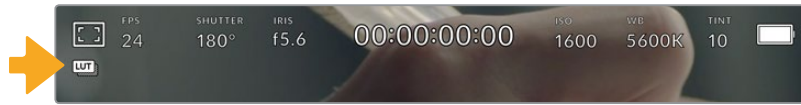

Histogram

At the bottom left of your camera's touchscreen you can see the histogram. The histogram shows the contrast between blacks and whites along a horizontal scale.

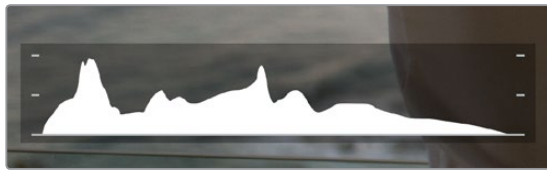

The histogram gives you an indication of the tonal range between shadows and highlights in your clip. It is also a helpful tool for checking the balance of your exposure and to prevent your highlights from clipping.

The left edge of the histogram displays shadows, or blacks, and the far right displays highlights, or whites. When you close or open the lens aperture, you'll notice the information in the histogram moves to the left or right accordingly. You can use this to check 'clipping' in your image shadows and highlights. If the left and right of your edges of the histogram come to an abrupt stop rather than falling off gradually, you may be losing highlight or shadow detail.

NOTE If you don't see a histogram in the bottom left of your touchscreen, your LCD monitor settings may be set to display 'codec and resolution.' See the 'monitor settings' section in this manual for more information.

Record button

Next to the histogram, at the bottom of your Pocket Cinema Camera's touchscreen, is a round grey button. This is the 'record' button. Tap it once to begin recording, and tap it again to stop. While recording, the button, the storage indicator, and the timecode at the top of your Pocket Cinema Camera's touchscreen turn red.

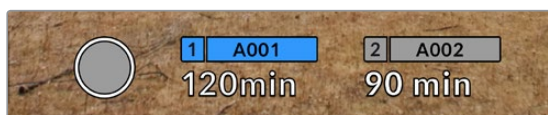

The record button is located next to the storage indicators at the bottom of the LCD touchscreen.



When recording, the record button displays red.

LUT Applied to Clip

If you have chosen to apply a LUT to your recorded clips in the 'record' settings tab, the touchscreen indicates this in standby mode and when recording.

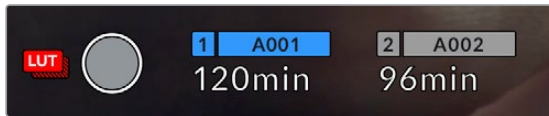

The LUT icon lets you know that recorded clips will have the selected LUT recorded with the clip.



The LUT icon will be displayed when the selected LUT is being recorded with the clip

Dropped Frame Indicator

The 'record' button is overlaid with a flashing '!' indicator if your camera begins dropping frames while recording. The time remaining indicator for the affected card also turns red. For example, if your CFast card is dropping frames, the '!' indicator appears over the 'record' button, and the time remaining indicator on the CFast card turns red. This lets you know if a particular card is too slow for your currently selected codec and resolution. The 'dropped frame indicator' also appears if you have dropped a frame on the previously recorded clip. This indicator continues until another clip is recorded, or the camera is power cycled. Refer to the 'Choosing a CFast 2.0 card' and 'Choosing an SD Card' sections for more information on how to avoid dropping frames.

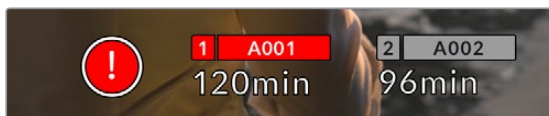

Dropped frame indicator for CFast card dropping frames

NOTE You can set your Blackmagic Pocket Cinema Camera to stop recording if dropped frames are detected to avoid recording unusable footage. See the 'record settings' section in this manual for more information.

Recording Time Remaining

When a CFast or SD card is inserted, or a USB-C flash disk is attached to your camera, the storage indicators at the bottom of the touchscreen show how much recording time is left on the card or USB-C flash disk. The time is shown in minutes and varies according to your selected frame rate and codec. The indicator automatically recalculates if either of these settings are changed. When there is approximately five minutes remaining on your card or drive, the indicator text turns red, then blinks when there is only two minutes remaining. The indicator displays 'full' when a card or drive reaches maximum capacity.

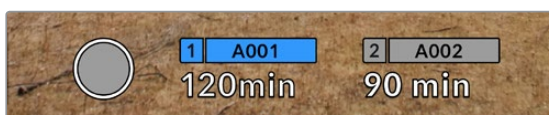

The storage indicator shows the name of your CFast card, SD card or USB-C flash disk and the record time remaining in minutes

The card or drive name is also presented in a small bar above the time remaining. The bar turns blue to indicate the camera is set to record to this card or USB-C flash disk. To record to a different card or drive, press and hold the name of the card or USB-C flash disk you wish to record to. While recording, the bar is red.

Tapping the storage indicators opens the storage and formatting menu.

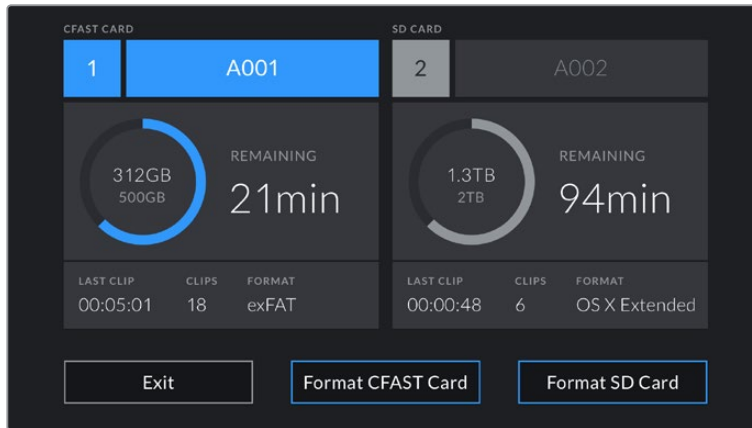

Tap the storage indicators on the LCD touchscreen to access the storage manager

This menu displays the amount of free space on each CFAST card, SD card or USB-C flash disk used by your camera, as well as the name of the card or drive, length of the last clip, total number of clips, and the file format for each card or drive.

You can format your media from this menu. For more information, see the 'preparing media for recording' section of this manual.

TIP Tapping the card or drive name in the storage menu sets it as the active card or drive. Your Blackmagic Pocket Cinema Camera fills this card or drive first.

Audio Meter

The peak audio meters display audio levels for channels 1 and 2 when using the internal microphone, or via external audio when connected. The display is calibrated to dBFS units and features peak hold indicators which stay visible for a short time so you can clearly see the maximum levels reached.

To achieve optimum audio quality, ensure your audio levels do not reach 0 dBFS. This is the maximum level that your camera can record, meaning that any audio that exceeds this level will be clipped, resulting in distortion.



The colored bars on the audio meter represent peak audio levels. Ideally your peak audio levels should fall in the upper end of the green zone. If your peaks enter into the yellow or red zones your audio is in danger of clipping.

You can tap the audio meter to bring up volume controls for audio input channels 1 and 2, as well as headset or speaker volume.

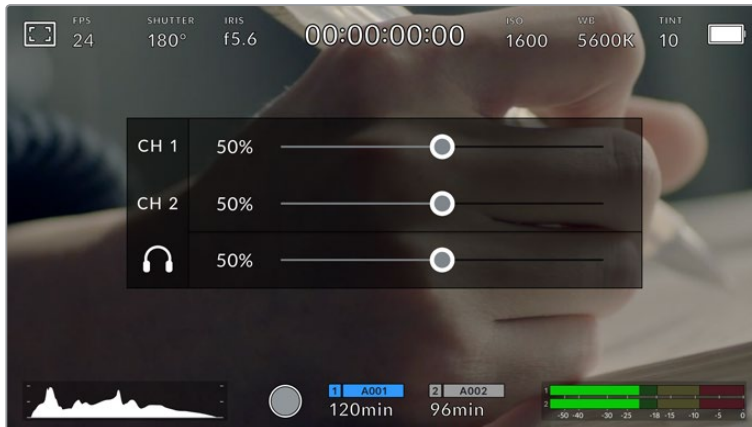

Tap the audio meters on the LCD touchscreen to easily access volume and headset or speaker settings

Double Tap to Zoom

You can magnify any part of your Blackmagic Pocket Cinema Camera's preview image by double tapping the LCD touchscreen. The area you tap will be magnified, and you can move around the image by dragging your finger around the LCD touchscreen. This is very helpful when checking focus. To return to standard magnification, simply double tap your camera's touchscreen again.

Touch to Focus

You can focus your lens in any region of the image by tapping and holding on the LCD screen in the area that you want to focus. Press the 'focus' button to focus your lens in the chosen location. Double press the focus button to reset the focus point to the center of the screen.

Full Screen Mode

It can be useful when framing or focusing a shot to temporarily hide your touchscreen's status text and meters. To hide them all at once, swipe up or down on the LCD touchscreen. The record indicator, frame guides, grids, focus assist and zebra remain visible.

To show the status text and meters again, swipe up or down again.

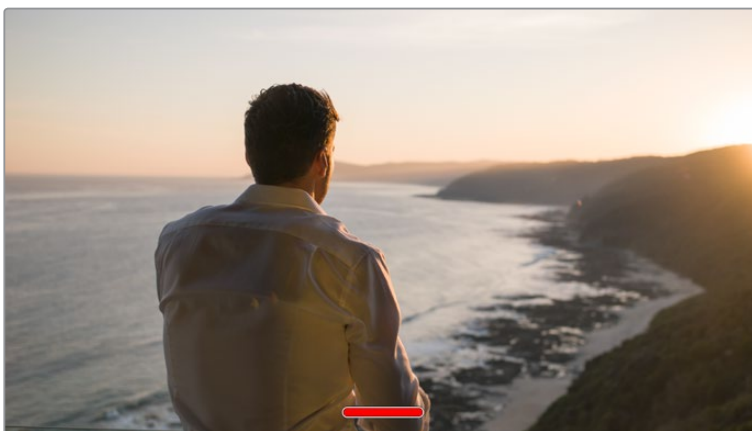

Swipe up or down to hide all status indicators on the LCD touchscreen

Playback Menu

Tap the 'play' control button to access the playback menu. You can control previously recorded clips with your camera's control buttons or the LCD touchscreen.

When using the LCD touchscreen, tap 'play' once to start playback and again to pause. Use the forward and reverse buttons to skip to the start or end of clips. Tapping 'forward' once moves you to the next clip. Press the reverse button once to go to the start of the current clip or press twice to skip back to the start of the previous clip. Playback of clips can also be looped by activating the loop icon.



The reverse, play, forward and loop icons

To shuttle, hold down either the forward or reverse transport buttons. This plays your footage back at twice regular speed in either forward or reverse, depending on which transport key you held.

Once shuttling, you can change the shuttle rate by tapping the transport keys again. Each time you tap the transport key in the same direction you double the shuttle rate. The maximum shuttle rate is x16 normal speed. Tapping the transport key again at x16 speed returns you to x2 speed. Each time you tap the opposite direction, the shuttle speed halves until you reach x2 speed. You can return to normal playback by tapping the 'play' button.



The shuttle speed indicator displays the speed and direction of footage being fast forwarded or reversed

Tapping the 'record' control button in playback mode returns your camera to 'standby' mode, ready to record.

TIP Swipe up or down on the touchscreen to hide status text while playing back footage. Enter the slate in playback mode to mark the current clip 'good take' in metadata. For more information, see the 'entering metadata' section.

Settings

Dashboard

Press the 'menu' button to open your camera's dashboard. This tabbed menu has settings not available from the touchscreen. Settings are divided by function into 'record,' 'monitor,' 'audio,' 'setup,' 'presets,' and 'LUTS' tabs. Each tab has multiple pages, which you can cycle through by tapping the arrows at the edge of your camera's touchscreen, or swiping left or right.

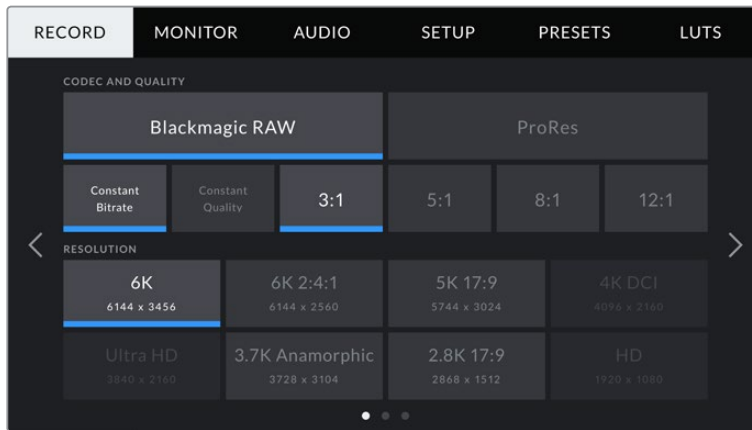

Tap the 'record,' 'monitor,' 'audio,' 'setup,' 'presets,' and 'LUTS' headings to move between your Pocket Cinema Camera's dashboard tabs

Record Settings

The 'record' tab lets you set your video format, codec, and resolution, as well as other settings that are important for your recorded video, such as dynamic range and detail sharpening.

Record Settings 1

The first page of the 'record' settings tab contains the following settings.

Codec and Quality

The 'codec and quality' menu is split into two rows. The top row lets you choose between two codec families, Blackmagic RAW and Apple ProRes, while the bottom row offers quality options in those families. For example, the quality options available in the ProRes codec family are ProRes 422 HQ, ProRes 422, ProRes 422 LT and ProRes 422 Proxy. Blackmagic RAW options are divided between four 'constant bitrate' and two 'constant quality' settings.

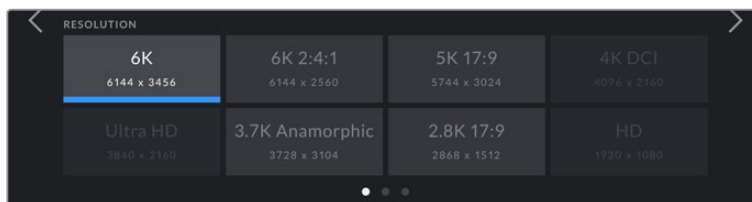

Blackmagic RAW options for 'codec and quality'

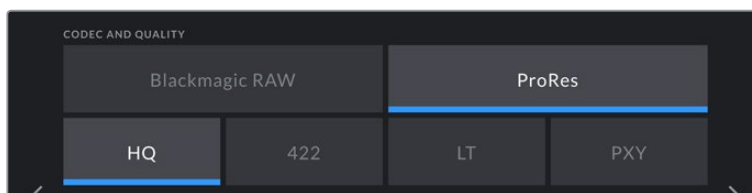

ProRes options for 'codec and quality'

TIP The amount of video you can record on your storage media on Blackmagic Pocket Cinema Camera increases if you choose codecs that use higher compression. Refer to the 'record duration' tables in the 'recording' section for more information.

Resolution

This setting works in combination with the 'codec' setting. Use it to select the resolution for your desired recording format. For example, if you want to record Ultra HD clips using ProRes HQ, select 'ProRes' and 'HQ' in the 'codec and quality' menu. Now choose 'Ultra HD' in the resolution menu.

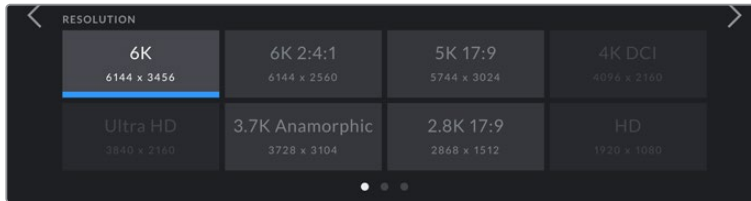

Pocket Cinema Camera 6K 'resolution' options when using Blackmagic RAW codec

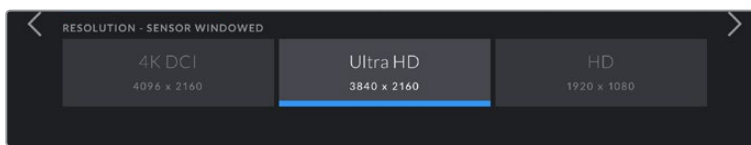

Pocket Cinema Camera 4K 'resolution' options. Note that in 4K DCI format the category is 'resolution', otherwise it's 'resolution - sensor windowed'.

Record Settings 2

The second page of the 'record' settings tab contains the following options.

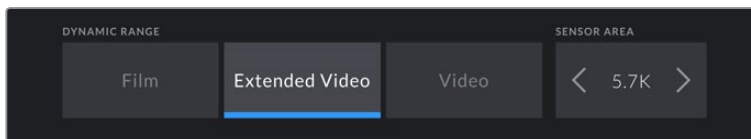

Pocket Cinema Camera 6K options for 'dynamic range' and 'sensor area'

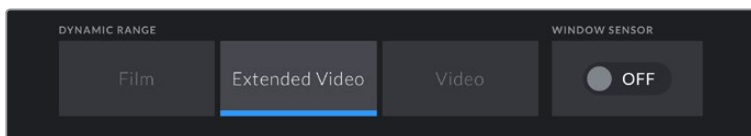

Pocket Cinema Camera 4K options for 'dynamic range' and 'window sensor'

Dynamic Range

Adjust the 'dynamic range' setting by tapping the dynamic range icons. Blackmagic Pocket Cinema Camera has three dynamic range settings:

| | |
|-----------------------|---|
| Film | The 'film' setting shoots video using a log curve that allows you to maintain the greatest dynamic range, and maximizes the information in your video signal to help you get the most out of color grading software, such as DaVinci Resolve. |
| Extended Video | The 'extended video' setting offers a good balance between 'video' and 'film' dynamic range settings. This setting offers a wider dynamic range than 'video,' while applying a mild contrast change with a smooth roll off in the highlights. 'Extended video' is suitable for use with standard broadcast monitors and is a helpful setting if you have limited time for post production and want to record your clips with a pleasing 'look' applied. |
| Video | The 'video' setting is similar to the REC 709 color standard for high definition video. This lets you work faster by recording directly to the compressed video formats in a color space suitable for direct delivery or minimal post processing. |

NOTE When recording Blackmagic RAW and ProRes using 'film' dynamic range, the image will appear dull and desaturated on your touchscreen. This is because the image file contains a lot of data that hasn't yet been graded to suit a standard display. However, while recording film dynamic range, you can monitor the video on the touchscreen and HDMI output using a display LUT, or look up table, designed to simulate a standard contrast. For more information, refer to the LUTs section in this manual.

Window Sensor

Blackmagic Pocket Cinema Camera can be set to use the 'full' sensor area, or for even higher frame rates, you can use 'window' mode. This will use only the amount of sensor pixels needed for a given video format rather than downscaling images from the entire sensor.

As the 'window sensor' mode uses only the center of the camera's sensor, the field of view of any given lens is narrower due to the crop involved. For example, when using a 20mm lens to shoot HD footage in windowed sensor mode, the field of view is equivalent to a 40mm lens on Blackmagic Pocket Cinema Camera 4K.

This setting is available when shooting below your camera's maximum resolution, such as when shooting Ultra HD or HD ProRes video.

The fastest frame rates for Pocket Cinema Camera 6K are available when shooting 2.8K 17:9 windowed and HD scaled from 2.7K windowed. The fastest frame rate for Pocket Cinema Camera 4K is available in HD windowed mode.

Project Frame Rate

The project frame rate provides a selection of frame rates commonly used in the film and television industry. For example, 23.98 frames per second. This frame rate is normally set to match your playback speed and audio sync used in your post production workflow and delivery requirements.

Eight project frame rates are available, including 23.98, 24, 25, 29.97, 30, 50, 59.94 and 60 frames per second.

Off Speed Recording

By default, the project and sensor frame rates are matched for a natural playback speed. However, tapping the 'off speed recording' switch icon lets you set your sensor frame rate independently.

Off Speed Frame Rate

With 'off speed recording' enabled, tap the arrows next to the 'off speed frame rate' indicator to set your camera's sensor frame rate.

The sensor frame rate sets how many actual frames from the sensor are recorded every second, and frame rate will affect how fast or slow your video will play back at your set project frame rate.

For more information on off speed frame rates, see the 'frames per second' section in the 'touchscreen features' section of this manual.

NOTE For information on the maximum frame rates available for each recording format and codec, refer to the tables of maximum sensor frame rates in the 'recording' section of this manual.

Preferred Card for Recording

Use this setting to select which storage card or drive your Blackmagic Pocket Cinema Camera records to first when both slots are in use. The options are 'CFast Card', 'SD Card' and 'Fullest Card'. Picking either 'CFast Card' or 'SD Card' is a matter of personal preference, but using either consistently will let you know which card to swap out first as your storage fills up. 'Fullest card' can help group files chronologically when shooting a single camera project.

The setting you choose is applied when a CFast or SD card is inserted. You can override this setting at any time by entering the storage manager and tapping the card name to set it as active. It's important to note, however, that ejecting and reinserting cards reverts to the current 'preferred card for recording' setting.

TIP The 'fullest card first' setting is based on the percentage that your recording media are filled, rather than their sizes or the amount of data used.

Stop Rec If Card Drops Frame

Use this setting to configure the behavior of your Blackmagic Pocket Cinema Camera when dropped frames are detected. When set to 'off,' recording continues with dropped frames. When set to 'on,' your camera stops recording if dropped frames are detected. This can prevent you wasting time shooting unusable footage if you don't spot the dropped frame indicator.

TIP Refer to the 'Storage Media' section for more information on how to avoid dropping frames.

Record Settings 3

The third page of the 'record' settings tab contains the following settings.

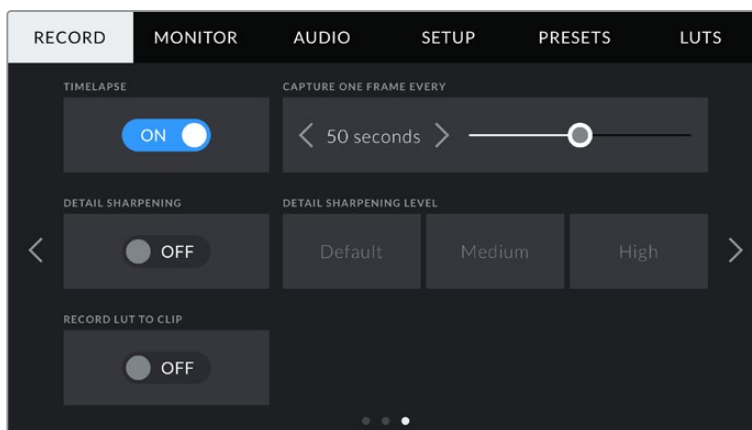

Timelapse

This setting activates the timelapse feature to automatically record a still frame at the following intervals:

| | |
|---------|------------------------|
| Frames | 2 – 10 |
| Seconds | 1 – 10, 20, 30, 40, 50 |
| Minutes | 1 – 10 |

For example, you can set the camera to record a still frame every 10 frames, five seconds, 30 seconds, five minutes etc.

The timelapse feature offers many creative options. For example, setting a two frame timelapse interval gives your recorded video a high speed effect when played back.

Start recording by pressing the record button. When you press the button again to stop recording, the timelapse sequence is saved as one single clip, matching the codec and frame rate set in your camera. This means you can drop the timelapse sequence into your post production timeline just like any other clip you have recorded.



Timelapse mode is indicated by an icon over the 'record' button

TIP When you record clips in timelapse mode, the timecode counter updates when a frame of video is recorded.

Detail Sharpening

Use this setting to sharpen the image. When sharpening is enabled, decrease or increase the level of sharpening by selecting 'default', 'medium' or 'high'.

When sharpening is enabled, it is applied to ProRes video recorded on camera as well as the HDMI output.

This setting is intended for live studio production where there is no time for post production and you want to output the image live to air. We recommend leaving it 'off' for images you are recording for further post production. Detail sharpening is disabled when the codec is set to Blackmagic RAW.

Record LUT to Clip

Your Blackmagic Pocket Cinema Camera does not apply, or 'bake in,' LUTs by default to recorded footage, however you can choose to 'bake in' the LUT to your footage by tapping the 'record lut to clip' switch icon.

This can be a useful option for situations where you do not have the time to grade your footage in post-production, or where you need to give the footage directly to a client or an editor. For more information, refer to the '3D luts' and 'touchscreen controls' sections.

Apply LUT in File

If you are shooting with the Blackmagic RAW codec and applying a LUT to the HDMI output of your camera, the selected LUT will be embedded into the Blackmagic RAW file you are recording. This means that the LUT will be saved in the header of the file and can easily be applied to the clip in post production without needing to handle a separate file. When the 'apply LUT in file' switch is set to 'on' in the record menu, this clip will open in Blackmagic RAW Player and DaVinci Resolve with the chosen LUT already applied to it. The LUT can then be easily toggled 'on' or 'off' but will always travel with the Blackmagic RAW file as it is written into the clip itself.

DaVinci Resolve also has an 'Apply LUT' switch in the RAW settings palette for enabling or disabling the 3D LUT in the Blackmagic RAW file. The 'Apply LUT' setting in DaVinci Resolve is the same setting as in the camera. This means that when shooting you can direct the colorist to use the LUT by setting it in the camera, but they can switch it off easily in DaVinci Resolve by setting 'Apply LUT' to 'off'.

File Naming Convention

Clips are recorded to your CFast card, or SD card or USB-C flash disk in the Blackmagic RAW format or to a ProRes QuickTime movie, depending upon which recording format you have chosen.

The table below shows an example of the file naming convention:

| A001_08151512_C001.mov | QuickTime Movie Filename |
|---------------------------------|---------------------------------|
| A001_08151512_C001.mov | Camera index |
| A 001 _08151512_C001.mov | Reel Number |
| A001_ 08 151512_C001.mov | Month |
| A001_08 15 1512_C001.mov | Day |
| A001_0815 15 12_C001.mov | Hour |
| A001_081515 12 _C001.mov | Minute |
| A001_08151512_ C001 .mov | Clip Number |

Still image files captured using the still button follow the file naming convention for video clips, however the filename has 'S001' representing the 'still number' as the last four characters of the filename in place of the clip number. For information on how to change the camera index, see the 'Project Metadata' section.

Monitor Settings

The 'monitor' tab lets you adjust status text, overlays, and other monitoring options for your Blackmagic Pocket Cinema Camera's LCD touchscreen and the HDMI output. Options are arranged by output between 'LCD', 'HDMI' and 'both', which covers monitor settings that affect the LCD and the HDMI output. These menus have two pages of options, which you can cycle through by tapping the arrows at the edge of your camera's touchscreen, or swiping left or right.

Monitor Settings 1

The first page of the monitor tab contains identical settings for each output. For example, you can set 'zebra' on for the LCD touchscreen, but off for the HDMI output.

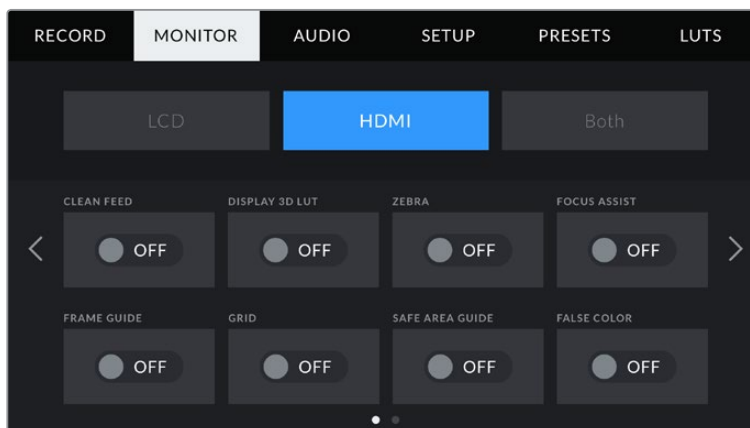

Clean Feed

Tap the 'clean feed' switch in the 'LCD' or 'HDMI' menus to disable all status text and overlays for that output, except the record tally indicator.

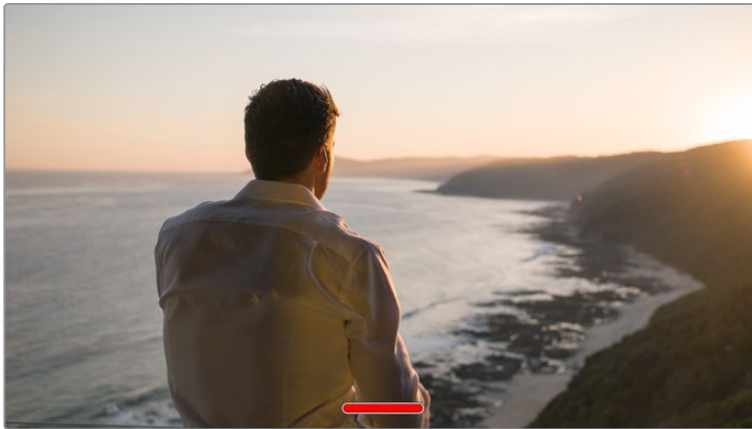

Your camera will display a record tally even in clean feed mode

NOTE LUTs will still be applied to outputs with 'clean feed' enabled. To disable LUTs, disable the 'display LUT' switch in the 'Monitor' menu.

Display 3D LUT

Your Blackmagic Pocket Cinema Camera can apply 3D LUTs to any output to approximate the look of color graded footage. This is especially useful when recording clips using 'film' dynamic range.

If your camera has a 3D LUT active, use this setting to independently apply that LUT to your LCD touchscreen or HDMI output.

For more information on loading and using 3D LUTs, see the '3D LUTs' section of this manual.

Tap the switches on the 'LCD' or 'HDMI' pages to enable monitoring options for the LCD touchscreen and the HDMI output: focus assist, frame guide, grid, safe area guide, false color.

Zebra

Tap the 'zebra' switch in the 'LCD' or 'HDMI' menus to enable zebra guides for those outputs. For more information on zebra guides and setting zebra levels, see the 'touchscreen features' section in this manual.

Focus Assist

Tap the 'focus assist' switch in the 'LCD' or 'HDMI' menus to enable focus assist for those outputs. For more information on focus assist and setting focus assist levels, see the 'touchscreen features' section in this manual.

Frame Guide

Tap the 'frame guide' switch in the 'LCD' or 'HDMI' menus to enable frame guides for those outputs. For more information on frame guides and choosing different guides, see the 'touchscreen features' section in this manual.

Grid

Tap the 'grid' switch in the 'LCD' or 'HDMI' menus to enable a rule of thirds grid for those outputs. For more information on the rule of thirds grid, see the 'touchscreen features' section in this manual.

Safe Area Guide

Tap the 'safe area' switch in the 'LCD' or 'HDMI' menus to enable safe area overlay for those outputs. For more information on the safe area guide, see the 'touchscreen features' section in this manual.

NOTE Use the 'safe area guide %' setting in your Blackmagic Pocket Cinema Camera's 'both' monitoring settings to set the size of the safe area guide.

False Color

Tap the 'false color' switch in the 'LCD' or 'HDMI' menus to enable false color exposure assistance for those outputs. For more information on using false color, see the 'touchscreen features' section in this manual.

LCD Monitor Settings 2

The second page of the 'LCD' monitor tab contains settings unique to your LCD touchscreen.

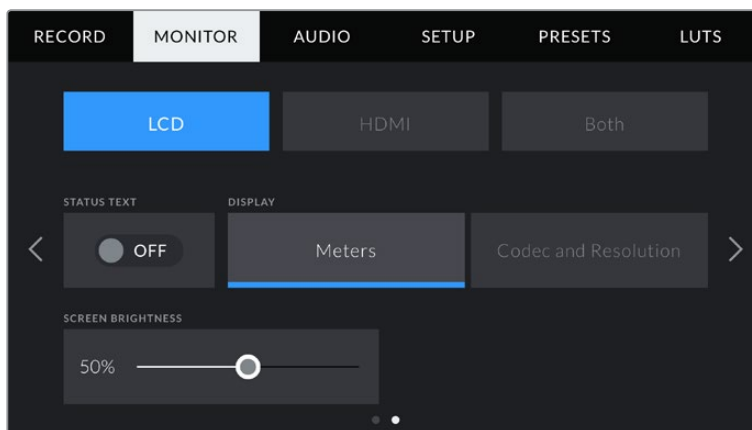

'Status text' gives you a clear view of your camera's preview image

Status Text

This setting can be useful to hide the status text and meters on your LCD touchscreen, leaving only the information necessary to compose or direct a shot. Tap the 'status text' switch icon to toggle the appearance of status text and meters for your camera's LCD touchscreen. Overlays such as frame guides, grids, focus assist and zebra remain visible, if enabled. Swiping up or down on the LCD touchscreen has the same effect.

Display

Instead of a histogram and audio meters, your camera can display codec and resolution information at the left and right bottom edges of the LCD touchscreen. This can be useful if you prefer to use false color for dialling in exposure, or are recording audio separately and want to display additional information in the space normally used by the histogram and audio meter.

Simply tap 'meters' or 'codec and resolution' in the 'LCD' menu to select your preferred view.

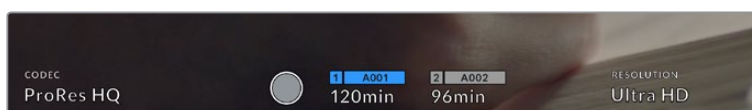

Your Blackmagic Pocket Cinema Camera can display codec and resolution information in place of the histogram and audio meters

Screen Brightness

Drag the 'screen brightness' slider in the 'LCD' menu left or right to adjust the brightness of your camera's LCD touchscreen.

HDMI Monitor Settings 2

The second page of your 'HDMI' monitor tab contains settings unique to your HDMI output.

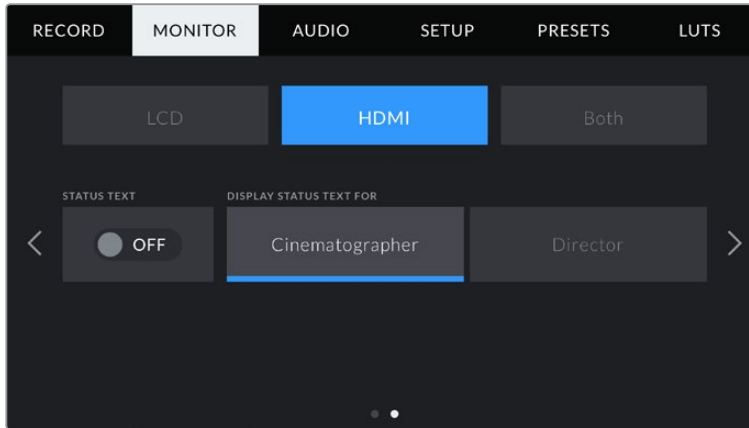

Status Text

It can be useful to hide the status text and meters on your HDMI output, leaving only the information necessary to compose or direct a shot. Tap the 'status text' switch icon in the HDMI monitor menu to toggle the appearance of status text and meters. Overlays such as frame guides, grids, focus assist and zebra remain visible, if enabled.

To hide or reveal status text and meters on the touchscreen, simply swipe up or down.

Display Status Text For Cinematographer or Director

The LCD touchscreen displays information such as ISO, white balance, and aperture that is useful to a camera operator or cinematographer setting up individual shots on that camera. Your camera's HDMI output, however, can also show information useful to a director or script supervisor who is keeping track of multiple shots or cameras.

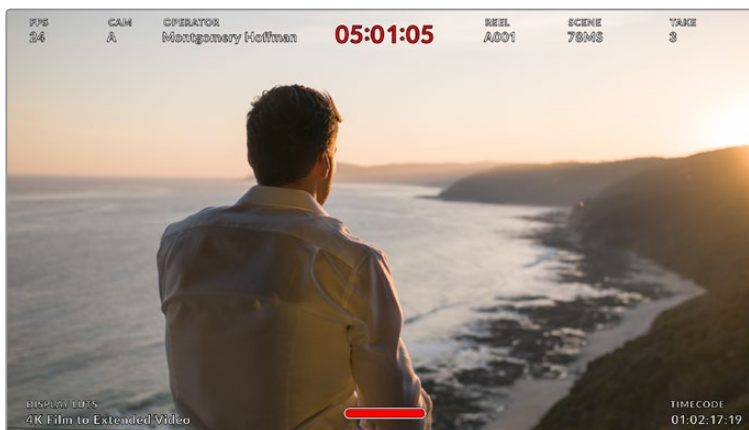

Your Blackmagic Pocket Cinema Camera can display director specific status text on its HDMI output

Setting the status text to 'director' in the HDMI monitor settings changes the status text for that output to show the following information.

- **FPS**
Displays the currently selected frames per second for that camera. If off speed frame rate is disabled, only the project frame rate is shown. If an off speed frame rate is being used, the sensor frame rate is shown, followed by the project frame rate.
- **CAM**
Displays the camera index as set in your camera's slate. For more information, see the 'slate' section.
- **OPERATOR**
Identifies the camera operator as set in your camera's slate. For more information, see the 'slate' section.
- **DURATION DISPLAY**
Displays the duration of the current clip while recording, or the last recorded clip in the following format: hours:minutes:seconds.
- **REEL, SCENE, TAKE**
Displays the current reel, scene and take. For more information on reels, scenes, takes and their labelling conventions, refer to the 'slate' section.
- **DYNAMIC RANGE**
The bottom left hand corner of the monitor displays the currently applied LUT, if applied to that output. If no LUT is applied, 'film' or 'video' dynamic range is displayed.
- **TIMECODE**
The bottom right of the monitor displays your camera's timecode, in the following format: hours:minutes:seconds:frames.

Both Monitor Settings 1

Monitor settings that affect both your camera's LCD and the HDMI output are grouped in the 'both' menu. For example, setting 'safe area guide %' to 90% in this menu sets the safe area guide to 90% for your camera's LCD and HDMI output.

Monitor settings for both are displayed over 2 pages, containing the following settings.

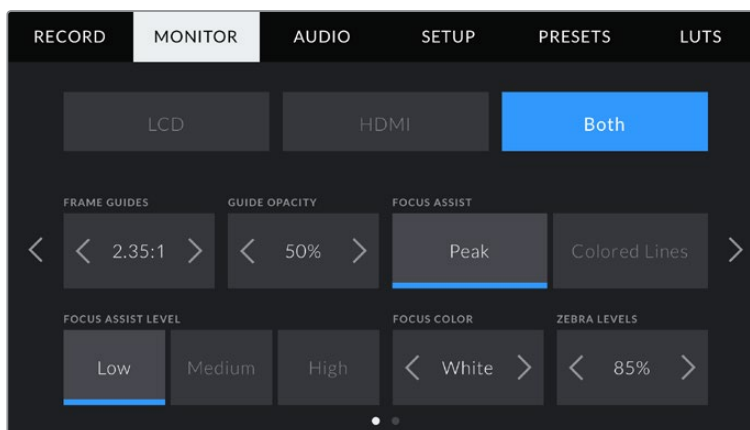

Frame Guides

Tap the left or right arrows in the 'frame guides' menu setting to cycle through seven frame guide options for all outputs on your camera. The options are detailed in the 'touchscreen features' section of this manual, and are also accessible from the LCD monitoring menu in your LCD touchscreen head up display. It's worth noting that you can individually select whether frame guides appear on the LCD touchscreen and HDMI output in their respective 'monitor' menus.

Guide Opacity

Tap the left or right arrows in the 'guide opacity' menu setting to choose the opacity of the areas blocked out by frame guides on your LCD touchscreen and HDMI output. The options are 25%, 50%, 75% and 100%.

Focus Assist

Your camera has two focus assist modes, including 'peak' and 'colored lines.'

| | |
|----------------------|--|
| Peak | When 'peak' style focus assist is selected, areas of the shot that are in focus are heavily sharpened on your LCD touchscreen or HDMI output, but not in the recorded image itself. This causes focused parts of your shot to 'pop' out of the softer background on screen. As no additional overlays are used, this can be a very intuitive way to tell when focus is dialed in, especially when the subject you're focusing on is physically well separated from other elements in shot. |
| Colored Lines | When 'colored lines' style focus assist is selected, a colored line is superimposed around the parts of the image that are in focus. This can be a little more intrusive than 'peak' style focus assistance as the lines are drawn over your image, but especially in busy shots with a lot of visible elements, it can be a precise focus aid. |

Focus Assist Level

To set the level of focus assistance for your LCD and HDMI output, tap the 'low,' 'medium' or 'high' setting.

NOTE Setting the focus assist intensity level does not affect whether focus assistance is enabled on your Blackmagic Pocket Cinema Camera's LCD and HDMI output. You need to turn focus assistance on individually for each output in the LCD and HDMI output monitor menus.

TIP The optimum level of focus assistance varies shot by shot. When focusing on actors, for example, a higher level of focus assistance can help resolve edge detail in faces. A shot of foliage or brickwork, on the other hand, may show distracting amounts focus information at higher settings.

Focus Color

Use this setting to change the color of focus line overlays when using 'colored lines' style focus assistance. Changing the focus line color can make it easier to tell focus assistance lines apart from your image. The available options are 'white,' 'red,' 'green,' 'blue' and 'black.'

Zebra Levels

Set the exposure level that zebra appears at by tapping the arrow icons on either side of this setting. Zebra level is adjustable in five percent steps between 75 and 100 percent exposure.

For more information, see the 'zebra' guide in the 'touchscreen features' section of this manual.

Monitor Settings 2

The second page of the 'both' monitor tab contains the following options:

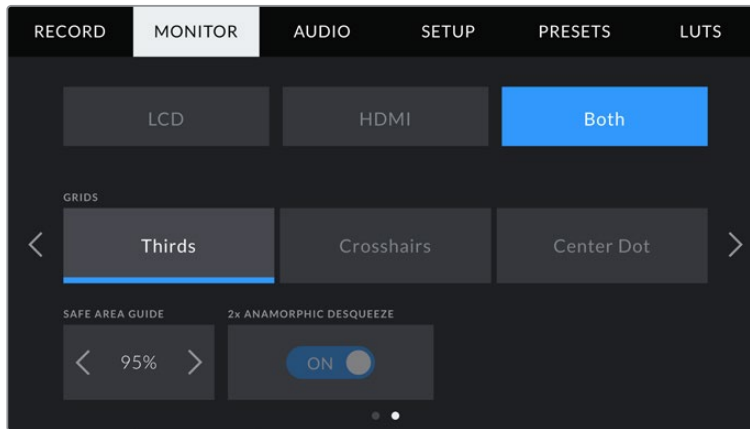

Page 2 of 'monitor' options for both LCD and HDMI on Pocket Cinema Camera 6K

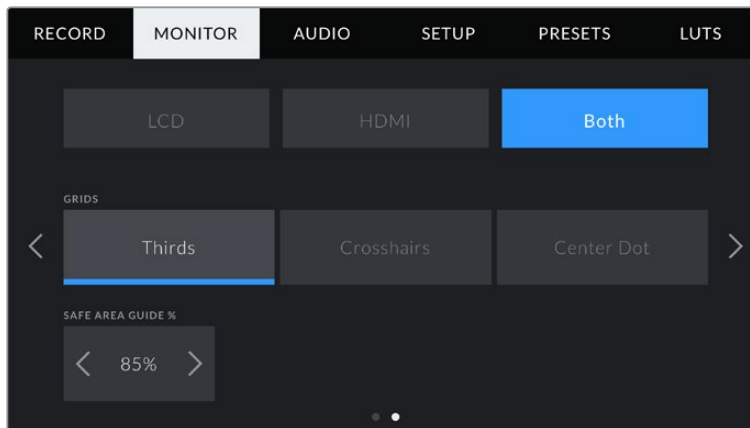

Page 2 of 'monitor' options for both LCD and HDMI on Pocket Cinema Camera 4K

Grids

To set which combination of grids and crosshairs you want to display on your camera's LCD touchscreen and HDMI output, tap the 'thirds,' 'crosshairs,' or 'center dot' options in this setting.

For more information, see the 'grids' guide in the 'touchscreen features' section.

Safe Area Guide %

Adjust the size of the safe area overlay on the touchscreen and HDMI output by tapping the arrows to the left and right of the percentage displayed in this setting. This percentage indicates the size of the safe area in relation to the image frame. Most broadcasters require a 90% safe area.

Anamorphic Desqueeze

Pocket Cinema Camera 6K can apply an anamorphic desqueeze to the LCD touchscreen and HDMI output. When you record in 3.7K 6:5 anamorphic format it automatically applies '2x anamorphic desqueeze', and in 16:9 formats you can enable '1.33x anamorphic desqueeze'.

Audio Settings

The 'audio' tab lets you adjust the audio input and monitoring settings on your camera.

The audio settings for the camera are spread over two pages and divided between channels 1 and 2.

You can map each audio channel to a different source, as well as adjusting various settings such as gain control.

Audio Settings 1

The first page of the 'audio' tab contains the following settings.

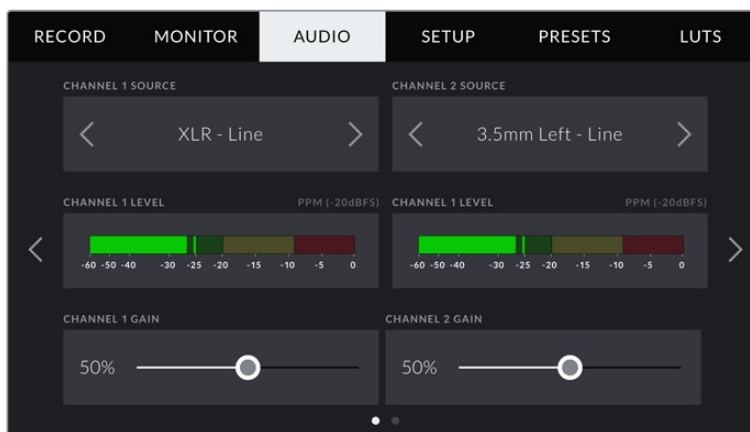

Channel Source

Use the 'channel 1 source' and 'channel 2 source' buttons to select your audio source for each audio channel. Below is a description of each channel source setting.

- **Camera Left or Right**
Records from your camera's internal microphones.
- **Camera Mono**
Creates a single audio channel from your Blackmagic Pocket Cinema Camera's built in microphone's left and right channels.
- **XLR Line**
Uses your camera's XLR input to record line level audio.
- **XLR Mic**
Records mic level audio from your camera's XLR input. If phantom power is enabled and you have your XLR input set to 'mic' you'll also see a '+48V' indicator here. It is also important to ensure that the 48V switch gets turned 'off' when you disconnect your phantom powered microphone.
- **3.5mm Left – Line**
Uses only the left channel of the 3.5mm input as line level audio.
- **3.5mm Right – Line**
Uses only the right channel of the 3.5mm input as line level audio.
- **3.5mm Mono – Line**
Creates a mono mix of the left and right channel from the 3.5mm input as line level audio.

- **3.5mm Left – Mic**
Uses only the left channel of the 3.5mm input as mic level audio.
- **3.5mm Right – Mic**
Uses only the right channel of the 3.5mm input as mic level audio.
- **3.5mm Mono – Mic**
Creates a mono mix of the left and right channel from the 3.5mm input as mic level audio.
- **None**
Disables your audio channel.

NOTE When selecting the 3.5mm input as an audio source, the channel 1 and channel 2 source both need to be line level or mic level. This means that if you select '3.5mm left - line' as your channel 1 source, the available options for the 3.5mm input on channel 2 will all be line level: '3.5mm left - line', '3.5mm right - line' and '3.5mm mono - line'. The mic level options will be grayed out.

Channel 1/2 Level

The level meters help you set the correct audio level.

Channel 1/2 Gain

Use these sliders to adjust the recording levels of your chosen channel 1 and 2 sources.

Audio Settings 2

The second page of the 'audio' tab contains the following settings.

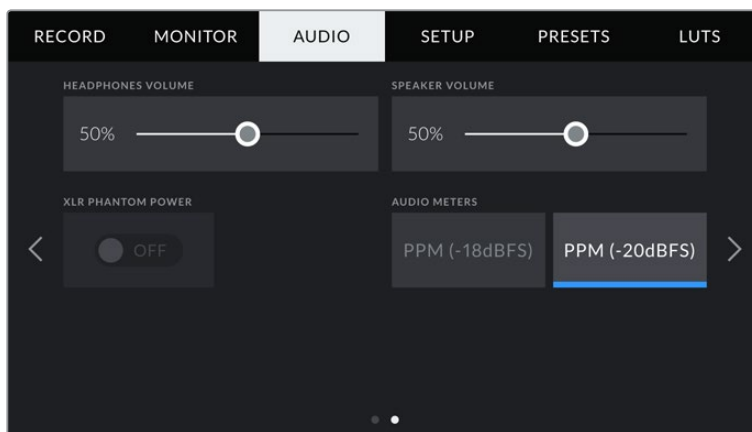

Headphones Volume

This slider adjusts the output levels for headphones attached to the 3.5mm headphone jack. Move the audio slider left or right to adjust levels.

Speaker Volume

This slider adjusts the output levels for the built in speaker. Move the audio slider left or right to adjust levels.

XLR Phantom Power

Your camera's XLR input can provide 48V phantom power so you can use microphones that aren't self powered. When your camera is set to 'XLR' audio input, simply tap the 'phantom power' switch icon to enable phantom power.

Audio Meters

Select an 'audio meters' standard for the peak level meters.

| Audio meter setting | Standard |
|---------------------|---------------|
| PPM (-20 dBFS) | SMPTE RP.0155 |
| PPM (-18 dBFS) | EBU R.68 |

NOTE It is standard practice to plug in your XLR cable before switching phantom power on. It is also important to switch phantom power to 'off' when you no longer have a phantom powered microphone connected. Connecting equipment that doesn't require phantom power when still in phantom power mode can damage your equipment, as the camera outputs a charge when in this mode. Phantom power can also take quite a while to discharge after switching it off.

Please be aware that you should wait a few minutes when switching off phantom power before plugging in any other microphones or XLR audio equipment.

Setup Settings

The 'setup' tab contains your Blackmagic Pocket Cinema Camera's identification settings, software version, function button settings and other camera settings not directly linked to recording or monitoring. This menu has four pages, which you can cycle through by tapping the arrows at the edge of the LCD touchscreen, or swiping left or right.

Setup Settings Page 1

The first page of your camera's 'setup' tab contains the following settings.

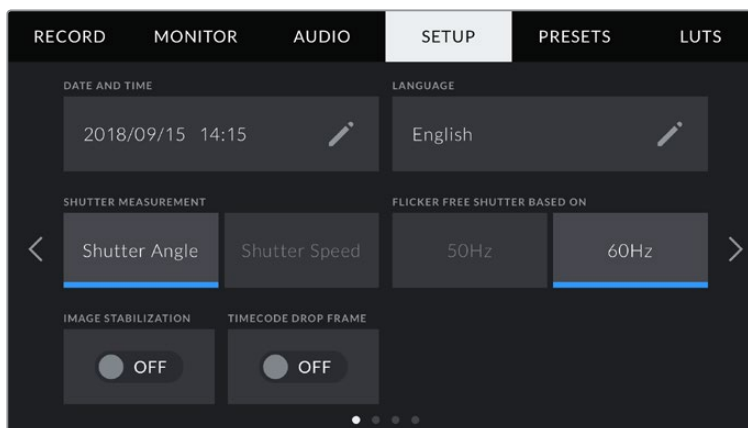

Date and Time

Set your camera's date and time by tapping the 'date and time' setting. The date format is year, month, day and the time format is 24 hour. Date and time are also used for time of day timecode if an external timecode source is not connected.

Language

Tap the 'language' setting to change the language of your camera's menus and status text. English is the only language available currently but more are planned for upcoming software updates.

Shutter Measurement

Use this setting to select whether to display shutter information as 'shutter angle' or 'shutter speed'.

It's worth mentioning that when using shutter angle, the shutter conforms to the frame rate. For example, 180 degrees produces the same motion blur, no matter which frame rate you use.

When using shutter speed, however, the shutter is given an absolute value determined independently of the frame rate, so the results differ if you change the frame rate.

For example, when shooting at 24 frames per second, a 1/48th of a second shutter speed produces pleasing motion blur at the equivalent of a 180 degree shutter angle. Change the frame rate to 48 frames per second and 1/48th of a second shutter speed no longer offers the same motion blur, now producing the equivalent of a 360 degrees shutter angle. In this example, when the frame rate is changed to 48 fps, you would also need to change the shutter speed to 1/96th of a second to produce the same effect as a 180 degree shutter angle.

Flicker Free Shutter Based On

Use this setting to change the mains power frequency your camera uses to calculate flicker free shutter settings.

When shooting under lights, your shutter can affect the visibility of flicker. Your Blackmagic Pocket Cinema Camera automatically calculates a flicker free shutter value for your current frame rate and suggests up to three shutter values. Shutter values are affected by the frequency of the local mains power supply used to drive those lights. In most PAL countries, this frequency is 50Hz, while NTSC countries typically use 60Hz power. Tap '50Hz' or '60Hz' to set the right frequency for your region.

NOTE Characteristics of various light sources may still cause flicker even when using flicker free shutter values. We recommend performing a test shoot when not using continuous lights.

Image Stabilization

Pocket Cinema Camera 4K has an 'Image Stabilization' option to enable or disable image stabilization on lenses without a physical switch.

Timecode Drop Frame

Use the 'timecode drop frame' option to use drop frame timecode when using NTSC project frame rates of 29.97 and 59.94. Drop frame timecode skips a small number of frames from the timecode at set intervals. This keeps your project timecode accurate despite each second not containing a whole number of frames at NTSC frame rates.

Setup Settings Page 2

The second page of the 'setup' tab contains the following settings.

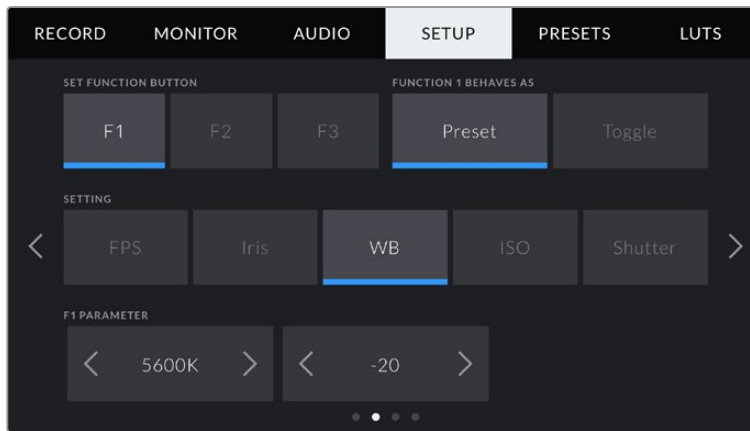

Set Function Button

On the top of your Blackmagic Pocket Cinema Camera you'll notice three function buttons. The dots on the buttons represent function 1, function 2 and function 3. These can be mapped to frequently used features and are quickly accessible when using your camera.

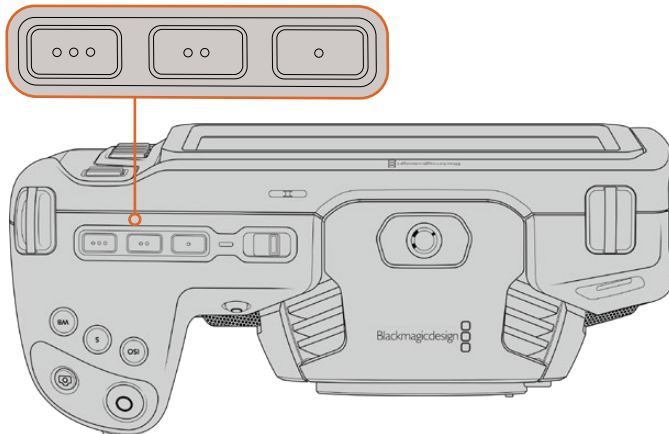

The function buttons are represented by dots and are located on the top of your camera

To set these buttons, select a function button and then the behavior, settings and parameters you want for that function.

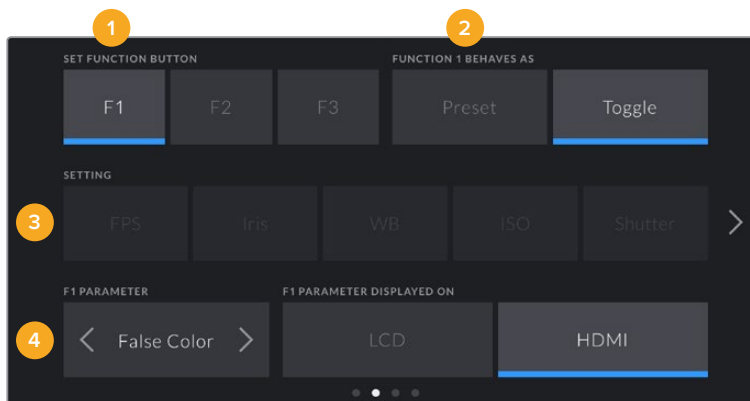

1 Button 2 Behavior 3 Setting 4 Parameter

Function 1/2/3 Behaves as

Once you have selected the function button you want to map, you can select a behaviour. The available options are:

| | |
|----------------------|--|
| Preset | <p>When set to this behavior, pressing a function button recalls a combination of a setting and a parameter.</p> <p>To set a preset, select the setting you want to use from the 'setting' menu, and adjust that setting by tapping the arrow icons on either side of the 'parameter' menu.</p> <p>For example, to set the F1 button to recall a preset aperture of f8, select the 'preset' behavior, tap the 'iris' setting, and tap the arrows on either side of the 'parameter' menu until you get to f8.' Tapping the preset again returns your camera to the previous setting.</p> |
| Toggle On/Off | <p>When set to this behavior, pressing a function button toggles a particular setting on or off. The 'setting' menu is greyed out in this mode. Instead, tap the left or right arrows in the parameter menu to scroll through the available options. These are 'off speed recording', 'ois', 'clean feed', 'display LUT', 'frame guides', 'focus assist', 'false color', 'zebra', 'grid' and 'safe area guide'.</p> <p>Use the 'Toggle On/Off' behaviour to select the output this setting applies to. Tap any combination of 'LCD' and 'HDMI' to select. If the output for an option cannot be selected, such as 'color bars' which always applies to all outputs, the separate 'LCD' and 'HDMI' settings are disabled.</p> |

Setup Settings Page 3

The third page of the 'setup' tab contains the following settings.

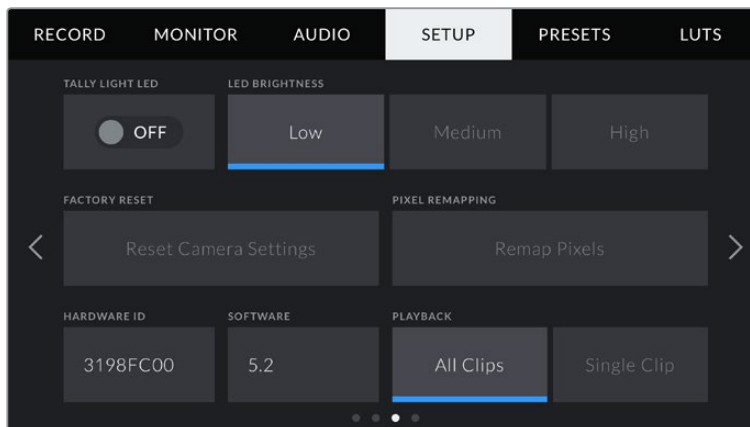

Tally Light LED

Your Blackmagic Pocket Cinema Camera has a tally light on the front of the camera that illuminates red when your camera is recording. The tally light can be enabled or disabled by tapping the 'tally light LED' switch icon.

LED Brightness

To set the brightness of the tally light LED, tap 'low,' 'medium,' or 'high.'

Factory Reset

To reset the camera to its default factory settings, tap the 'reset' button. After you approve this action on the confirmation page, your camera erases any stored LUTs and presets, and resets all settings. This process can take up to two minutes to complete.

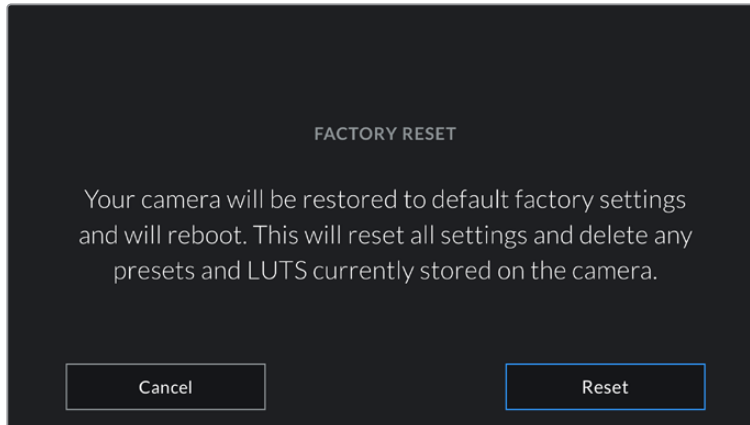

When selecting 'reset' you will be prompted to confirm your action

Remap Pixels

The CMOS sensor used in your Blackmagic Pocket Cinema Camera is made up of millions of pixels that respond to light. Some pixels can change in brightness over time following sensor calibration in the factory. As a result, they become more visible and become what is known commonly as hot pixels. All camera sensors, regardless of manufacturer, will develop hot pixels.

To solve this, we have a calibration feature built into the camera which you can run if you see any hot pixels in the image.

To begin this process, simply put on the lens cap and run the pixel remapping feature by tapping the 'remap pixels' button. The process takes approximately one minute to complete.

Hardware ID

The 'Hardware ID' indicator displays an 8 character identifier for your Blackmagic Pocket Cinema Camera. This is unique to each camera. A longer, 32 character version of this ID is also included in the metadata for Blackmagic RAW and ProRes video. This can be useful for identifying which footage came from a particular camera.

Software

Displays the version number of currently installed software. See the 'Blackmagic Camera Setup Utility' section for more information on updating software.

Playback

This setting allows you to select whether to play back a 'single clip' or 'all clips' on the LCD touchscreen from SD card, CFast card or USB-C flash disk. 'All clips' plays back through all matching media sequentially, and 'single clip' plays one clip at a time. This also applies for the loop function. Selecting loop on 'all clips' plays through all of the clips on the recording media and then loop. Selecting 'single clip' loops one clip at a time.

Setup Settings Page 4

The fourth page of your camera's 'setup' tab contains these Bluetooth® settings.

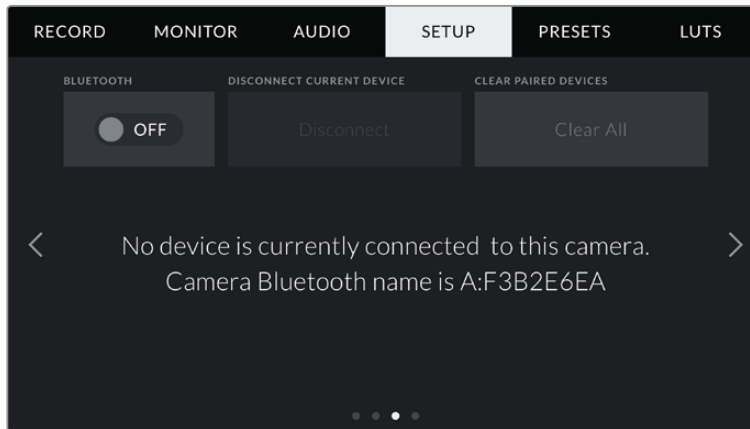

The camera Bluetooth name will be the letter of your camera as selected in the slate, followed by the 8 character hardware ID for your camera

Bluetooth®

Bluetooth control lets you control your camera wirelessly from portable devices. Using the 'Blackmagic Camera Control App' you can change settings, adjust metadata and trigger record remotely from an iPad. Enable or disable Bluetooth by tapping the 'Bluetooth' switch icon in the 'setup' menu. When Bluetooth is enabled, the camera can be detected by Bluetooth devices up to 30 feet away. Your camera uses the same set of commands for Bluetooth control as it does for 'Blackmagic SDI Camera Control Protocol', so you can write your own applications to control almost every setting in the camera remotely. For example, monitoring options and audio settings, to the camera's inbuilt DaVinci Resolve color corrector or even lens control.

For more information see the 'Blackmagic Camera Control' document available at <https://www.blackmagicdesign.com/au/developer/>

To pair your camera with an iPad for the first time:

- 1 Enable Bluetooth by tapping the 'Bluetooth' switch icon in the 'setup' menu.
- 2 Open the 'Blackmagic Camera Control App' and select the camera you would like to pair it with. Available cameras are listed by a camera letter, followed by a unique hardware ID. For example A:A0974BEA.

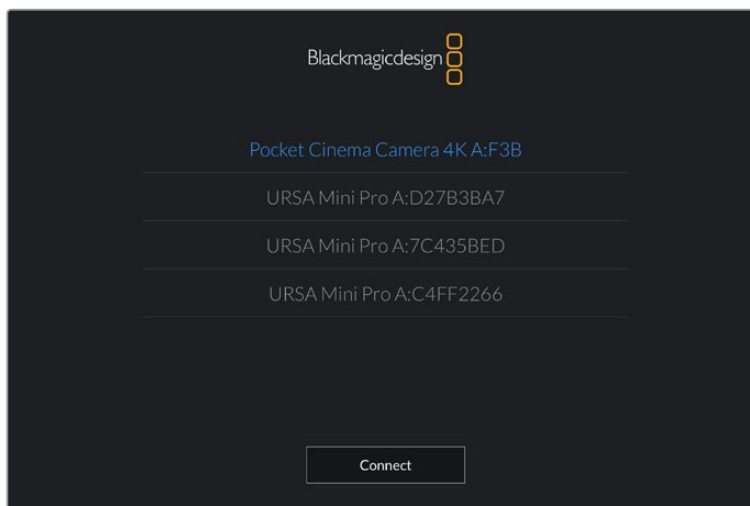

Select the Blackmagic Pocket Cinema Camera you would like to pair with

NOTE When you install the Blackmagic Camera Control App and run it for the first time, you will be asked if you want to 'allow location access.' If you select 'while using the app,' GPS readings from your iPad will be included in the metadata of the files you shoot, allowing you to geotag your footage. This information can be viewed in Blackmagic DaVinci Resolve version 15 or higher.

If you do not want to allow the use of this information, select 'never.'

To change settings, go to settings, privacy, location services, camera control on your iPad.

- 3 When you try to connect for the first time the Blackmagic Camera Control App will request a six digit code to pair with the camera. This code will be displayed on the camera's LCD screen. Type this code into the iPad and press 'pair'.

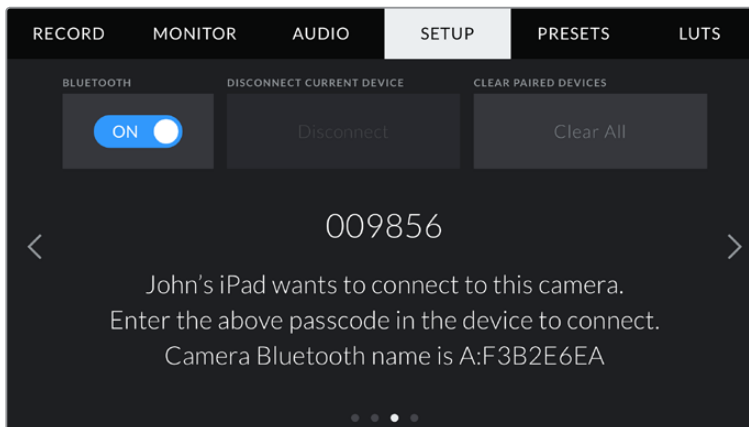
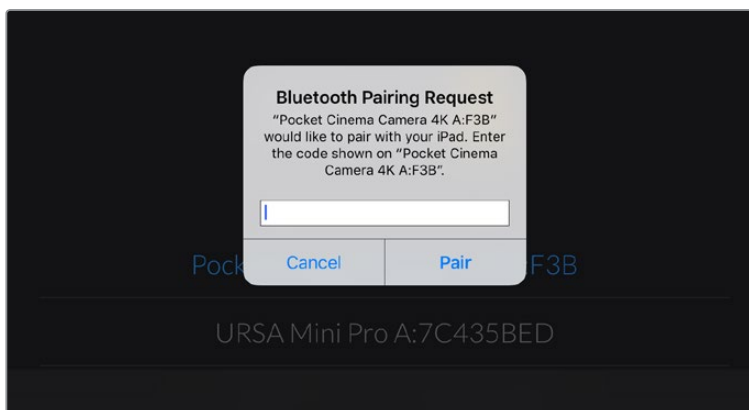

- 4 When your camera connects to your iPad, it confirms it is paired.

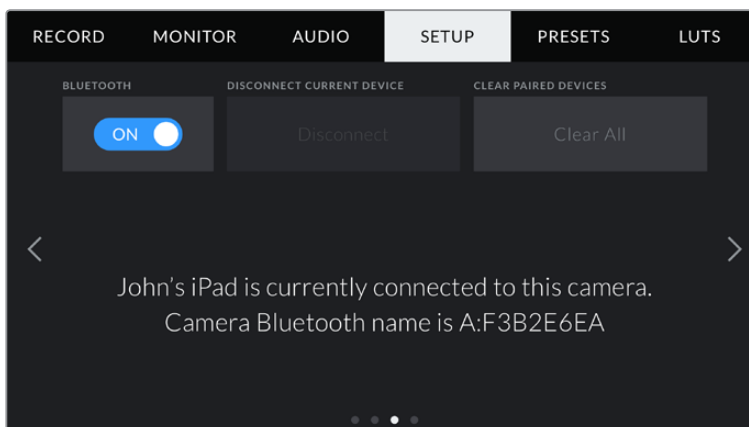

- 5 If pairing the camera to your iPad fails, the camera presents an error message. Try connecting again.

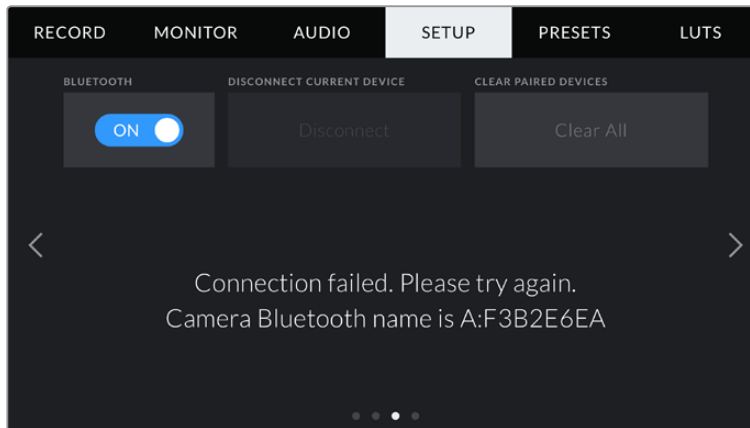

NOTE If you are not using Bluetooth to control your Blackmagic Pocket Cinema Camera, it is a good idea to turn Bluetooth off for the purpose of security.

Disconnect Current Device

Use this setting to disconnect your Blackmagic Pocket Cinema Camera from the iPad it is currently paired with.

Clear Paired Devices

Use this setting to clear the list of devices that your camera has been paired with.

Controlling Your Camera with the Blackmagic Camera Control App

Once you have successfully paired your camera to your iPad, you can change settings, adjust metadata and trigger record remotely using the iPad app.

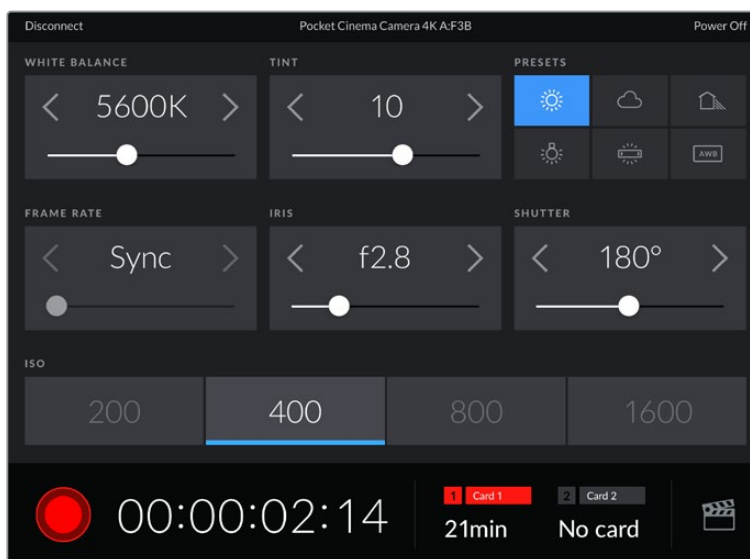

Once paired, the Blackmagic Camera Control app will display this screen, allowing you to adjust your settings and start recording

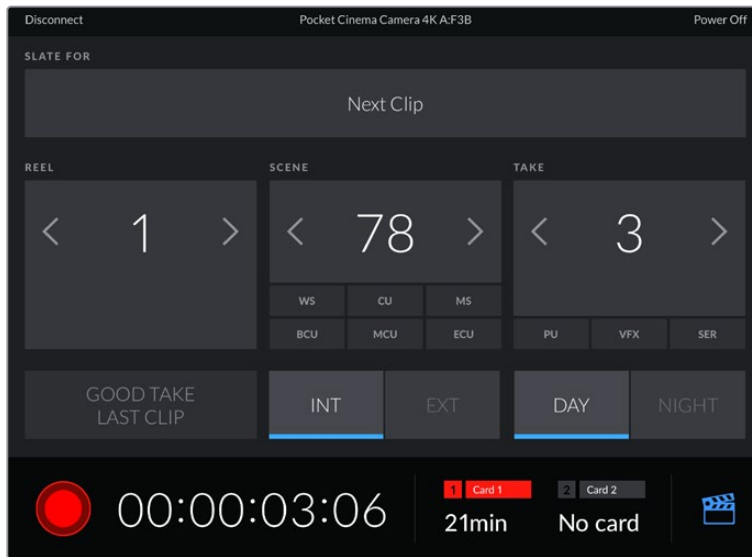

Tap the slate icon in the lower right corner to access and update the slate

Blackmagic Pocket Cinema Camera uses Bluetooth LE to communicate with devices for wireless control. This is the same type of protocol used in portable devices, and uses a minimal amount of battery power.

Presets

The 'presets' tab lets you save and recall up to 12 collections of settings. This is very useful when one camera is used for multiple projects. For example, you may use your camera for a variety of different shoots, from documentaries to music videos, with very different settings between types of projects. Your camera's 'presets' function lets you save the setup for a particular project or type of shoot and come back to it quickly and easily when required. You have 12 preset slots to use.

You can also import and export presets, which is very useful for setting up a multi camera shoot. Simply set up one Blackmagic Pocket Cinema Camera to suit your project, then export that preset for all the other Blackmagic Pocket Cinema Cameras on set.

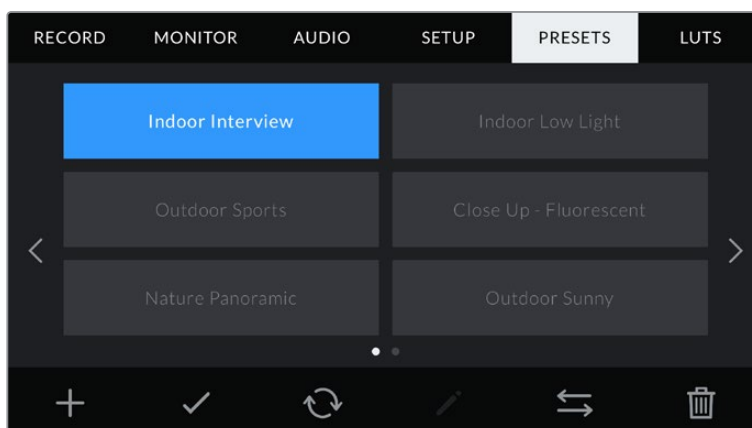





The presets tab allows you to quickly switch between settings that you have saved

NOTE Your camera can save up to 12 presets to its internal memory.

Preset buttons

The button icons along the bottom of the 'preset' menu correspond with the following functions.

| | | | | |
|---|---|---|---|---|
|  |  |  |  |  |
| Add | Load | Update | Manage | Delete |

Saving and loading presets

To create a new preset, tap the 'add' icon. This brings up a touch keyboard on your LCD where you can name your preset. Enter a name and tap 'update' to save all of your current settings to that preset.

If your camera already has a preset loaded with the same name, you can choose to overwrite the existing preset or keep both.

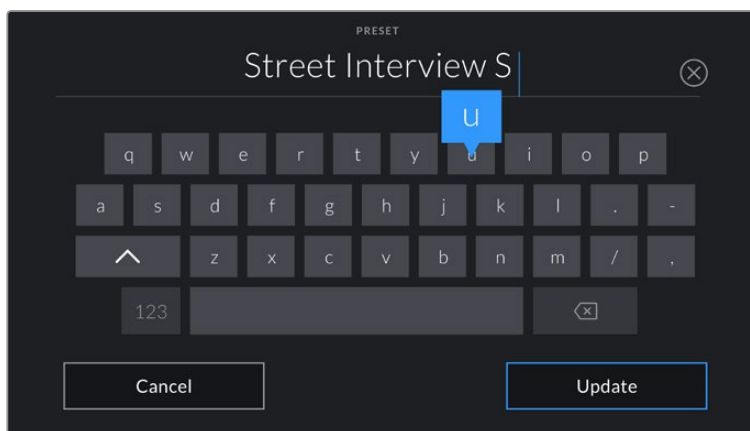

Enter a name for your preset by tapping the 'add' icon in the preset tab and using the touch keyboard

Once you have a preset saved, tap its name in the preset menu to select it. To load a preset, tap the 'load' icon.

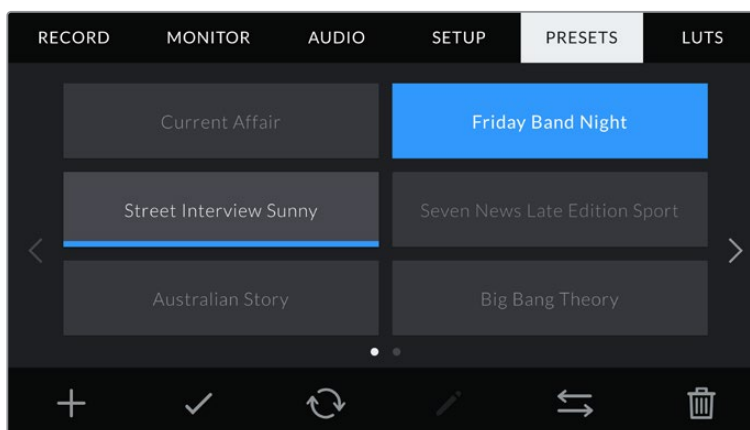

Select a preset and tap the 'load' icon to load it. Selected presets will appear solid blue, while currently loaded presets have a blue line along the bottom of their icon

You can update a preset by tapping the 'update' icon. This will bring up a prompt asking you if you want to update the preset with your Blackmagic Pocket Cinema Camera's current setting. Tap 'update' to confirm.

Importing presets

To import a preset, tap the 'manage' icon at the bottom of the 'presets' menu. Tap 'import presets', then tap 'import' to confirm. This brings up the presets import screen. If your preferred preset is not on the active card or drive, switch between recording media by tapping a media button at the top of the touchscreen. You can import presets from a USB-C flash disk, CFast or SD card.

Your camera searches the root directory and 'Presets' folder on your selected media, and lists available presets. Any presets you have saved elsewhere are not visible.

Tap a preset to select it, then tap 'import' to confirm your selection and copy it to the next available slot on the camera.

NOTE If all 12 of your camera's preset slots are full, the import menu is unavailable, and you need to delete an existing preset to make room.

If the preset you want to import has the same name as a preset already saved to your camera, you can choose to overwrite the existing preset or keep both. At the top right of this screen, you'll see the number of remaining empty preset slots available on your camera. You are able to import as many presets as you have free slots on your camera.

Exporting presets

To export a preset to a card or USB-C flash disk, tap the preset you want to export, then tap the 'manage' button. Tap 'export selected preset', then tap the media where you want to export the preset. If a preset with the same name is already present, choose whether to overwrite the preset or keep both. The camera exports the preset to a 'Presets' folder.

Deleting presets

To delete a preset, select it and tap the 'delete' icon. When you are prompted to confirm your choice, tap 'delete'.

3D LUTs

The 'LUTS' menu lets you import, export and apply 3D LUTs to your camera's outputs.

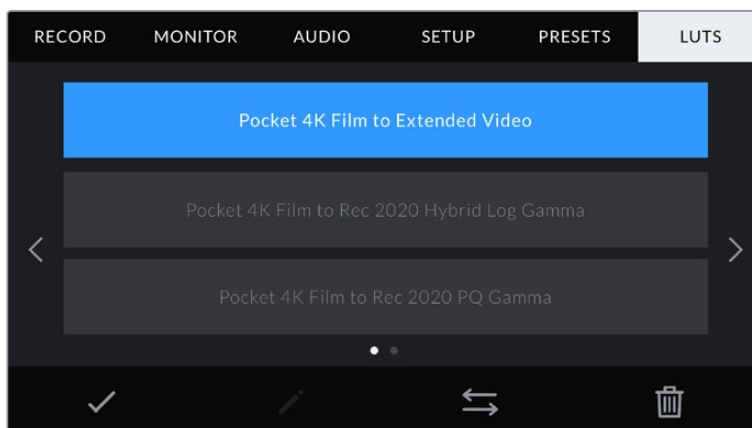

Select a 3D LUT using your camera's LUTS tab

Introducing 3D LUTs

3D LUTs can be applied to images on your camera's LCD touchscreen and HDMI output. LUTs work by telling your camera what color and luminance output to show for a particular color and luminance input. For example, a LUT may tell your camera to display a vibrant, saturated blue

when it receives a relatively dull blue input. This can be useful when shooting Blackmagic RAW footage, or using 'film' dynamic range, both of which have an intentionally undersaturated, 'flat' appearance. By applying a LUT, you can get an idea of what your footage will look like after it has been graded.

It is easy to create 3D LUTs using DaVinci Resolve or other color correction software, and LUTs are available online from a variety of sources. Up to 10 17 point or 33 point 3D LUTs up to 1.5 megabytes each can be stored on the camera. Once loaded, you can choose to display a given LUT on your camera's LCD touchscreen and HDMI output.

Your Blackmagic Pocket Cinema Camera supports 33 point 3D LUTs in .cube format created in DaVinci Resolve and 17 point 3D LUTs converted to Resolve .cube format via LUT conversion programs. Your camera processes 3D LUTs using high quality tetrahedral interpolation.

TIP For more information on displaying LUTs, see the 'monitor settings' section in this manual.

NOTE Your Blackmagic Pocket Cinema Camera does not apply, or 'bake in,' LUTs by default to recorded footage, however you can choose to 'bake in' the LUT to your footage.

This can be a useful option for situations where you do not have the time to grade your footage in post-production, or where you need to give the footage directly to a client or an editor.

When you are using LUTs as a preview tool on set, the information on the LUT applied is saved as metadata with your recordings. DaVinci Resolve can display this information in the 'LUT used' field in the metadata tab, which can be helpful for colorists to verify the name of the LUT that was used on set.

Built-in LUTs

A number of built in LUTs are provided that allow you to preview different looks when shooting in 'film' dynamic range or Blackmagic RAW.

Each camera provides LUTs that are specific to the sensor:

Pocket 4K Film to Extended Video / Pocket 6K Film to Extended Video

Displays a wider dynamic range than the 'Pocket 4K Film to Video' or 'Pocket 6K Film to Video' LUT, and applies a mild contrast change with a smooth roll off in the highlights.

Pocket 4K Film to Rec 2020 Hybrid Log Gamma / Pocket 6K Film to Rec 2020 Hybrid Log Gamma

Displays a hybrid between REC 709 and a log image.

Pocket 4K Film to Rec 2020 PQ Gamma / Pocket 6K Film to Rec 2020 PQ Gamma

Displays a gamma curve that is based on what we can perceive with our eyes, for efficient encoding of HDR images.

Pocket 4K Film to Video / Pocket 6K Film to Video

Similar to the REC 709 color standard for high definition video, and has a high level of contrast and saturation. You may find this setting useful when using Blackmagic Pocket Cinema Camera alongside other broadcast cameras using the REC 709 color space.

LUTs buttons

The button icons along the bottom of your camera's 'LUTS' screen correspond to the following functions:

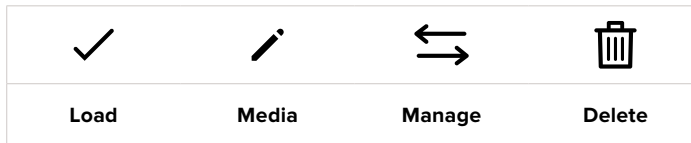

Importing LUTs

To import a 3D LUT, tap the 'manage' icon at the bottom of the 'LUTs' menu. Tap 'import LUT', then tap 'import' to confirm. This brings up the LUT import screen. If your preferred 3D LUT is not on the active card or drive, switch between recording media by tapping a media button at the top of the touchscreen. You can import LUTs from a USB-C flash disk, CFast or SD card.

Your camera searches the root directory and '3DLUTs' folder on your selected media, and lists available LUTs. Any LUTs you have saved elsewhere are not visible.

Tap a LUT to select it, then tap 'import' to confirm your selection and copy it to the next available slot on the camera.

NOTE If you want to import a new LUT but all 10 3D LUT slots are full, you need to delete an existing LUT to make space.

If the LUT you want to import has the same name as a LUT already saved to your camera, you can choose to overwrite the existing LUT or keep both. At the top right of this screen, you'll see the number of remaining empty LUT slots available on your camera. You are able to import as many LUTs as you have free slots on your camera.

NOTE If you have trouble importing a LUT, it may be the wrong size. You can use a LUT editor like Lattice to check its size, or open it in any text editor on your computer. Next to the tag 'LUT_3D_SIZE' is a number indicating the LUT's size. If this value is not 17 or 33, you can use Lattice to resize your 3D LUT to 17 points.

Applying a LUT

Once you have a LUT saved onto your camera, tap it in the LUT menu to select it, and tap the 'load' icon. This enables the LUT for all outputs on your camera. To display the loaded LUT on your camera outputs, switch on 'display LUT' in the monitor menu. See the 'monitor settings' section for more information.

Exporting LUTs

To export a LUT to a card or USB-C flash disk, tap the LUT you want to export, then tap the 'manage' button. Tap 'export selected LUT', then tap the media where you want to export the LUT. If a LUT with the same name is already present, choose whether to overwrite the LUT or keep both. The camera exports the LUT to a '3DLUTs' folder.

Deleting LUTs

To delete LUTs you are no longer using or make room for more, select the LUTs you want to delete and tap the delete icon. When you are prompted to confirm your choice, tap 'delete'.

Embedded 3D LUTs

When a 3D LUT is used while shooting Blackmagic RAW on Blackmagic Pocket Cinema Camera, the selected LUT will be embedded into the Blackmagic RAW file that you are recording. The 3D LUT is actually saved with your recorded files in the header of the .braw file, and can easily be applied to footage in post production without needing to handle a separate file.

So when Blackmagic RAW files are delivered to an editor or colorist, they will be able to easily access the LUT that was used while filming, which greatly reduces the possibility that the wrong 3D LUT could be applied to a clip. They can then choose whether to apply the 3D LUT when editing or color grading the footage, and can disable the 3D LUT at any time.

When the 'apply LUT in file' switch is set to 'on' in the record menu, the recorded clip will open in Blackmagic RAW Player and DaVinci Resolve with the chosen 3D LUT already applied to it.

The 3D LUT can then be easily toggled 'on' or 'off' but will always travel with the Blackmagic RAW file as it is written into the clip itself. DaVinci Resolve also has an 'Apply LUT' switch in the RAW settings palette for enabling or disabling the 3D LUT in the Blackmagic RAW file.

The 'Apply LUT' setting in DaVinci Resolve is the same setting as in the camera. This means that when shooting you can direct the colorist to use the LUT by setting it in the camera, but they can switch it off easily in DaVinci Resolve by setting 'Apply LUT' to 'off'.

Entering Metadata

Metadata is information saved inside your clip, such as take numbers, camera settings and other identifying details. This is extremely useful when sorting and processing footage in post production. For example, take, shot and scene numbers are essential organisational tools, while lens information can be used to automatically remove distortion or better match VFX assets to plates.

Your Blackmagic Pocket Cinema Camera automatically saves some metadata to each clip, such as camera settings, timecode, date and time. You can use your camera's slate to add many additional details.

Slate

Swipe left or right on your camera's touchscreen from the main view to bring up the slate.

The slate is divided into 'clip' and 'project' tabs. The 'clip' tab contains information that may vary clip by clip, while 'project' is where you enter details common between clips, such as the project name, director, and camera and operator ID.

TIP Metadata entered into the slate is viewable on the HDMI output when set to 'director view.' See the 'monitor settings' section in this manual for more information.

'Clip' metadata

Making changes to clip metadata works differently in standby mode to playback mode. In standby mode, when your camera is ready to record, clip metadata gets saved to the next clip recorded, except the 'good take last clip' button applies a 'good take' tag to the most recently recorded clip. In 'playback' mode, when you are reviewing footage already shot, the 'good take' button is shown and clip metadata is always attached to the current clip being viewed.

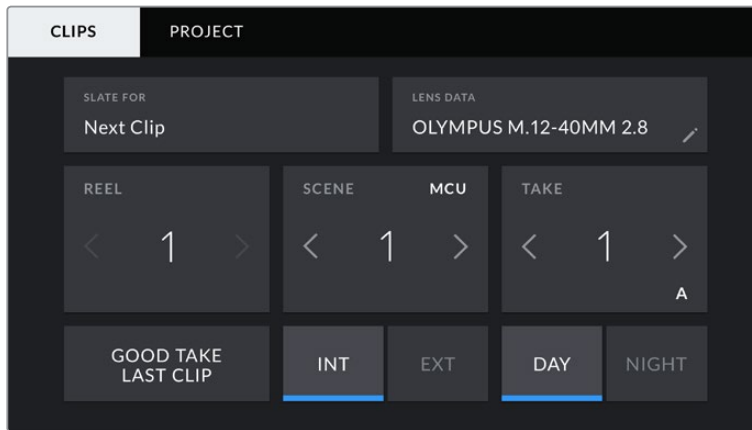

When the camera is in playback mode, 'slate for' identifies the clip the slate applies to and shows the 'good take' button. In standby mode, the slate is for 'next clip' and shows the 'good take last clip' button.

Slate for

This setting shows the clip which the metadata currently displayed in the 'clip' applies to. In 'playback' mode it applies to the current clip, and in 'standby' mode it refers to the next clip you record.

Lens Data

These settings display information about the current lens fitted to your camera. Many electronic lenses automatically supply information such as the lens model, aperture and focal length. If you are using a lens that does not provide this information, or you want to enter additional data, you can tap the pencil icon in this setting to enter the information manually. This will bring up the 'lens data' menu, which contains the following information:

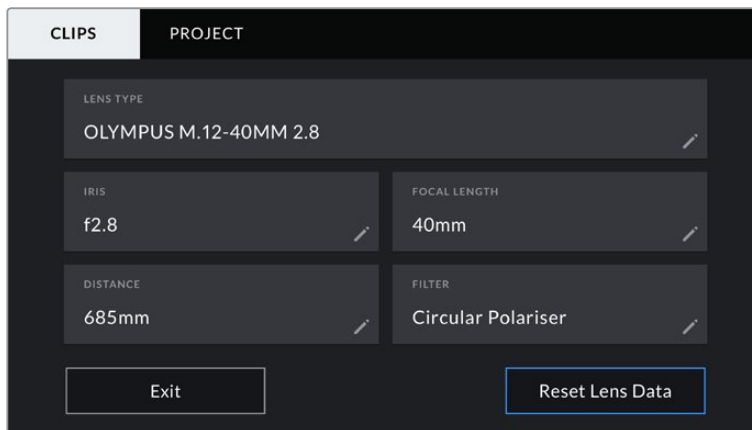

The 'lens data' menu showing information automatically populated from an attached lens, and filter information that has been manually entered

• Lens Type

Shows the lens model. If your lens type is not automatically shown here, you can tap this setting to enter the data manually. Your camera has an internal database stored for many commonly used lenses, so if you need to enter data manually, your camera will suggest names automatically as you type. This makes entering data much faster.

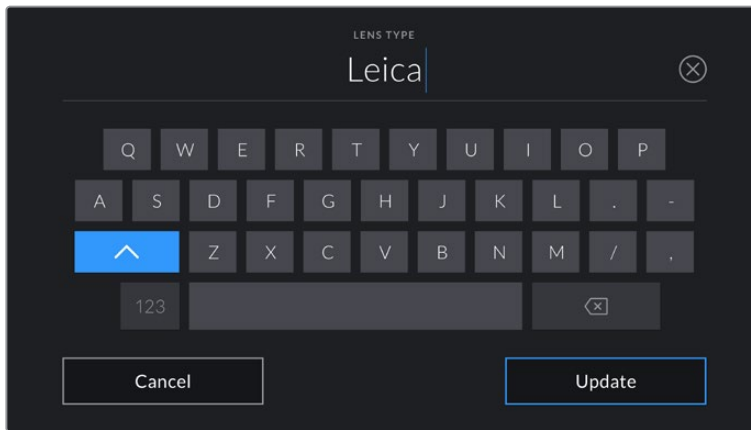

Use the touch keyboard to enter lens data if it is not provided automatically

- **Iris**

Shows the iris aperture setting at the start of your clip. This information can be displayed in f- or T-stops depending on the lens used, if supplied automatically. Tap this setting to enter data manually.
- **Focal length**

Shows the focal length setting of the lens at the start of the recorded clip. When automatically supplied, this is shown in millimeters. Tap this setting to enter the focal length manually.
- **Distance**

Shows the focus distance settings of the lens for the recorded clip. Some lenses can provide this data automatically and it will be provided in millimeters. You can also enter this data manually.
- **Filter**

Shows the current lens filters used. Tap this setting to enter data manually. You can make multiple entries separated by commas.

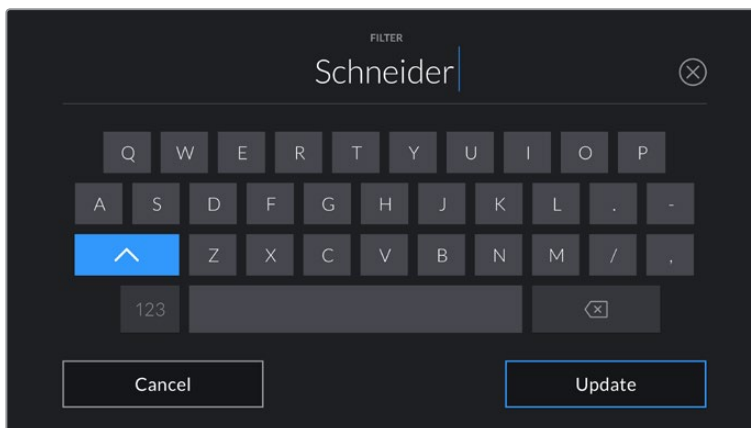

Filter information needs to be entered manually

NOTE You can clear lens data at any time by tapping the 'reset lens data' icon in the 'lens data' menu. You will be prompted to confirm your choice. If you confirm, all lens data will be cleared and repopulated with any lens data automatically provided by the currently fitted lens. If you have manually entered any information into these fields, you will need to reset the lens data the next time you mount a lens, otherwise the manually entered value will remain.

Reel

Displays the current reel.

Your Blackmagic Pocket Cinema Camera automatically increments reel numbers, so there is usually no need to enter this manually. When you are moving to a new project and want to start from reel '1' again go into the project tab of the slate and tap 'reset project data'.

Scene

The 'scene' indicator shows the current scene number, and can also show the current shot number and type.

The number on this indicator always refers to the current scene. You can adjust it with the left and right arrows on either side of the scene number, or tap the scene number to enter the scene number editor.

Scene numbers range from 1 to 9999.

By adding a letter to the scene number in the scene number editor, you can also indicate the current shot. For example 23A indicates scene twenty three, shot one. If you have a shot letter added to your scene number, your camera suggests the next scene number and shot letter whenever you enter the scene number editor. For example, if your current scene number is 7B, the camera suggests '8' and '7C'.

The scene number indicator can also show information about the current shot type in the top right corner. You can select these in the scene number editor at the right hand side of the shot keyboard.

The shot types available are:

| | |
|------------|------------------|
| WS | wide shot |
| MS | medium shot |
| MCU | medium close up |
| CU | close up |
| BCU | big close up |
| ECU | extreme close up |

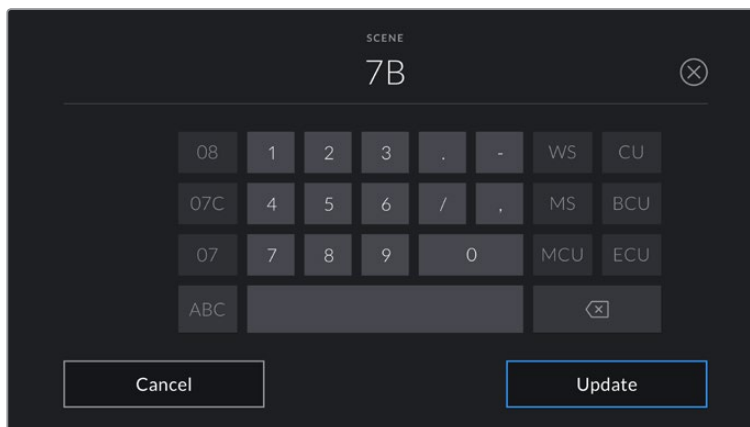

When entering 'scene' metadata, the camera prompts you with scene number suggestions to the left of the touch keyboard, and shot types to the right

Take

The 'take' indicator shows the take number for the current shot. You can adjust it by tapping the left or right arrows on either side of the take number, or tapping the indicator to enter the take number editor.

TIP When the shot number or scene letter advance the take number reverts to '1.'

You can add descriptions in the take number editor. These are on the right of the take number keyboard and correspond to the following scenarios:

P/U 'Pick up.' This refers to a reshoot of a previous take to add additional material after principal photography has wrapped.

VFX 'Visual effects.' This refers to a take or shot for visual effect use.

SER 'Series.' This refers to a situation in which multiple takes are shot while the camera is kept running.

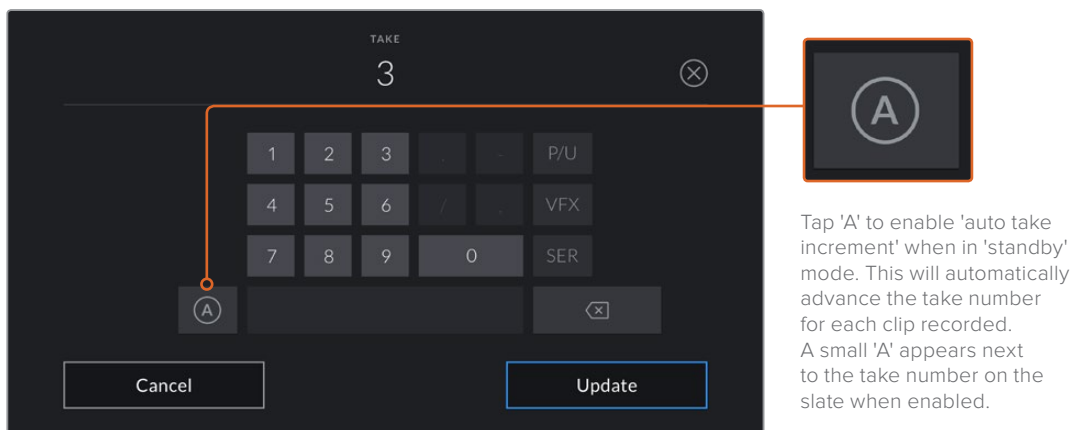

When entering 'take' metadata, your Blackmagic Pocket Cinema Camera will offer prompts for additional shot types to the right of the touch keyboard

Good take

Tap the 'good take' indicator to tag good takes for easy recall in post production. This button applies the 'good take' tag to the clip currently being viewed in 'playback' mode. If the camera is in 'standby' mode and ready to record, the 'good take last clip' button applies a 'good take' tag to the last clip recorded.

Int / Ext

Tap 'int' or 'ext' to add a 'interior' or 'exterior' tag to the next clip in standby mode, or the current clip in playback mode.

Day / Night

Tap the 'day' or 'night' icons to add a 'day' or 'night' tag to the next clip in standby mode, or the current clip in playback mode.

‘Project’ Metadata

Project metadata behaves the same way whether you are in ‘standby’ or ‘playback’ mode. This metadata always refers to your project as a whole and is independent of clip numbers.

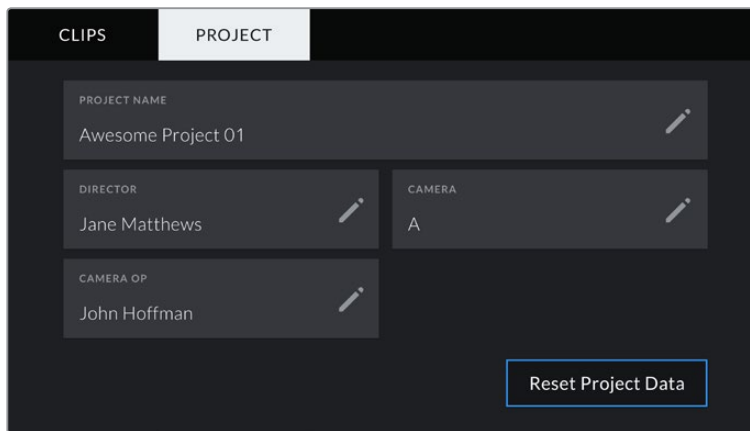

Enter project details using your camera's 'project' slate tab

Project name

Displays your current project name. Tap the pencil icon to change the project name.

Director

Displays the director's name for the current project. Tap the pencil icon to change the director name.

Camera

Displays a single letter camera index. Tap the pencil icon to change the camera index.

Camera Op

Displays the camera operator. Tap the pencil icon to change the camera operator name.

Camera Video Output

HD Monitoring Output

The camera's full size HDMI connector outputs 1080p HD video so you can easily connect to monitors or even consumer television sets to preview your images. This 10-bit output also supports HDR and on screen overlays showing full camera status, making it perfect for on set monitoring.

HDMI monitoring can be helpful when accessing the LCD is impractical, such as when the camera is secured high on a jib arm, on a crane, or mounted on a vehicle. Monitoring information is displayed on your HDMI output by adjusting the HDMI overlays options in the display settings menu. HDMI overlays provide frame guides and information such as recording details and camera settings. If you simply want to monitor your shots, you can always turn overlays off for a clean HDMI output.

By using a converter like the Blackmagic Micro Converter HDMI to SDI, you can convert the signal to SDI, allowing you to connect to SDI monitors, capture devices, broadcast switchers and other SDI devices. You can even power the Blackmagic Micro Converter HDMI to SDI via your Blackmagic Pocket Cinema Camera's USB port.

Using DaVinci Resolve

Shooting with your Blackmagic Pocket Cinema Camera is only part of the process of creating film and television content, and just as important is the process of media backup and management as well as editing, color correction and encoding final master files. Your Pocket Cinema Camera includes a version of DaVinci Resolve for macOS and Windows so you have a complete solution for shooting and post production!

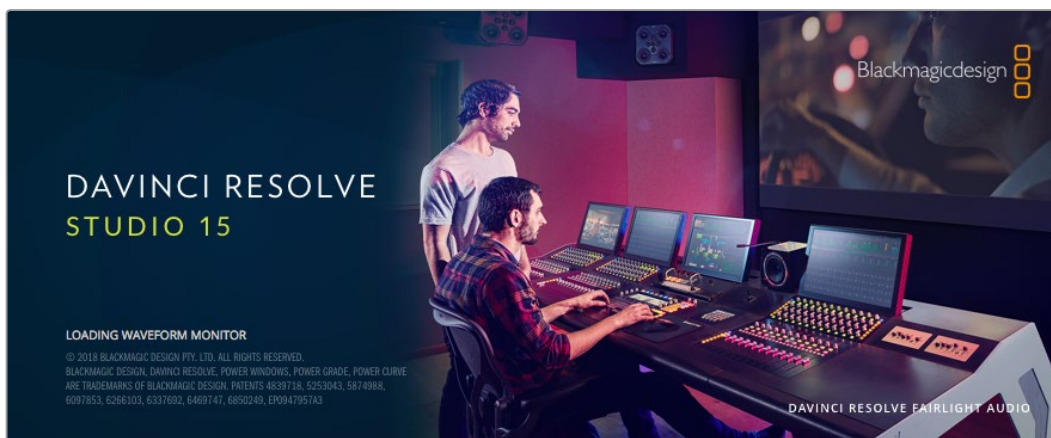

NOTE We recommend using the latest version of DaVinci Resolve for accurate color treatment of clips shot using Blackmagic Pocket Cinema Camera. Version 15.2 or later will provide accurate color for all Blackmagic cameras and the latest Blackmagic RAW features.

After connecting your CFast, SD Card or SSD to your computer, you can use DaVinci Resolve's 'clone' tool, in the 'media' page, to create running backups as you shoot. This is recommended as any type of media is susceptible to becoming damaged or developing a fault so creating backups means your shots will be immune to loss. Once you have used DaVinci Resolve to backup your media, you can then add your clips to the DaVinci media pool, then edit, color correct, and finish your production without ever having to leave DaVinci Resolve.

DaVinci Resolve is the same tool used on most major blockbuster movies, so it's much more than a simple NLE software tool, as it has extremely advanced technology built in for high end digital film. You get the advantage of this technology when you use DaVinci Resolve to edit and color correct your work.

Included here is information on how to get started using DaVinci Resolve with your camera files. Of course, DaVinci Resolve is extremely advanced and includes a lot more features than you immediately see when first looking at its user interface. To learn more about how to use DaVinci Resolve, please check for the DaVinci Resolve instruction manual pdf file on the DaVinci Resolve software disk, or check online for the many training courses and tutorial videos available.

Importing your Clips

To start editing your clips, you'll first need to import them into the media pool:

- 1 Launch DaVinci Resolve. If this is the first time you've opened DaVinci Resolve, wait for the Project Manager to appear.
Now click 'new project', enter a title for your project and click 'create'. Your new project will open.
- 2 You'll now see the 'media' page with a 'media storage' browser at the top left. If you're not on the media page, simply click the Media tab at the bottom. The 'media storage' browser displays all your linked media folders from where you'll drag your clips and drop them into the media pool.
- 3 If your clip folder doesn't appear in the library, you'll need to add it. This is easily done by right clicking inside the 'media storage' browser area, clicking 'add new location', then selecting a drive or folder path and clicking 'open'.
- 4 In the 'media storage' browser, click on your newly added clip folder. Now simply drag your clips from your storage folder and drop them into the media pool underneath. If the project settings are different to your clip settings, you'll be prompted to either change the project settings to match your clips, or leave the settings as they are. To get started quickly, click 'change'. Now your project settings match your clips.



To import your clips, simply drag them from the 'media storage' browser and drop them into the media pool. You can also drag and drop files from your desktop

Saving Your Project

DaVinci Resolve features powerful options for saving your projects. First save your project by choosing 'save project' from the file menu. Once you've saved your project once, 'live save', a fast, on the go autosave mechanism, will save your changes as you make them.

For greater control over your project backups, open the Resolve preferences panel and click the user tab. Select 'project save and load' from the side menu and turn on 'project backups'. Here you can choose how often you will save versions of your project and how long you will keep the backups for. You can also choose where to save your backups. This is great for when you want to roll back to an earlier version of your project. For more detail on the auto save options, refer to the DaVinci Resolve manual.

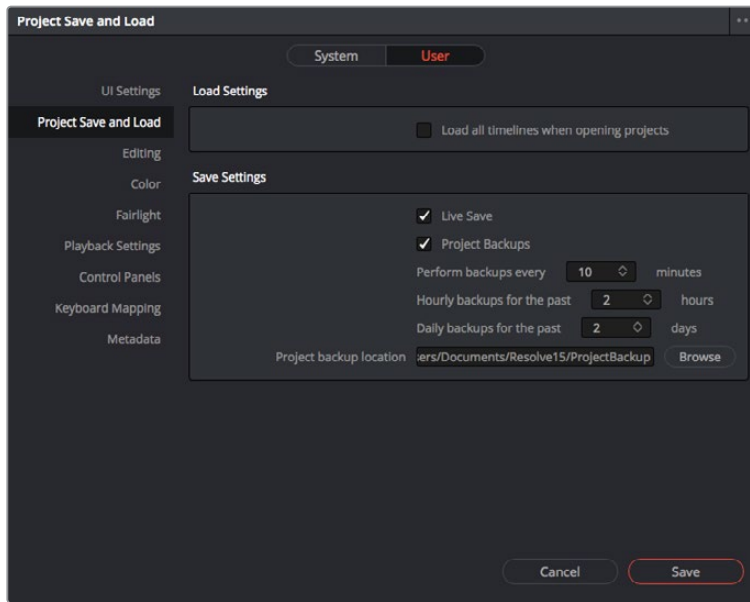

Working with Blackmagic RAW Files

Blackmagic RAW clips give you maximum flexibility in post production. This lets you make adjustments to clips, such as white balance and ISO settings, as if you were changing the original camera settings. Working with Blackmagic RAW also retains more tonal information within shadows and highlights, which is useful for recovering details, for example in blown out skies and dark areas of the picture.

It's worth shooting in Blackmagic RAW if you are after the highest possible quality, or for shots where there is an extreme variance between highlights and shadows and you may need to push and pull those regions as much as possible in the grade.

The speed and small file size of Blackmagic RAW means you don't need to make proxy files and playback is just like a standard video clip. This section of the manual describes the features of Blackmagic RAW and how to use Blackmagic RAW files in your DaVinci Resolve workflow.

About Blackmagic RAW

When shooting Blackmagic RAW on Blackmagic Pocket Cinema Camera, part of the RAW processing is removed from the software and calculated real time in camera. This improves the post production process with faster transfer speeds, smaller file sizes and better read speeds. Blackmagic RAW is an intelligent format, understanding the characteristics of your camera and sensor. In addition to the other metadata your camera files contain, DaVinci Resolve can read your selected dynamic range so your clips will automatically display in DaVinci Resolve with 'film', 'extended video' or 'video'.

If you have selected 'film' or 'extended video' as your dynamic range in camera, you can customize these settings by adjusting the saturation, contrast and midpoint, as well as the highlight and shadow rolloff. Any adjustments can then be saved as a sidecar file, so the changes can be seen by anyone else working with the files in post. You can always return to the original camera metadata at any time.

This also means you can copy your media for another DaVinci Resolve user and they will have access to your modified gamma settings automatically on import.

Clip Settings for Blackmagic RAW

When you first import Blackmagic RAW files, DaVinci Resolve will decode the camera data contained in the files using the ISO, white balance and tint settings used at the time of shooting. If you're happy with the look of these settings, you can start editing right away.

The great thing about shooting Blackmagic RAW is that you're not tied to these settings at all! The breadth of available post processing options when working with Blackmagic RAW files mean that you'll develop your own workflow over time. Experimenting with the 'clip' settings for each clip in the 'camera raw' tab will show you just how powerful and flexible working with Blackmagic RAW can be.

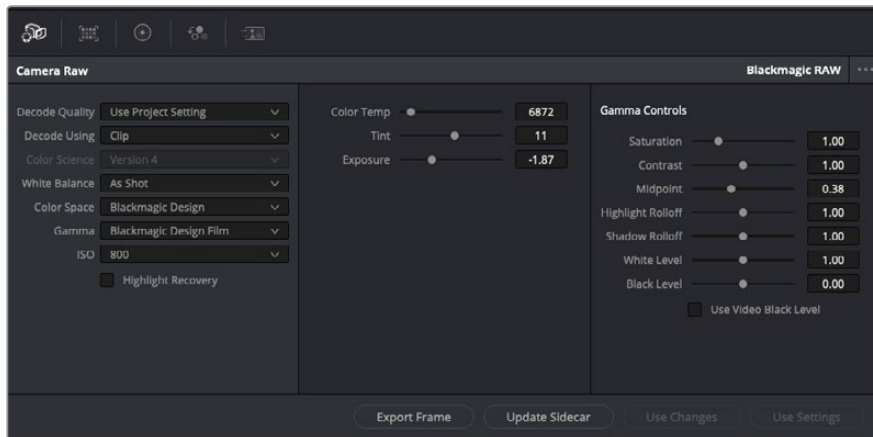

In the 'camera raw' tab, select 'clip' from the 'decode using' drop down menu to make adjustments to your clip's Blackmagic RAW settings

Once you have set DaVinci to enable clip settings for Blackmagic RAW, the clip settings and gamma controls are now adjustable. Adjusting these settings to optimize your clips can bring them close to a full primaries grade. This is especially powerful when using DaVinci Resolve's scopes which can help you neutralize and balance the clips ready for applying a look.

The following information contains descriptions for the clip and gamma controls.

ISO

The ISO value can be changed by increasing or decreasing this setting. This setting is helpful if you need to set the clip to a brighter or darker starting point for optimization.

Highlight Recovery

Check the box to reconstruct highlight information in clipped channels using information from non-clipped channels.

Color Temp

Adjust the color temperature to warm or cool the image. This can be used to help neutralize the color balance in each image.

Tint

Adjusting this setting will add green or magenta into the image to help balance the color.

Exposure

Use this setting to refine the overall brightness of the image.

Saturation

Saturation controls default at 1 and range from -1 for the minimum saturation to +4 for maximum saturation.

Contrast

Defaulting at 1.0, drag the slider to the left for the least amount of contrast at 0 or to the right to increase the contrast up to 2.

Midpoint

In Blackmagic Design Film, your middle gray value defaults to 0.38, or 38.4%. Drag the slider to the left to lower your midpoint or to the right to raise it to 100. When contrast is adjusted away from the default setting, you can modify your highlight and shadow rolloff.

Highlight Rolloff

Adjust the highlights by dragging the slider to the left to lower the value to 0, or to the right to increase the highlights to 2. The default value is 1.

Shadow Rolloff

Drag the slider to the left to lower your shadows to 0 or to the right to raise your shadows to 2.

White Level

Adjust the white point of the gamma curve by dragging the slider from the highest value of 2 to the lowest value of 0. The default value is 1.

Black Level

Raise the black point of the custom gamma curve by dragging the slider to the right from the lowest value of -1 to a maximum of 1. The default value is 0.

Use Video Black Level

Check the box to set your black levels to video.

Export Frame

Clicking the 'export frame' button lets you export a single frame from your Blackmagic RAW clip.

Update Sidecar

Click this button to update the Blackmagic RAW sidecar file for the current clip.

Any changes you have made to your Blackmagic RAW clips will be identified by the gamma setting changing to Blackmagic Design Custom.

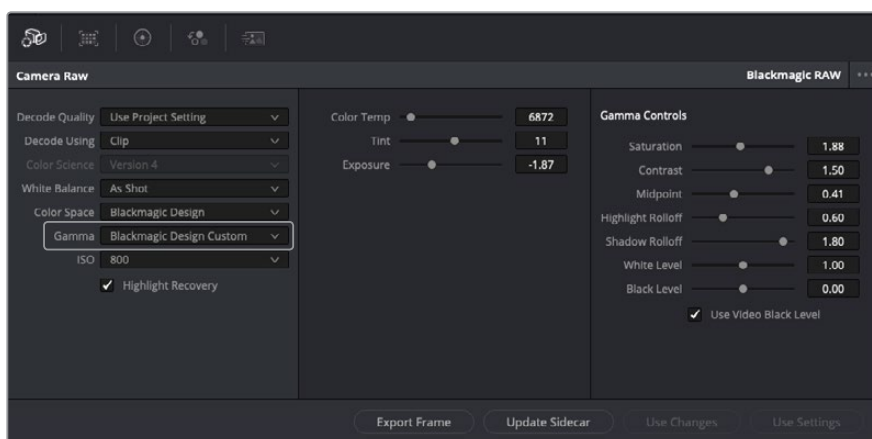

If you want to revert your clip to one of the default gamma options available, simply select it from the gamma dropdown menu.

TIP Gamma controls are disabled for footage shot with the 'video' dynamic range, but you have not lost your Blackmagic RAW data. Simply select Blackmagic Design Film or Blackmagic Design Extended Video from the dropdown gamma menu and make your adjustments.

Saving your Blackmagic RAW changes

- 1 Adjust the gamma controls for your Blackmagic RAW clip.
- 2 Click the 'update sidecar' button.

A 'sidecar' file will now be created in the same folder as your .braw file. When another user imports the Blackmagic RAW files, the sidecar files will automatically be read by DaVinci Resolve. If you make additional adjustments, press 'update sidecar' again.

TIP To remove your sidecar file, you can simply delete it from its location on your media drive.

Project Settings for Blackmagic RAW

If you need to make a setting change that is common to all the clips, for example a global change to the white balance or ISO setting, you can set the clips to use the project 'camera raw' settings and make global changes from there.

To set project settings for Blackmagic RAW:

- 1 Enter the project settings menu by clicking 'file,' and selecting 'project settings.'
- 2 In the 'Camera RAW' tab, you'll see a dropdown menu next to RAW profile. Click on the arrow to select Blackmagic RAW from the list.
- 3 Select 'project' in the 'Decode Using' dropdown menu.
- 4 Set the white balance setting to 'custom'.
- 5 Select 'Blackmagic Design Custom' from the dropdown gamma menu. Set the color space to 'Blackmagic Design'. This will also set the gamma setting to 'Blackmagic Design Film'.
- 6 Choose your resolution from the 'Decode Quality' menu. A lower resolution will give you better playback on limited systems. You also have the flexibility to change to full resolution later on before delivery for the highest quality output.

Now you can adjust the camera settings for your clips such as saturation, contrast and midpoint. This will affect all clips in your project that are set to decode using 'project'.

Editing your Clips

With your clips in the media pool, click on the 'edit' tab to open the edit page.

Now you can start building your edit!

- 1 You'll first need to create a new timeline. Right click on an empty area within the media pool and choose Timelines > Create New Timeline. When the dialog box appears, name your timeline and click the 'create' button.

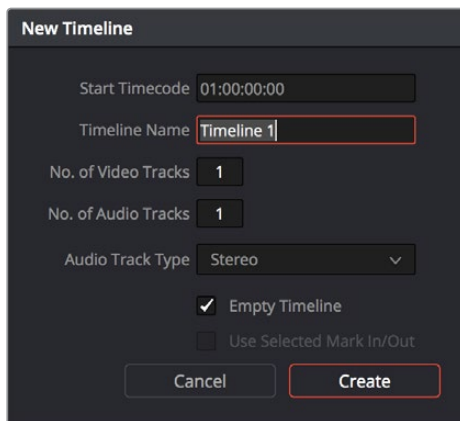

To start editing your clips, you'll need to create a new timeline. The timeline is the stage upon which all your editing will take place

- 2 Double click a clip in the media pool to open the clip in the source viewer. Use the mouse pointer to scrub the play head under the source viewer left and right until you find the start frame you want for the clip. Mark the in point with the 'I' keyboard shortcut. Do the same for the end frame using the 'O' keyboard shortcut.
- 3 Go to the timeline and position the timeline play head where you want your clip to be inserted.
- 4 To insert the clip onto the timeline, click inside the source viewer then drag the mouse pointer across to the right hand side of the timeline viewer. A list of edit options will appear. Select insert.

Your clip will be placed onto the timeline using the edit type you selected. You'll find a description of each edit type and how to use them in the DaVinci Resolve manual.

A faster way to add clips to your edit is by dragging them from the media pool and dropping them directly onto the timeline where you can adjust your in and out points, position your clips, try different plug in effects, titles, and more. This particular workflow is like using the timeline as an artist's palette.

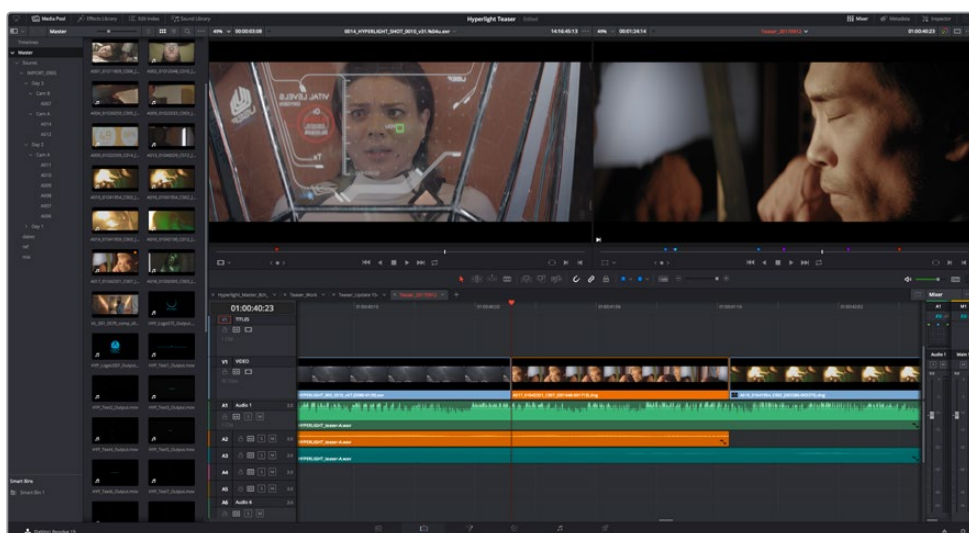

The 'edit' page. You can trim your clips, change their order, move them around and add transitions between them using the timeline editor

Trimming Clips

You can refine your edits to include only the specific frames you want in each shot by using the trim tools. There are various ways, but the easiest is to adjust the clips' in and out points on the timeline:

- 1 After adding clips to your timeline, hover your mouse pointer over the start of a clip until the pointer becomes a 'trim' icon, a single bracket with arrow.
- 2 When the 'trim' icon appears, click on the start of your clip and drag it forwards or backwards to trim the in point. Watch the timeline viewer on the right as you trim to find the edit point.
- 3 Now click and drag the end of your clip to adjust the out point.

The zoom slider is located above the timeline, to the right of the tools that are centered in the toolbar. By dragging the slider left and right you can zoom in and out of your timeline to make fine adjustments.

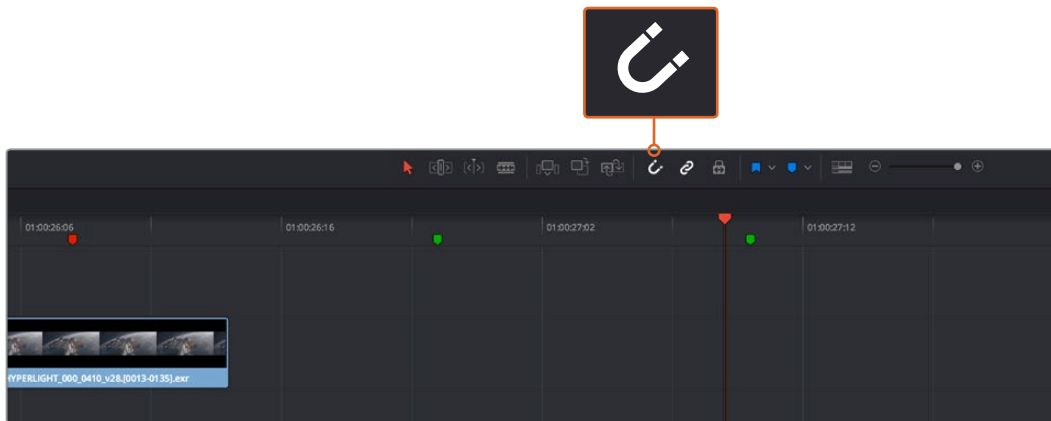

Trim your clips by dragging their start and end points left or right, and press the 'snapping' button in the toolbar to turn snapping on or off

Snapping is a helpful feature to use when adding clips to a timeline, or when moving clips around, as they will "snap" together at edit points so you don't overlap or leave blank space between clips. Snapping can be disabled for greater precision when fine tuning edits. Press the 'N' key to quickly turn snapping on or off.

Adding Transitions

A transition is a video or audio effect used to bridge one clip to another in a pleasing way, for example dissolves, wipes, dips to color, cross fades and more. These can add a layer of excitement to your edit. Transitions don't always have to be joining two clips, for example you can apply a dissolve transition to the end of one clip to create a quick and easy fade to black.

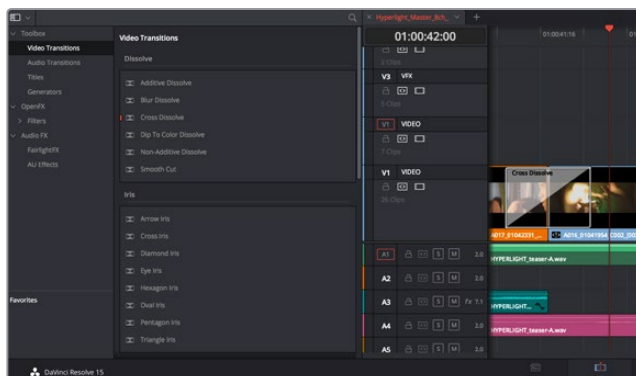

The transitions palette contains many types of transition effects

To add a dissolve transition between two clips:

- 1 Make sure there are two clips edited right next to one another on the timeline. Click the 'effects library' button in the UI toolbar at the top of the 'edit' page, and make sure the 'toolbox' panel is expanded.
- 2 Click on the 'cross dissolve' transition, drag it to your timeline and hover it over the edit point between two clips. You'll see the mouse pointer highlight both the end section of the first clip, and the start of the second. Drop the transition onto the clips. Most transitions are 1 second in length by default. If you don't have enough duration before and after the clips edit points, the transition length will reduce to what frames are available.

You now have a smooth transition mixing from one clip to the other. If you want to adjust the length of the transition you can lengthen or shorten its start and end point using a similar approach to trimming a clip. Hover your mouse pointer over the start or end of the transition until the transition 'trim' icon appears, then drag it left or right.

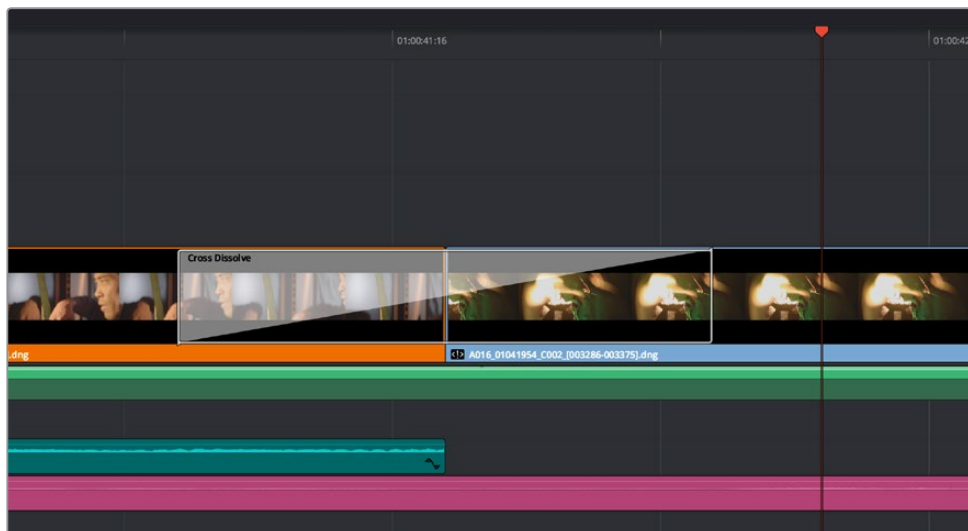

Simply drag and drop transitions between adjoining clips

Adding Titles

You can place a title on any video track just as you would a clip. If you run out of tracks you can easily add new ones by right clicking next to an existing track name and selecting 'add track'.

To create a title:

- 1 Click on 'titles' underneath the toolbox in the 'effects library'. If the 'media pool' is open, you will need to use the scroll bar to reveal more 'titles' options.
- 2 Drag and drop a 'text' title on the empty video track above the clip you want the title to appear. You can even drop your title next to a clip on Video 1 if you just want it to appear over black. To see the title, make sure the timeline playhead is on the title.
- 3 Double click on the title clip. The 'inspector' will appear showing you the settings for your title. Type your title into the 'text' field.

You can choose from a variety of fonts and adjust the appearance of your title by changing settings such as color, size, alignment, position, and more. Transitions can be added to titles, just like they can for clips.



Drag a title type from the 'titles' palette and drop it on an empty track

Color Correcting your Clips

Once you have edited your sequence of clips and added your vfx, you can start color correcting. This is best begun after you have finished editing your sequence so you can maintain a consistent look, but part of the fun of DaVinci Resolve is being able to move between the edit, fusion and color pages to make fine adjustments and discover new creative choices.

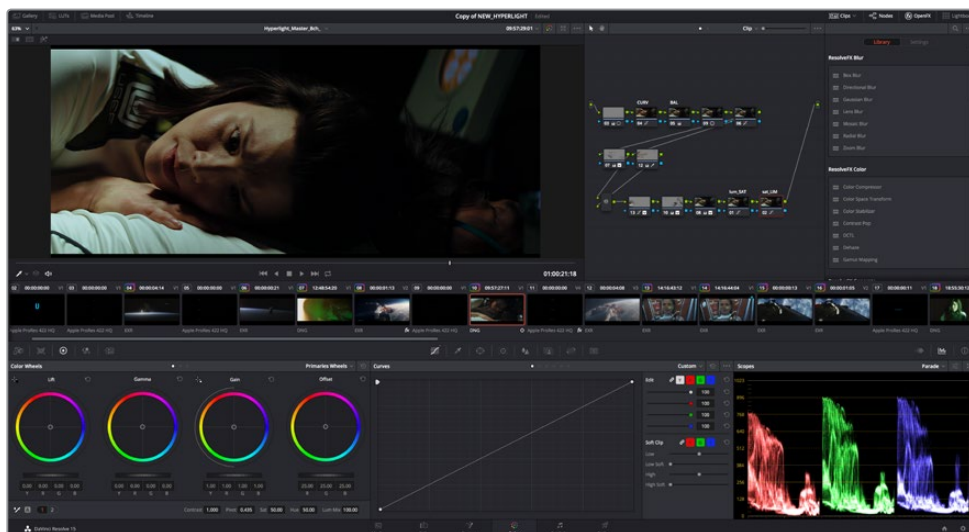

With the 'color' page you get absolute control over the look of your clips

First, click on the 'color' tab to open the 'color' page.

You'll see the color wheels, curves palettes and general color correction tools as well as the preview and nodes window. Don't feel overwhelmed by the vast array of features in front of you, they are all there to help you get the most amazing looking pictures. The DaVinci Resolve manual will show you exactly what the tools are for and how to use them in easy to follow steps. You'll learn the same techniques the professionals use in high end color correction facilities.

Generally, the first thing you'll want to do is optimize the shadows, mid tones and highlights in your clips. In other words adjust the 'lift', 'gamma' and 'gain' settings. This will help get your pictures looking their brightest and best with a clean, balanced starting point from where you can begin grading the 'look' of your film.

Using Scopes

Most colorists make creative color choices by focusing on the emotion and the look they want their program to have and then simply work using the monitor to achieve that look. You can look at everyday objects and how different types of light interact with them to generate ideas on what you can do with your images and a little practice.

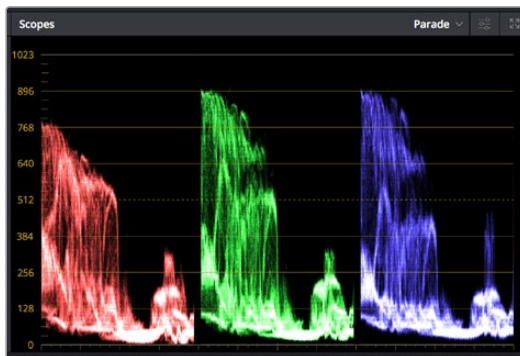

The parade scope helps you optimize highlights, mid tones and shadows



The 'lift', 'gamma', 'gain' and 'offset' color wheels give you total control over the color and tonal balance of your clips. To make a uniform adjustment to all colors for each tonal region, drag the dial underneath the color wheels back and forth

Another way to color grade is to use the built in scopes to help you balance shots. You can open a single video scope by clicking the 'scope' button, which is the second from the right on the palette toolbar. You can choose to display a waveform, parade, vectorscope and histogram. Using these scopes you can monitor your tonal balance, check the levels of your video to avoid crushing your blacks and clipping the highlights, plus monitor any color cast in your clips.

The 'color wheels' palette contains the 'lift', 'gamma' and 'gain' controls which will generally constitute your first adjustment. If you've previously had experience with color correction, these should resemble controls you've seen in other applications for doing color and contrast adjustments. For more accurate control of each color using a mouse, you can change the color wheels to 'primaries bars' which let you adjust each color and luminance channel for the lift,

gamma and gain controls separately. Simply select 'primaries bars' from the dropdown menu near the top right of the color wheels.

1 Adjusting the 'lift'

With your clip selected on the color timeline, click on the 'lift' dial underneath the first color wheel. Slide it back and forth and watch how it affects your image. You'll see the brightness of the dark regions of your picture increase and decrease.

Set it to where you want the dark areas to look their best. If you decrease the lift too much, you'll lose details in the blacks and you can use the parade scope to help avoid this. The optimal position for blacks on the waveform is just above the bottom line of the parade scope.

2 Adjusting the 'gain'

Click on the 'gain' dial and slide it back and forth. This adjusts the highlights which are the brightest areas of your clip. The highlights are shown on the top section of the waveform on the parade scope. For a brightly lit shot, these are best positioned just below the top line of the waveform scope. If the highlights rise above the top line of the waveform scope, they will clip and you will lose details in the brightest regions of your image.

3 Adjusting the 'gamma'

Click on the 'gamma' dial underneath the color wheel and slide it back and forth. As you increase the gamma you'll see the brightness of the image increase. Notice the middle section of the waveform will also move as you adjust the gamma. This represents the mid tones of your clip. The optimal position for mid tones generally falls between 50 to 70% on the waveform scope. However, this can be subjective based on the look you are creating and the lighting conditions in the clip.

You can also use the curves palette to make primary color corrections. Simply click to create control points on the diagonal line inside the curve graph, and drag them up or down to adjust the master RGB contrast at different areas of image tonality. The optimum points to adjust are the bottom third, mid, and top third of the curve line.

There are many more ways of doing primary color correction in DaVinci Resolve. Check the DaVinci Resolve manual to learn how to use them all.

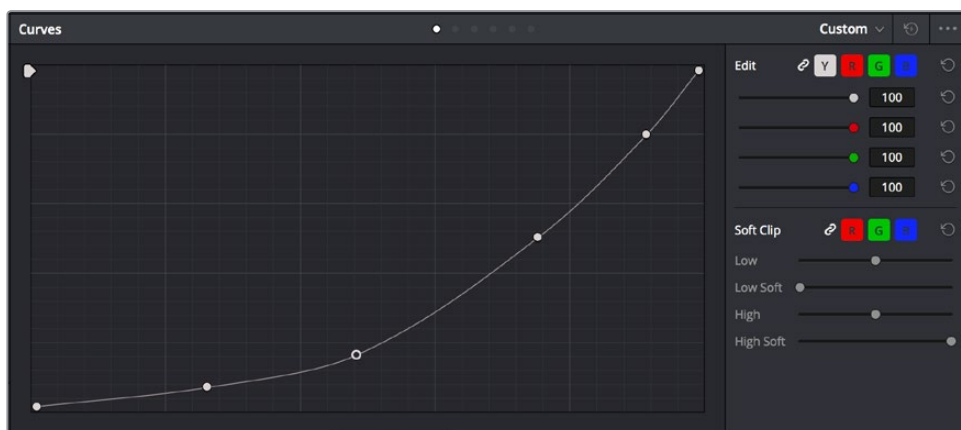

The curves palette is another tool you can use to make primary color corrections, or enhance specific areas of your clip when using a power window

Secondary Color Correction

If you want to adjust a specific part of your image then you need to use secondary corrections. The adjustments you have been doing up until now using the lift, gamma and gain adjustments affect the whole image at the same time and so they are called primary color corrections.

However, if you need to adjust specific parts of your image, say for example you wanted to improve the color in the grass in a scene, or you wanted to deepen the blue in a sky, then you can use secondary corrections. Secondary color corrections are where you select a part of the image and then adjust only that part. With nodes, you can stack multiple secondary corrections so you can keep working parts of your image until everything is just right! You can even use windows and tracking to allow the selections to follow movement in your images.

Qualifying a Color

Often you'll find a specific color in your clip can be enhanced, for example grass by the side of a road, or the blue in a sky, or you may need to adjust color on a specific object to focus the audience's attention on it. You can easily do this by using the HSL qualifier tool.



Using the HSL qualifier to select colors in your image is helpful when you want to make areas of your image 'pop', to add contrast, or to help draw the audience's attention to certain areas of your shot

To qualify a color:

- 1 Add a new serial node.
- 2 Open the 'qualifier' palette and make sure the 'selection range' picker tool is selected.
- 3 Click on the color in your clip you want to affect.
- 4 Usually you'll need to make some adjustments to soften the edges of your selection and limit the region to only the desired color. Click on the 'highlight' button above the viewer to see your selection.
- 5 Adjust the 'width' control in the 'hue' window to broaden or narrow your selection.

Experiment with the high, low and softness controls to see how to refine your selection. Now you can make corrections to your selected color using the color wheels or custom curves.

Sometimes your selection can spill into areas of the shot you don't want to affect. You can easily mask out the unwanted areas using a power window. Simply create a new window and shape it to select only the area of color you want. If your selected color moves in the shot, you can use the tracking feature to track your power window.

Adding a Power Window

Power windows are an extremely effective secondary color correction tool that can be used to isolate specific regions of your clips. These regions don't have to be static, but can be tracked to move with a camera pan, tilt or rotation, plus the movement of the region itself.



Use power windows to mask out areas you don't want to be affected by the HSL qualifier secondary adjustments

For example, you can track a window on a person in order to make color and contrast changes just to that person without affecting his or her surroundings. By making corrections like this you can influence the audience's attention on areas you want them to look at.

To add a power window to your clip:

- 1 Add a new serial node.
- 2 Open the 'window' palette and select a window shape by clicking on a shape icon. Your selected window shape will appear on the node.
- 3 Resize the shape by clicking and dragging the blue points around the shape. The red points adjust the edge softness. You can position the shape by clicking the center point and moving it to the area you want to isolate. Rotate the window using the point connected to the center.

Now you can make color corrections to your image in just the area you want.

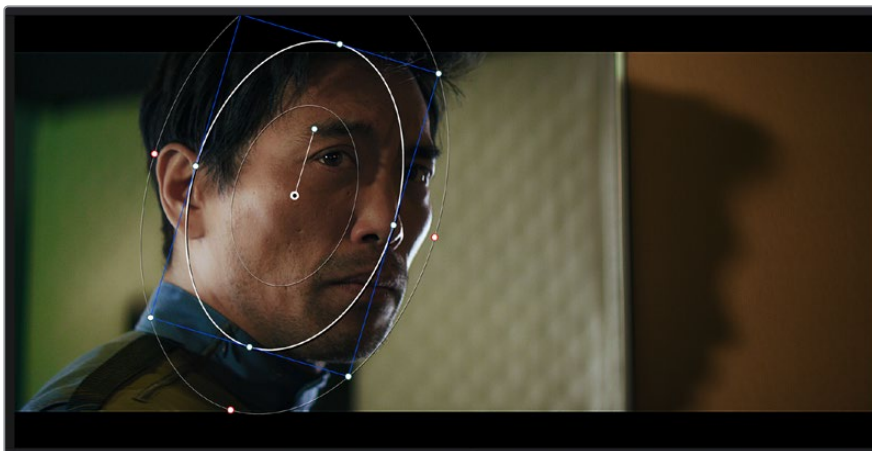

Power windows let you make secondary corrections to specific parts of your image

Tracking a Window

The camera, object or area in your shot may be moving, so to make sure your window stays on your selected object or area, you can use DaVinci Resolve's powerful tracking feature. The tracker analyzes the pan, tilt, zoom and rotation of the camera or object in your clip so you can match your windows to that movement. If this isn't done, your correction can move off the selected target and call attention to itself, which you probably don't want.

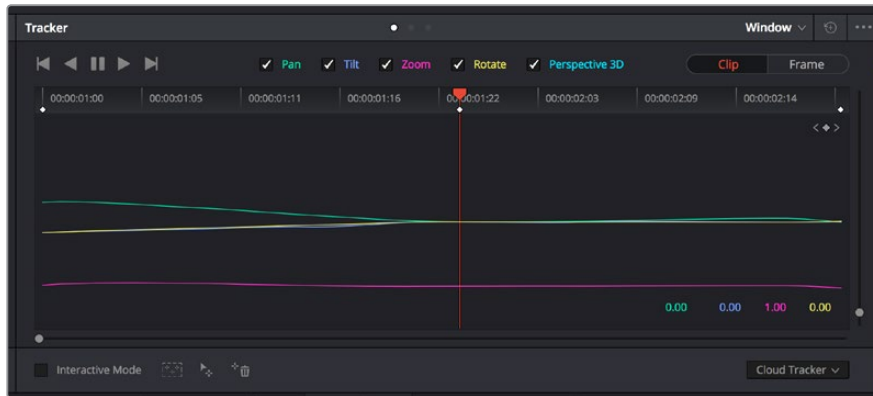

You can track objects or areas in your clip using the tracker feature so power windows can follow the action

To track a window to a moving object:

- 1 Create a new serial node and add a power window.
- 2 Go to the start of your clip and position and size the window to highlight just the object or area you want.
- 3 Open the 'tracker' palette. Select the pan, tilt, zoom, rotate, and perspective 3D settings appropriate for the movement in your clip by checking or unchecking the relevant 'analyze' checkboxes.
- 4 Click on the 'forward' arrow to the left of the checkboxes. DaVinci Resolve will now apply a cluster of tracking points on your clip and then step through the frames to analyze the movement. When the tracking is done, your power window will follow the path of the movement in your clip.

Most of the time automatic tracking is successful, but scenes can be complex and sometimes an object can pass in front of your selected area, interrupting or affecting your track. This can be solved manually using the keyframe editor. Refer to the DaVinci Resolve manual to find out more.

Using Plugins

While making secondary color corrections you can also add ResolveFX or OpenFX plugins to create fast, interesting looks and effects using the 'color' page, or imaginative transitions and effects on your clips on the 'edit' page. ResolveFX are installed with DaVinci Resolve, OFX plugins can be purchased and downloaded from third party suppliers.

After installing a set of OFX plugins, you can access them or ResolveFX plugins on the color page by opening the OpenFX inspector to the right of the 'node editor'. Once you create a new serial node, simply click the 'OpenFX' button to open the FX library and drag and drop a plugin onto the new node. If the plugin has editable settings, you can adjust these in the adjoining 'settings' panel.

In the 'edit' page you can add plugin filters, generators and transitions to clips by opening the 'OpenFX' panel in the 'effects library' and dragging your selected plugin onto the video clip or track above your clip on the timeline depending on the plugin requirements.

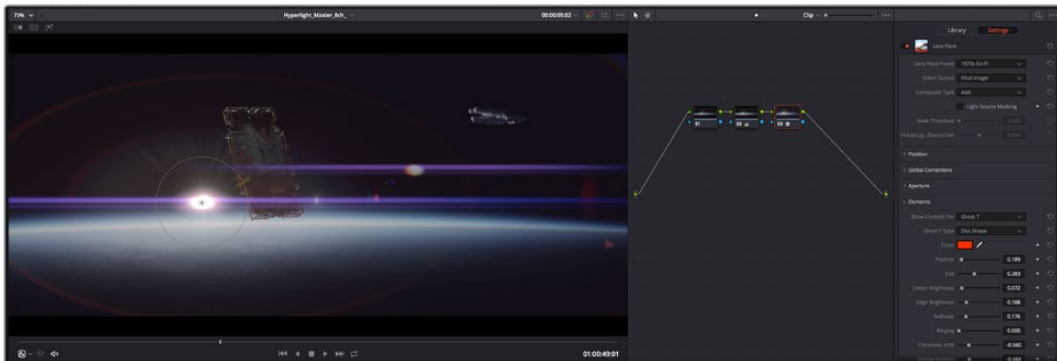

OpenFX plugins are a quick and easy way to create an imaginative and interesting look

Mixing Your Audio

Mixing Audio in the Edit Page

Once you have edited and color corrected your project, you can begin to mix your audio. DaVinci Resolve has a helpful set of features for editing, mixing and mastering audio for your project directly in the 'edit' page. For projects requiring more advanced audio tools, the Fairlight page provides you with a full audio post production environment. If you are already familiar with the edit page and want to move straight to Fairlight, skip this section and move onto the next.

Adding Audio Tracks

If you are working in the edit page and want to mix a basic sound edit with lots of sound effects and music, you can easily add more audio tracks when you need them. This can be helpful when building your sound, and separating your audio elements into individual tracks, for example, dialogue, sound effects and music.

To Add an Audio Track to the Edit Page

Right click next to the name of any audio track on your timeline and select 'add track' and choose from the options, including 'mono', 'stereo', and '5.1'. This will add the track to the bottom of the track list. Alternatively select 'add tracks' and select the position you would like the new track or multiple tracks placed.

Your new audio track will appear on the timeline.

TIP If you wish to change the type of track after creating it, right click next to the name of the track and select 'change track type to' and select the type of audio track you want, such as stereo, mono or 5.1.

Adjusting Audio Levels in the Timeline

Each clip of audio in the timeline has a volume overlay that lets you set that clip's level by simply dragging it up or down with the pointer. This overlay corresponds to the Volume parameter in the Inspector.

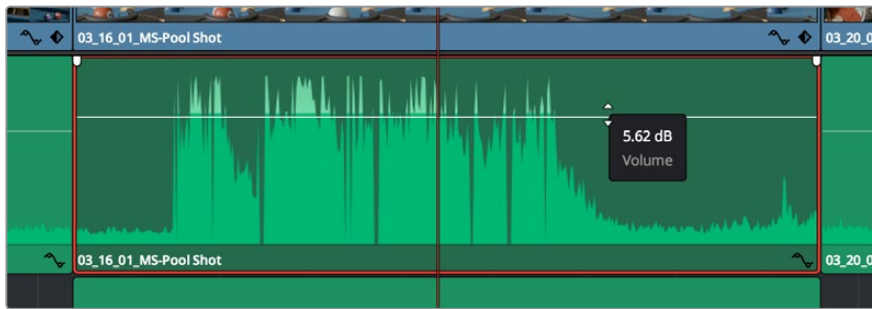

Dragging a volume overlay to adjust the clip level

For projects requiring more advanced audio tools, the Fairlight page provides you with a full audio post production environment.

The Fairlight Page

The 'Fairlight' page in DaVinci Resolve is where you adjust your project audio. In single monitor mode, this page gives you an optimized look at the audio tracks of your project, with an expanded mixer and custom monitoring controls that make it easy to evaluate and adjust levels in order to create a smooth and harmonious mix. Don't feel overwhelmed by the vast array of features in front of you, they are all there to help you deliver the best audio quality for your project.

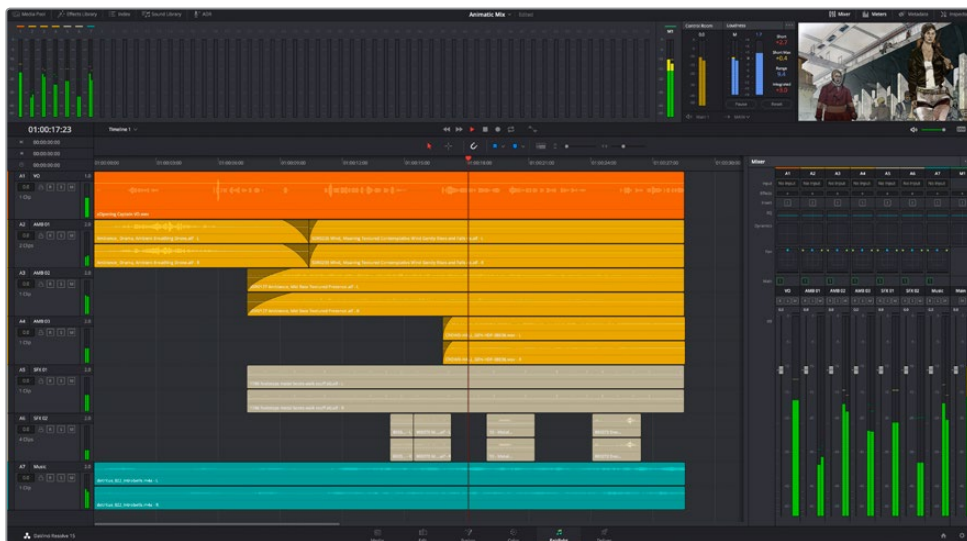

This guide provides a basic overview of the features on the Fairlight page, but to learn more about all the details for each feature, refer to the DaVinci Resolve manual. The DaVinci Resolve manual provides details on the purpose of each tool and describes how to use them in easy to follow steps.

The Audio Timeline

Track Header

At the left of each track is a header area that displays the track number, track name, track color, audio channels, fader value and audio meters. The track header also contains different controls for locking and unlocking tracks, plus solo and muting controls. These controls can help to keep your tracks organized, and let you preview individual tracks one at a time.

Tracks

Each track on the Fairlight page is divided into lanes, which show each individual channel of clip audio for editing and mixing. The edit page hides these individual audio channels, displaying only a single clip in the timeline to make it easier to edit multi channel sources without needing to manage a huge number of tracks.

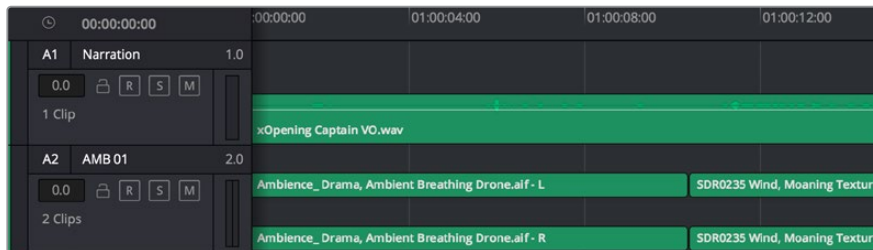

The track header on track A1 indicates a mono track with a single lane for mono audio, and the A2 track header indicates a stereo track with two lanes to accommodate stereo audio

What is a Bus?

A bus is essentially a destination channel to which you can route multiple audio tracks from the timeline, so that they are mixed together into a single signal that can be controlled via a single channel strip.

Main Bus

'Main busses' are typically the primary output of a program and each new project you create starts out with a single 'main bus', to which all tracks are routed by default. The 'main bus' combines all of the tracks in the timeline into one signal so that you can adjust the overall level of the audio mix once you have adjusted the level of each individual track.

Sub Bus

'Sub busses' allow you to combine multiple tracks of audio that belong to the same category such as dialogue, music or effects so that everything in that category can be mixed as a single audio signal. For example, if you have five dialogue tracks, you can route the output of all five dialogue tracks to a 'submix bus', and the level of all dialogue can then be mixed with a single set of controls. This submix can be rendered separately or sent to the main bus for render.

The Mixer

Each audio track in your timeline corresponds to an individual channel strip in the Mixer, and by default there's a single strip on the right for the 'main bus' labeled 'M1'. Additional channel strips will appear on the right hand side with a set of controls for each additional 'main' and 'submix bus' you create. A set of graphical controls allows you to assign track channels to output channels, adjust EQ and dynamics, set levels and record automation, pan stereo and surround audio, and mute and solo tracks.

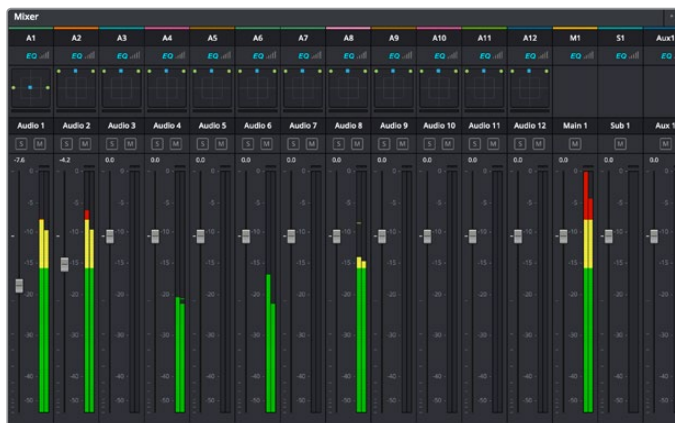

The audio mixer, with channel strips corresponding to the tracks in the timeline

Using the Equalizer to Enhance your Audio

After adjusting the audio levels of your audio clips in your project, you may find that the audio needs further finessing. In some cases you may find that the dialogue, music and sound effects are competing for the same frequency on the audio spectrum, making your audio too busy and unclear. This is where using EQ can help, as it allows you to specify the parts of the audio spectrum that each track occupies. You can also use an equalizer to help remove unwanted elements from your audio by isolating and reducing the level on particular frequencies that contain low rumbles, hums, wind noise and hiss, or simply to improve the overall quality of your sound so it is more pleasing to listen to.

DaVinci Resolve provides EQ filters that can be applied at a clip level to each individual clip or at the track level to affect entire tracks. Each audio clip in the timeline has a four band equalizer in the inspector panel, and each track has a 6 band parametric equalizer in the mixer panel. The graphical and numeric controls for boosting or attenuating different ranges of frequencies, and different filter types allow you to define the shape of the EQ curve.



The four band equalizer can be applied to every clip in the timeline

Outer bands let you make band filter adjustments using hi-shelf, lo-shelf, hi-pass and lo-pass filters. A pass filter affects all the frequencies above or below a particular frequency, by removing those frequencies completely from the signal. For example, a high pass filter will allow the high frequencies to pass through the filter while cutting the low frequencies. Any frequencies outside the cutoff frequency are cut gradually in a downward sloping curve.

A shelf filter is less aggressive, and is useful when you want to shape the overall top end or low end of the signal without completely removing those frequencies. The shelf filter boosts or cuts the target frequency and every frequency either above or below it evenly, depending on whether you use a high shelf or low shelf.

The middle sets of band controls let you make a wide variety of equalization adjustments, and can be switched between lo-shelf, bell, notch, and hi-shelf filtering options.

Bell

Bell filters boost or cut frequencies around a given center point of the bell curve, and as the name suggests the shape of the curve is like a bell.

Notch

Notch filters allow you to specifically target a very narrow range of frequencies. For example, removing a mains hum at 50 or 60Hz.

Lo-Shelf

Low shelf filters boost or cut the target frequency at the low end, and every frequency below it

Hi-Shelf

High shelf filters boost or cut the target frequency at the high end, and every frequency above it

To add EQ to an individual clip:

- 1 Select the clip in the timeline that you want to add the EQ filter to.
- 2 Click on the inspector and then click the 'clip equalizer' enable button.

To add EQ to a track:

- 1 Double click in the EQ section for one of your tracks in the mixer to open the equalizer for that track.
- 2 Select the band filter type from the dropdown menu for the band you want to adjust.



The EQ section in the mixer panel indicating an EQ curve has been applied to track one



The 6 Band parametric equalizer that can be applied to every track

Once you have added EQ to your clip or track, you can adjust the EQ for each band. Note that controls may vary depending on which band filter type is selected.

To adjust the EQ for a band filter:

- 1 Select the band filter type from the dropdown menu for the band you want to adjust.
- 2 Adjust the 'frequency' value to select the center frequency of the EQ adjustment.
- 3 Adjust the 'gain' value to boost or attenuate the frequencies governed by that band.
- 4 Use the 'Q factor' value to adjust the width of affected frequencies.

Use the reset button to reset all controls in the EQ window to their defaults.

Fairlight has many controls you can use to improve the quality of each audio track. You can add more tracks and arrange buses to organize them, plus add effects like delay or reverb, and generally perfect your audio mix.

Adding VFX and Compositing

Now that you have completed your edit, you can open the Fusion page to add 2D or 3D visual effects and motion graphics right within DaVinci Resolve. Unlike layer based compositing software, Fusion uses nodes, giving you the freedom to build complex effects while routing image data in any direction. The nodes window clearly shows every tool used along the way. If you have experienced the node workflow in the color page, this will feel familiar to you.

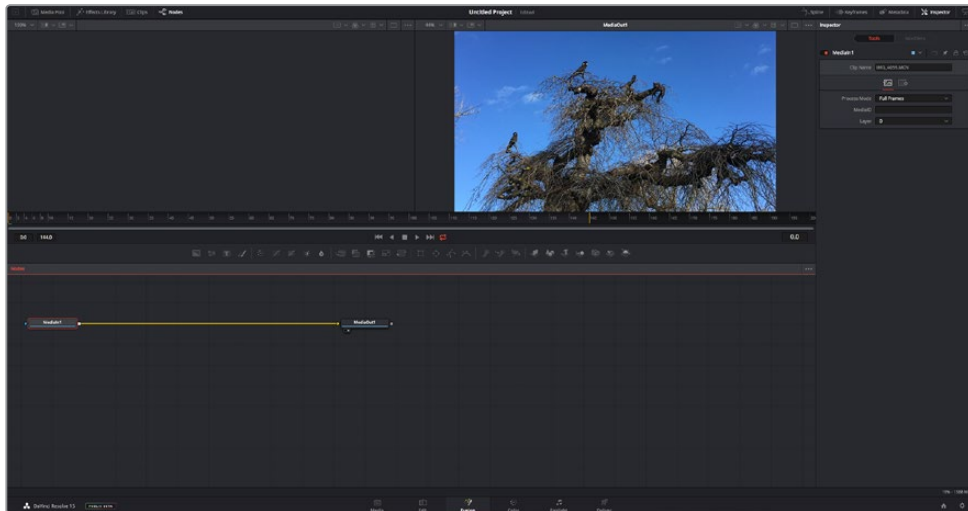

The Fusion Page

The Fusion page features 2 viewer windows across the top with transport controls to view your media, an inspector window to the right to access tool settings, and a nodes window at the bottom where you build your composition. While the viewers and transport controls are always visible, clicking on the icons on the interface toolbar at the very top of the display will let you show or hide the nodes and inspector windows, or reveal or hide additional windows including the effects library and editors for spline and keyframes.

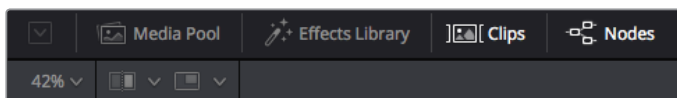

Media Pool

The media pool functions the same way as it appears in the edit page. Simply drag additional media from your bins directly to your composition.

Effects Library

The effects library is where you will find your Fusion tools and templates sorted into categories including particle, tracking, filters and generators. You can either click on the tool or drag it to the nodes area to add it to your composition. The media pool and effects library take up the same screen area, so you can swap between the two to keep your viewers as large as possible.

Clips

Clicking the clips tab will reveal or hide thumbnails representing clips on your timeline. The thumbnails are located underneath the nodes editor, letting you instantly navigate to other clips.

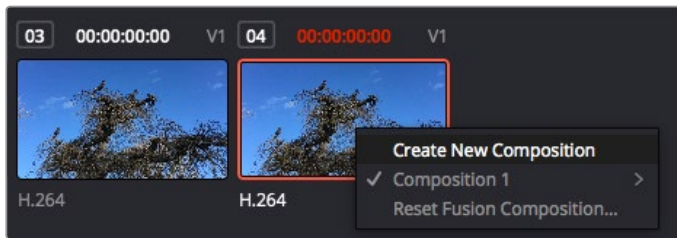

Create a new version of your composition by right clicking on a thumbnail and selecting 'create new composition'.

Viewers

The viewers are always visible and let you see the different views of your composition, for example an overall 3D perspective via the merge 3D node, a camera output, or your final render output. These viewers also let you see how your changes are affecting a specific element.

You can choose which nodes to view by clicking on a node and typing '1' for the left viewer or '2' for the right viewer. White button icons appear beneath the node to let you know which viewer it is assigned to. If you're using external video monitoring, there will be a third button available to route your media to your external video monitor.

TIP You can also assign a node to a viewer by dragging the node into the viewer itself.

The transport controls underneath the viewers let you skip to the start or end of the clip, play forward or reverse, or stop playback. The time ruler displays the entire range of a clip, with yellow marks indicating the in and out points.

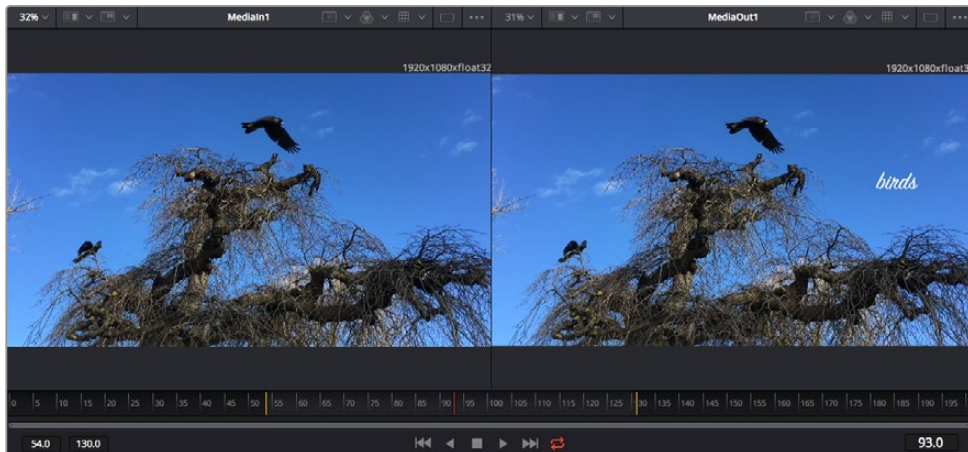

The yellow marks on the time ruler indicate your clip's in and out points on your timeline. If you are using a Fusion clip or compound clip, the time ruler will only show you the duration of the clip as it appears on the timeline, without handles.

Nodes

The nodes window is the heart of the Fusion page where you build your node tree by connecting tools together from one node's output to another node's input. This area will change size depending on which editors are open, for example the spline or keyframes editor. A toolbar at the top of the nodes area features the most commonly used tools for fast access.

Spline

When the spline editor is open, it will appear to the right of the nodes window. This editor lets you make precise adjustments to each node, such as smoothing the animation between two keyframes using bezier curves.

Keyframes

Keyframes for each tool can be added, removed or modified using the keyframes editor. This also appears to the right of the nodes viewer.

Metadata

The metadata window will show you metadata available for the active clip, including the codec, frame rate and timecode.

Inspector

The inspector in the top right corner displays all settings and modifiers available for one or more selected nodes. Additional tab options will appear to provide quick access to other settings for nodes sorted by category.

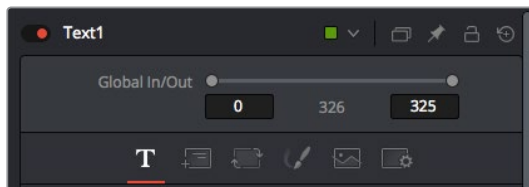

The text inspector contains additional tabs for text, layout, transform, shading, image and settings.

Getting Started with Fusion

To get started with Fusion, simply position your playhead over any clip on your timeline and click on the 'Fusion' tab to open the Fusion page.

On the Fusion page, your clip is immediately available in a media input node labelled 'MediaIn'. Every composition will begin with a 'mediain' and a 'mediaout' node. This mediain node represents the top most clip of your timeline at the playhead, and ignores any clips underneath. Any adjustments you've applied to the clip on the edit page, such as transform tools and cropping changes, are also included.

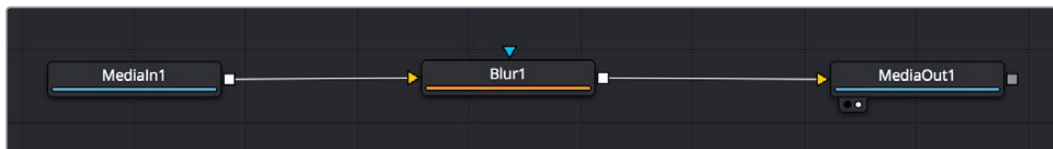

The media output node, named 'MediaOut', is the node that sends the output back to your timeline on DaVinci Resolve's edit page.

TIP ResolveFX or OFX plug-ins applied to clips in the edit page are not applied in the Fusion page. This is because Fusion effects occur prior to color correction and OFX/ResolveFX processing. If you want OFX applied before Fusion effects, right click the clip in the edit page and select 'new fusion clip' before clicking on the Fusion page.

Understanding Nodes

It can be helpful to think of each node as a visual icon representing a single tool or effect. Nodes are connected to other nodes to build the overall composition, much like ingredients in a cake. It's important to understand the inputs and outputs of each node as this will help you navigate the flow of your composition while building detailed visual effects.

Some tools have multiple inputs and outputs you can connect to other nodes. The merge node, for example, lets you attach a foreground input, background input, and a mask input for mattes or keys.

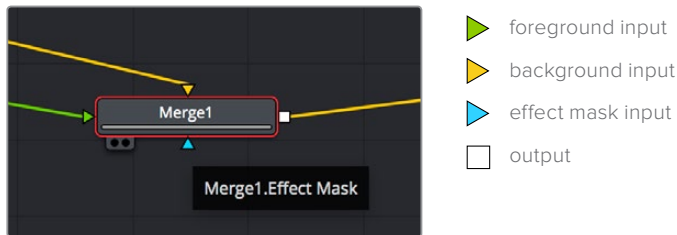

Multiple outputs on nodes means a single node can connect to many different nodes in your composition, so you don't have to duplicate clips as you would in layer based software. Arrows on the line between connected nodes are a great visual indicator to show you which direction the image data is flowing.

Adding Nodes to the Node Editor

Adding effects is as simple as placing nodes on the line between the 'mediain' and 'mediaout' nodes.

There are a few ways you can do this. You can hold down the shift button and drop a node between two nodes, or click on the node you want to attach an effect to and select the tool you want to add. The new node will automatically connect to the tool selected. You can also add a node anywhere on the node window and manually connect nodes by dragging the output of one to the input on another.

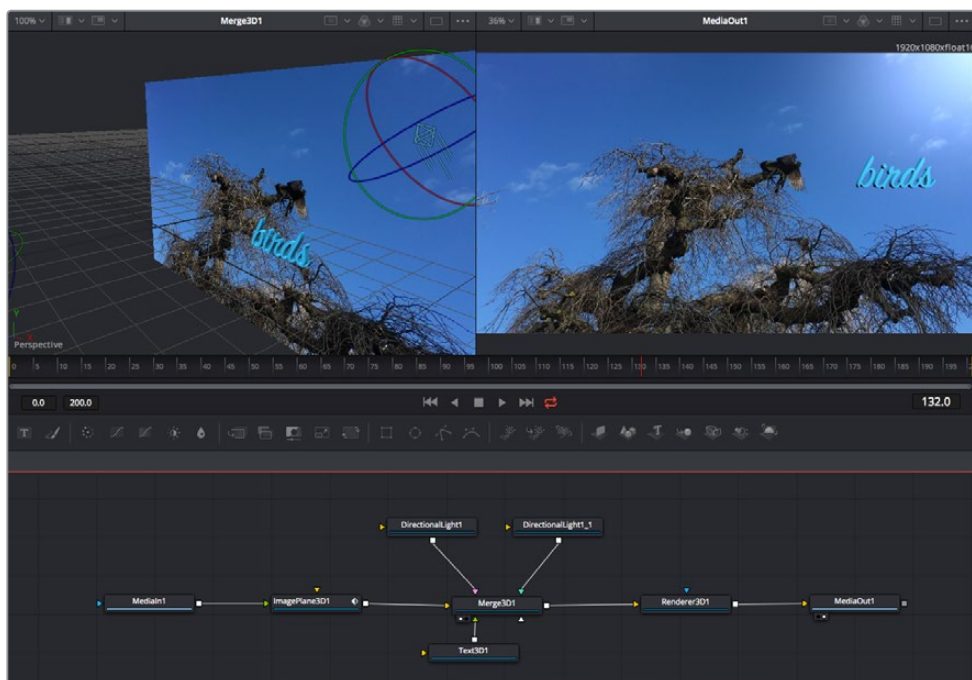

The most commonly used tool is the 2D or 3D merge node. This node is like a central hub that combines tools on the node editor into a single output.

The merge node has controls for how the inputs are managed, including settings for size, position, and blend. These settings are all accessible in the inspector panel when the merge node is selected.

The toolbar above the node panel contains the most commonly used tools as icons that you can either click on to add the node, or drag the tool to the node panel. If you want to see all the complete tools available, click on the 'effects library' in the top left corner and expand the 'tools' option. Here you'll find all the tools sorted by category, as well as a set of pre-built 'templates' you can use, for example lens flares, shaders and backgrounds.

TIP Once you're familiar with the tool names, you can hold down 'shift' and press 'spacebar' on your keyboard and a 'select tools' menu will appear. As you type the tool name, the menu will suggest the relevant tool. This is a very fast way to select the tool you want.

Adjusting Nodes Using the Inspector Panel

Adjust your node settings using the inspector panel. Simply click on the node you want to modify and the panel will update to display its settings and controls.

With Fusion, you don't have to be viewing the node you're editing, as you can modify one node while viewing another in your composition. For example, you can modify the size and center position of a 'text+' node while the merge node is in the viewer, letting you view the text relative to the background.



Selected nodes appear with a red border. Here the inspector panel is displaying the layout tab controls for the text node.

There are different parameters and settings you can adjust for every node depending on its task, from sizing and center positions to changing the number of particles in an emitter node. Setting keyframes and changing the settings over time will animate the effect.

Working with Keyframes

In the inspector window, set a keyframe by right clicking on a setting and choosing 'animate' from the contextual menu. The keyframe icon to the right of the setting will turn red. This means keyframes are now active and any changes you make will be applied to the current frame only. When two or more keyframes are created by changing the setting parameters on a different frame, a transition is interpolated between them. Arrows on each side of the keyframe icon let you move the playhead to those exact positions on the timeline.

The splines panel gives you further control over keyframe animation. You can select keyframes, such as the first and last, and smooth the animation between them into a bezier curve by typing 'shift' + 's', or right clicking on a keyframe and selecting 'smooth'.

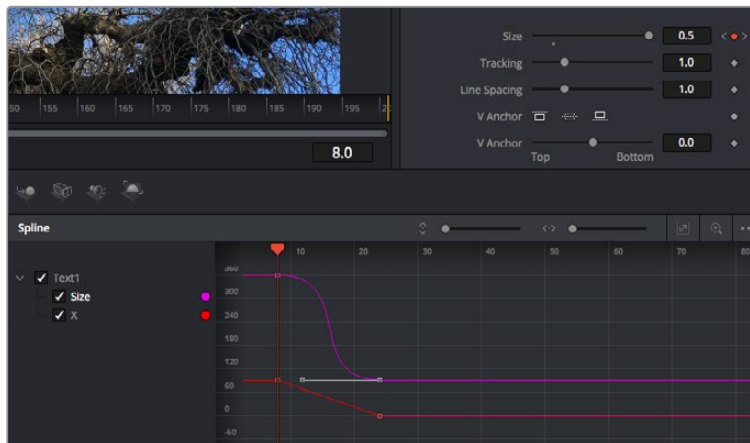

Here, the 'size' keyframe animation has been smoothed into a bezier curve. You can click the bezier handles to shorten or lengthen the curve, or the keyframe square icons to move the keyframe location.

Using the Motion Tracker and Adding Text

To get a better idea of how to use Fusion, we have included the following examples to show how to use the tracker tool to track an element in a clip, plus add text and attach it to the element using the tracking data.

The 'tracker' tool tracks pixels over time on the x & y axis, and generates data you can use to attach other elements. This is great for when you want to match the position of text to a moving object, such as a car driving along the road, or a bird as it flies across frame.

- 1 In the 'effects library', select the 'tracking' tool and drag it to the line between the 'mediain' and the 'mediaout' nodes. Now click the tracker node to reveal its properties in the inspector.
- 2 Type '1' on your keyboard to see the 'tracker' node on the left viewer. The clip will appear in the viewer together with the tracker at its default position. Hover your mouse pointer over the tracker to reveal the tracker handle. Click on the tracker handle at the top left corner and drag the tracker to an area of interest on your clip. High contrast areas work well, for example the badge on the hood of a car. The tracker will magnify the image area for extra precision.
- 3 In the inspector window, click on the 'track forward' button to start tracking. A notification window will appear when the tracking is done. Click OK.

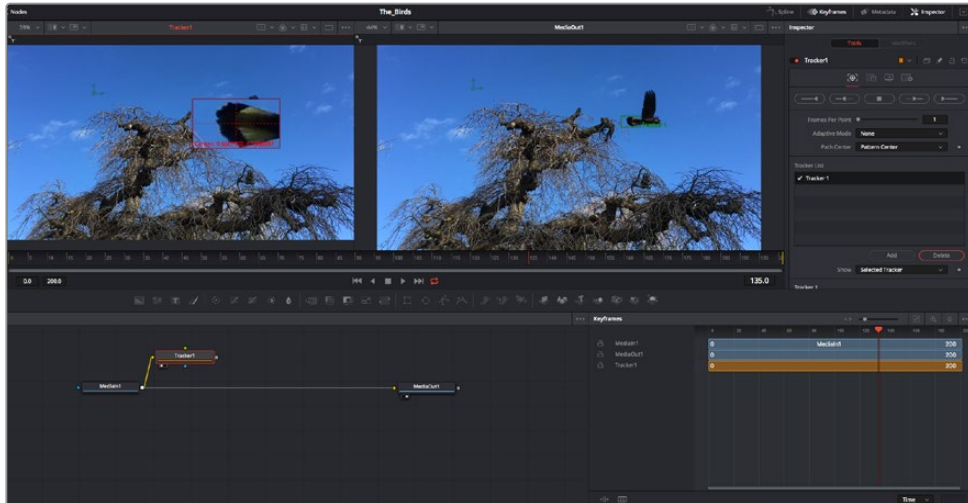

Tracking options in the inspector panel include track reverse from last frame or current frame, stop track or track forward from current frame or first frame.

TIP Track reverse or forward from current frame is great for situations where your area of interest disappears during the render range, such as a car or bird moving out of frame. This lets you track only the relevant footage.

Now you can take that tracking data and apply the motion path to a text tool.

- 1 Click on the 'text+' node icon from the toolbar of commonly used nodes and drag it to the node panel near the 'tracker' node. Connect the 'text' output square to the green foreground input on the 'tracker'.



- 2 Click on the 'tracker' node and type '1' so you can see the merged results on your left hand viewer. In the 'tracker' inspector panel, click on the 'operations' tab. You can see the tab's name by hovering the mouse pointer over it. Click the dropdown menu next to operation and select 'match move'.
- 3 Click the 'text' node to reveal the properties in the inspector. Type your text into the text box and change the font, color and size to suit your composition.

This will apply the tracking position data from your tracker to your text. If you want to change the text offset, click on the 'trackers' tab back in the inspector panel and use the x and y offset scroll wheels to modify the position.



Scroll wheels at the bottom of the tracker inspector panel let you adjust the offset position for the text.

Now you can play back your composition and see your text attached to the object you have tracked!

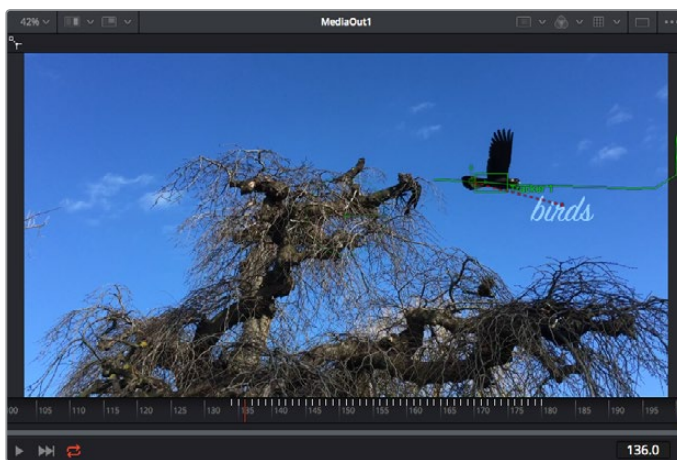

The green square is the tracker's current position along the green path, and the red dashed line is the offset position used to animate the text.

For some shots you might want to remove track points after tracking, such as when the object you are tracking disappears off the screen. The keyframe editor makes this a very simple process.

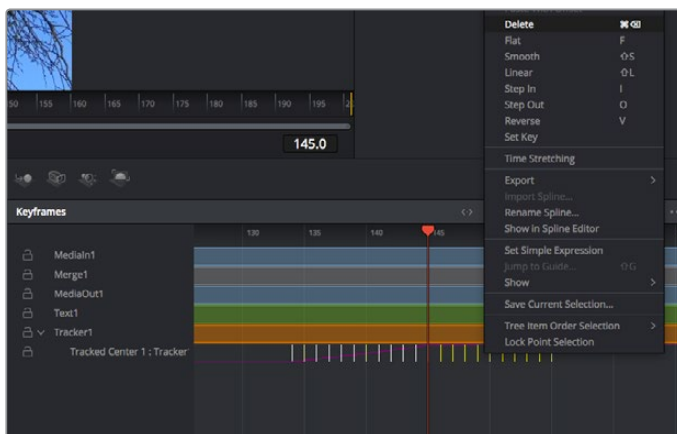

- 1 Click on the keyframes tab above the inspector to open the keyframes editor. Any nodes with keyframes applied will have a small arrow next to the node label, and only the parameter with keyframes added will appear in the list below. Click on the magnify icon and drag a box around the area you want to edit. This will zoom into that area so you can see the keyframes easier.
- 2 Move the playhead to the location of the last keyframe you want. Now select the keyframes you wish to remove by drawing a box around them with your mouse. The keyframes will highlight yellow. Right click and choose delete from the menu.

TIP If your effects are particularly system intensive, right clicking on the transport controls area will give you viewer options, including proxy playback, helping you get the most out of your system while you build your composition. Refer to the DaVinci Resolve manual for further detail on all the playback options.

You have now completed your first composition animating text to match a movement in your footage!

If you want to track an area of the image that contains a flat surface you want to enhance or replace, you can use the planar tracker. Tracking 2D planes can be helpful for changing labels and signs in a moving image, or even adding an image to a monitor or TV in your shot.

For more information about the planar tracker and the many powerful tools in the DaVinci Resolve Fusion page, refer to the DaVinci Resolve manual.

TIP As you build visual effects in the Fusion page, it's worth noting if the effect you are building is a 2D effect, or a 3D effect, as this will determine which merge tool is used. You may discover yourself frequently combining 2D and 3D effects in the one composite. In this scenario, it's helpful to remember that any visual effect using the 3D space needs to be rendered as a 2D image before it can be merged into a 2D composite.

We believe you will have lots of fun with Fusion and exploring Fusion's visual effects with the power of DaVinci Resolve's edit, color, and Fairlight pages. With all these tools at your finger tips, DaVinci Resolve is incredibly powerful and there is really no limit to what you can create!

Mastering your Edit

So now you've edited, graded, added vfx and mixed your audio, you'll want to export a render of your edit in the 'deliver' page. This page lets you select the range of clips you want to export, plus the format, codec and resolution you want. You can export in many types of formats such as QuickTime, AVI, MXF and DPX using codecs such as 8-bit or 10-bit uncompressed RGB/YUV, ProRes, DNxHD, H.264 and more.



The 'deliver' page is where you export your edit. You can select from many different video formats and codecs

To export a single clip of your edit:

- 1 Click on the 'deliver' tab to open the deliver page.
- 2 Go to the 'render settings' window on the top left of the page. Choose from a number of export presets, for example YouTube, Vimeo and audio presets, or you can set your own export settings manually by leaving it set to the default 'custom' preset and entering your own parameters. For this example, select YouTube, then click on the arrow next to the preset and select the 1080p video format.
- 3 Underneath the presets you will see the timeline filename and the target location for your exported video. Click the 'browse' button and choose the location where you want to save your exported file and then select 'single clip' from the render option.
- 4 Immediately above the timeline, you'll see an options box with 'entire timeline' selected. This will export the entire timeline, however you can select a range of the timeline if you want to. Simply choose 'in/out range' and then use the 'i' and 'o' hot key shortcuts to choose the in and out points in your timeline.
- 5 Go to the bottom of the 'render settings' and click on the 'add to render queue' button.

Your render settings will be added to the render queue on the right side of the page. Now all you have to do is click 'start render' and monitor the progress of your render in the render queue.

When your render is complete you can open the folder location, double click on your new rendered clip and watch your finished edit.

Working with Third Party Software

To edit your clips using your favorite editing software such as DaVinci Resolve, you can copy your clips from your camera to an external drive or RAID and then import your clips into the software. You can also import your clips directly from your storage media using a dock or adapter for your CFast or SD card, or via the USB-C port for a USB-C flash disk.

Working with Files from CFast 2.0 and SD cards

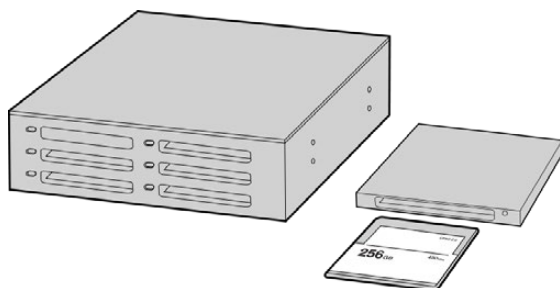

Edit directly from your CFast or SD card by removing it from your camera and mounting it on your computer using a CFast 2.0 reader/writer or CFast drive

To import your clips from a CFast 2.0 or SD card:

- 1 Remove the CFast or SD card from your Blackmagic Pocket Cinema Camera.
Mount the CFast or SD card to your Mac or Windows computer using a CFast 2.0 card reader SD card reader or CFast drive.
- 2 Double click on the CFast or SD card to open it and you should see folders that contain your Blackmagic RAW files or a list of QuickTime movie files. Depending on the format you chose to record in, you might have a mixture of files, but they should all use the same naming convention.
- 3 Drag the files you want from the CFast or SD card onto your desktop or another drive, or you can access the files straight from the CFast or SD card using your editing software.
- 4 Before you unplug the CFast or SD card from your computer, it is important to always eject your CFast or SD card from macOS or Windows. Removing your card without ejecting can corrupt footage.

Working with Files from USB-C flash disks

To import your clips from a USB-C flash disk:

- 1 Unplug the USB-C flash disk from your camera.
- 2 Mount the USB-C flash disk to your Mac OS X or Windows computer via a USB-C port on your computer. USB 3.0 is preferable as USB 2.0 is not fast enough to edit video in real time.
- 3 Double click on the USB-C flash disk to open it and you should see a list of QuickTime movie files or Blackmagic RAW files. Depending on the format you chose to record in, you might have a mixture of files, but they should all use the same naming convention.
- 4 Drag the files you want from the USB-C flash disk onto your desktop or another hard drive, or you can access the files straight from the USB-C flash disk using your NLE software.
- 5 Before you unplug the USB-C flash disk from your computer, it is important to eject the USB-C flash disk using Mac OS X or Windows first.

Using Final Cut Pro X

To edit your clips using Final Cut Pro X, you need to create a new project and set a suitable video format and frame rate. This example uses ProRes 422 HQ 1080p24.

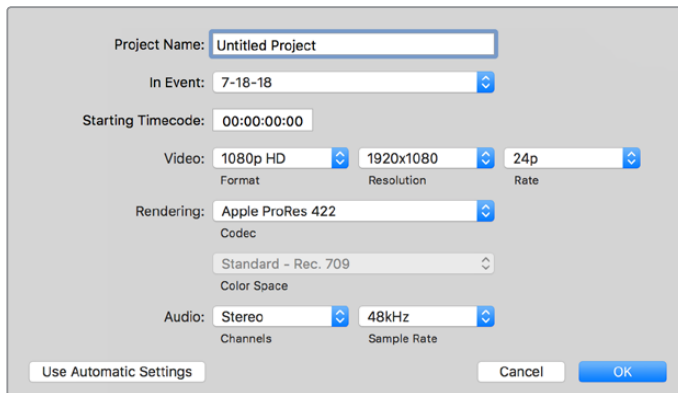

Final Cut Pro X project settings

- 1 Launch Final Cut Pro X, go to the 'menu' bar and select 'file/new project'. A window will open containing project settings.
- 2 Name your project and select the 'custom' checkbox.
- 3 Set the 'video properties' settings to 1080p HD, 1920x1080 and 24p.
- 4 Set your 'audio' and 'render properties' settings to 'stereo, 48kHz, and Apple ProRes 422 HQ'
- 5 Click OK.

To import your clips into your project, go to the 'menu' bar and select 'file/import/media'. Choose your clips from your CFast card.

You can now drag your clips onto the timeline for editing.

Using Avid Media Composer 2018

To edit your clips using Avid Media Composer 2018, create a new project and set a suitable video format and frame rate. For this example, clips are set using 1080p24.

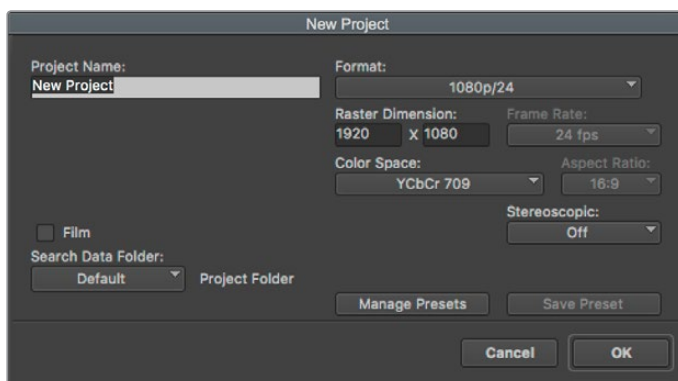

Setting the project name and project options in Avid Media Composer 2018

- 1 Launch Avid Media Composer 2018 and the 'select project' window will appear.
- 2 Click the 'new project' button and name your project in the 'new project' window.

- 3 In the 'format' drop down menu select HD 1080 > 1080p/24 and click 'ok' to create the project.
- 4 Double click the project in the 'select project' window to open it.
- 5 Select file > input > source browser and navigate to the files you wish to import.
- 6 Select your 'target bin' from the drop down menu and click 'import'.

When the clips appear in the media bin you can drag your clips onto the timeline and begin editing.

Using Adobe Premiere Pro CC

To edit your Apple ProRes 422 HQ clips using Adobe Premiere Pro CC, you need to create a new project and set a suitable video format and frame rate. For this example, clips are set using ProRes 422 HQ 1080p25.

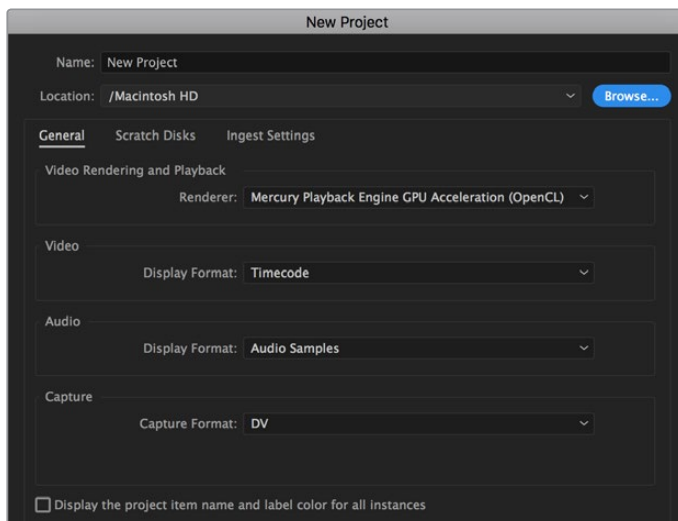

Setting the project name and project options in Adobe Premiere Pro CC

- 1 Launch Adobe Premiere Pro CC. In the 'welcome' window select 'new project'. A window will open containing project settings.
- 2 Name your project. Choose the location for your project by clicking 'browse' and selecting your desired folder. Once you've selected your location folder click OK in the 'new project' window.
- 3 Go to the Adobe Premiere Pro CC 'menu' bar, select 'file/import' and choose the clips you want to edit. Your clips will appear in the project window.
- 4 Drag the first clip you wish to edit onto the 'new item' icon at the bottom right of the project window. A new sequence will be created matching your clip settings.

You can now drag your clips onto the sequence timeline for editing.

Blackmagic Camera Setup Utility

Updating Camera Software – Mac

After downloading the Blackmagic Camera Setup utility software and unzipping the downloaded file, open the resulting disk image to reveal the Blackmagic Camera Setup Installer.

Launch the installer and follow the on screen instructions. After the installation has finished, go to your applications folder and open the Blackmagic Cameras folder, where you'll find this manual, the Blackmagic Camera setup utility, plus a documents folder containing readme files and information. You'll also find an uninstaller for when updating to later versions of Blackmagic Camera Setup.

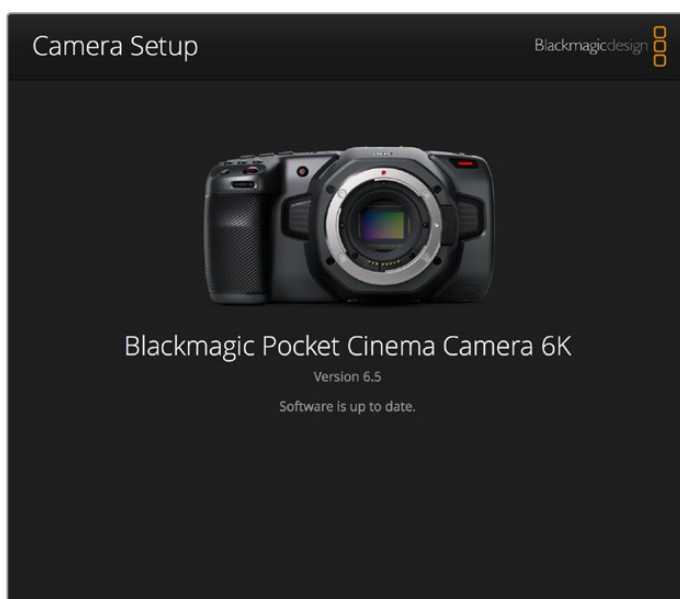

Updating Camera Software – Windows

After downloading the Blackmagic Camera Setup utility software and unzipping the downloaded file, you should see a Blackmagic Camera Setup folder containing this PDF manual and the Blackmagic Camera Setup Installer. Double-click the installer and follow the on screen prompts to complete the installation.

In Windows 10, click the start button and select 'all apps'. Scroll down to the Blackmagic design folder. From here you can launch Blackmagic Camera Setup.

In Windows 8.1, select the down arrow icon from the 'start' screen, and scroll down to the Blackmagic Design folder. From here you can launch Blackmagic Camera Setup.

Updating your Camera's Internal Software

After installing the latest Blackmagic Camera Setup utility on your computer, connect a USB-C cable between the computer and your camera.

The USB-C port is located on the left side panel. Simply open the rubber cap to access the port.

Launch the Blackmagic Camera Setup utility and follow the on screen prompts to update the camera software.

Developer Information

Blackmagic Bluetooth Camera Control

Blackmagic cameras with Bluetooth LE implement a variety of features and commands that allow users to control their cameras wirelessly. Developers have full access to these features for their custom applications.

The following services and characteristics describe the full range of communication options that are available to the developer.

Service: Device Information Service

UUID: 180A

Characteristics

Camera Manufacturer

UUID: 2A29

Read the name of the manufacturer (always “Blackmagic Design”).

Camera Model

UUID: 2A24

Read the name of the camera model (“Pocket Cinema Camera 6K” or “Pocket Cinema Camera 4K”).

Service: Blackmagic Camera Service

UUID: 291D567A-6D75-11E6-8B77-86F30CA893D3

Characteristics

Outgoing Camera Control (encrypted)

UUID: 5DD3465F-1AEE-4299-8493-D2ECA2F8E1BB

Send Camera Control messages

These messages are identical to those described in the Blackmagic SDI Camera Control Protocol section below. Please read that section for a list of supported messages and required formatting information.

For an example of how packets are structured, please see the ‘example protocol packets’ section in this document.

Incoming Camera Control (encrypted)

UUID: B864E140-76A0-416A-BF30-5876504537D9

Request notifications for this characteristic to receive Camera Control messages from the camera.

These messages are identical to those described in the Blackmagic SDI Camera Control Protocol section below. Please read that section for a list of supported messages and required formatting information.

Timecode (encrypted)

UUID: 6D8F2110-86F1-41BF-9AFB-451D87E976C8

Request notifications for this characteristic to receive timecode updates.

Timecode (HH:MM:SS:mm) is represented by a 32-bit BCD number:
(eg. 09:12:53:10 = 0x09125310)

Camera Status (encrypted)

UUID: 7FE8691D-95DC-4FC5-8ABD-CA74339B51B9

Request notifications for this characteristic to receive camera status updates.

The camera status is represented by flags contained in an 8-bit integer:

| | |
|---------------------------------|--------|
| None | = 0x00 |
| Camera Power On | = 0x01 |
| Connected | = 0x02 |
| Paired | = 0x04 |
| Versions Verified | = 0x08 |
| Initial Payload Received | = 0x10 |
| Camera Ready | = 0x20 |

Send a value of 0x00 to power a connected camera off.

Send a value of 0x01 to power a connected camera on.

Device Name

UUID: FFAC0C52-C9FB-41A0-B063-CC76282EB89C

Send a device name to the camera (max. 32 characters).

The camera will display this name in the Bluetooth Setup Menu.

Protocol Version

UUID: 8F1FD018-B508-456F-8F82-3D392BEE2706

Read this value to determine the camera's supported CCU protocol version.

NOTE Encrypted characteristics can only be used once a device has successfully bonded or paired with the Blackmagic Camera. Once a connection has been established, any attempt to write to an encrypted characteristic will initiate bonding. For example, writing a 'Camera Power On' (0x01) message to the Camera Status characteristic.

Once bonding is initiated, the camera will display a 6-digit pin in the Bluetooth Setup Menu. Enter this pin on your device to establish an encrypted connection. The device will now be able to read, write and receive notifications from encrypted characteristics.

Blackmagic SDI and Bluetooth Camera Control Protocol

Version 1.3

If you are a software developer you can use the SDI Camera Control Protocol to construct devices that integrate with our products. Here at Blackmagic Design our approach is to open up our protocols and we eagerly look forward to seeing what you come up with!

Overview

The Blackmagic SDI Camera Control Protocol is used by ATEM switchers, Blackmagic 3G-SDI Shield for Arduino and the Blackmagic Camera Control app to provide Camera Control functionality with supported Blackmagic Design cameras. Please refer to the 'Understanding Studio Camera Control' chapter section of this manual, or the ATEM Switchers Manual and SDK manual for more information. These can be downloaded at www.blackmagicdesign.com/support.

This document describes an extensible protocol for sending a uni directional stream of small control messages embedded in the non-active picture region of a digital video stream. The video stream containing the protocol stream may be broadcast to a number of devices. Device addressing is used to allow the sender to specify which device each message is directed to.

Assumptions

Alignment and padding constraints are explicitly described in the protocol document. Bit fields are packed from LSB first. Message groups, individual messages and command headers are defined as, and can be assumed to be, 32 bit aligned.

Blanking Encoding

A message group is encoded into a SMPTE 291M packet with DID/SDID x51/x53 in the active region of VANC line 16.

Message Grouping

Up to 32 messages may be concatenated and transmitted in one blanking packet up to a maximum of 255 bytes payload. Under most circumstances, this should allow all messages to be sent with a maximum of one frame latency.

If the transmitting device queues more bytes of message packets than can be sent in a single frame, it should use heuristics to determine which packets to prioritize and send immediately. Lower priority messages can be delayed to later frames, or dropped entirely as appropriate.

Abstract Message Packet Format

Every message packet consists of a three byte header followed by an optional variable length data block. The maximum packet size is 64 bytes.

| | |
|-----------------------------------|--|
| Destination device (uint8) | Device addresses are represented as an 8 bit unsigned integer. Individual devices are numbered 0 through 254 with the value 255 reserved to indicate a broadcast message to all devices. |
| Command length (uint8) | The command length is an 8 bit unsigned integer which specifies the length of the included command data. The length does NOT include the length of the header or any trailing padding bytes. |

| | |
|-------------------------------|--|
| Command id (uint8) | The command id is an 8 bit unsigned integer which indicates the message type being sent. Receiving devices should ignore any commands that they do not understand. Commands 0 through 127 are reserved for commands that apply to multiple types of devices. Commands 128 through 255 are device specific. |
| Reserved (uint8) | This byte is reserved for alignment and expansion purposes. It should be set to zero. |
| Command data (uint8[]) | The command data may contain between 0 and 60 bytes of data. The format of the data section is defined by the command itself. |
| Padding (uint8[]) | Messages must be padded up to a 32 bit boundary with 0x0 bytes. Any padding bytes are NOT included in the command length. |

Receiving devices should use the destination device address and or the command identifier to determine which messages to process. The receiver should use the command length to skip irrelevant or unknown commands and should be careful to skip the implicit padding as well.

Defined Commands

Command 0 : change configuration

| | |
|--------------------------|--|
| Category (uint8) | The category number specifies one of up to 256 configuration categories available on the device. |
| Parameter (uint8) | The parameter number specifies one of 256 potential configuration parameters available on the device. Parameters 0 through 127 are device specific parameters. Parameters 128 through 255 are reserved for parameters that apply to multiple types of devices. |
| Data type (uint8) | The data type specifies the type of the remaining data. The packet length is used to determine the number of elements in the message. Each message must contain an integral number of data elements. |

Currently defined values are:

| | |
|---------------------------------|---|
| 0: void / boolean | A void value is represented as a boolean array of length zero. The data field is a 8 bit value with 0 meaning false and all other values meaning true. |
| 1: signed byte | Data elements are signed bytes |
| 2: signed 16 bit integer | Data elements are signed 16 bit values |
| 3: signed 32 bit integer | Data elements are signed 32 bit values |
| 4: signed 64 bit integer | Data elements are signed 64 bit values |
| 5: UTF-8 string | Data elements represent a UTF-8 string with no terminating character. |

Data types 6 through 127 are reserved.

| | |
|-------------------------------------|--|
| 128: signed 5.11 fixed point | Data elements are signed 16 bit integers representing a real number with 5 bits for the integer component and 11 bits for the fractional component. The fixed point representation is equal to the real value multiplied by 2^{11} . The representable range is from -16.0 to 15.9995 ($15 + 2047/2048$). |
|-------------------------------------|--|

Data types 129 through 255 are available for device specific purposes.

| | |
|---------------------------------|---|
| Operation type (uint8) | The operation type specifies what action to perform on the specified parameter. Currently defined values are: |
| 0: assign value | The supplied values are assigned to the specified parameter. Each element will be clamped according to its valid range. A void parameter may only be 'assigned' an empty list of boolean type. This operation will trigger the action associated with that parameter. A boolean value may be assigned the value zero for false, and any other value for true. |
| 1: offset / toggle value | Each value specifies signed offsets of the same type to be added to the current parameter values. The resulting parameter value will be clamped according to their valid range. It is not valid to apply an offset to a void value. Applying any offset other than zero to a boolean value will invert that value. |

Operation types 2 through 127 are reserved.

Operation types 128 through 255 are available for device specific purposes.

| | |
|-------------|--|
| Data (void) | The data field is 0 or more bytes as determined by the data type and number of elements. |
|-------------|--|

The category, parameter, data type and operation type partition a 24 bit operation space.

| Group | ID | Parameter | Type | Index | Minimum | Maximum | Interpretation |
|-------|-----|--------------------------------|---------|-------|---------|---------|---|
| Lens | 0.0 | Focus | fixed16 | – | 0 | 1 | 0.0 = near, 1.0 = far |
| | 0.1 | Instantaneous autofocus | void | – | – | – | trigger instantaneous autofocus |
| | 0.2 | Aperture (f-stop) | fixed16 | – | -1 | 16 | Aperture Value (where fnumber = $\sqrt{2 \cdot AV}$) |
| | 0.3 | Aperture (normalised) | fixed16 | – | 0 | 1 | 0.0 = smallest, 1.0 = largest |
| | 0.4 | Aperture (ordinal) | int16 | – | 0 | n | Steps through available aperture values from minimum (0) to maximum (n) |
| | 0.5 | Instantaneous auto aperture | void | – | – | – | trigger instantaneous auto aperture |
| | 0.6 | Optical image stabilisation | boolean | – | – | – | true = enabled, false = disabled |
| | 0.7 | Set absolute zoom (mm) | int16 | – | 0 | max | Move to specified focal length in mm, from minimum (0) to maximum (max) |
| | 0.8 | Set absolute zoom (normalised) | fixed16 | – | 0 | 1 | Move to specified focal length: 0.0 = wide, 1.0 = tele |
| | 0.9 | Set continuous zoom (speed) | fixed16 | – | -1 | +1.0 | Start/stop zooming at specified rate: -1.0 = zoom wider fast, 0.0 = stop, +1 = zoom tele fast |

| Group | ID | Parameter | Type | Index | Minimum | Maximum | Interpretation | |
|-------|------------------------|-------------------------|------------------|-------------------------|------------|---|---|---|
| Video | 1.0 | Video mode | int8 | [0] = frame rate | – | – | 24, 25, 30, 50, 60 | |
| | | | | [1] = M-rate | – | – | 0 = regular, 1 = M-rate | |
| | | | | [2] = dimensions | – | – | 0 = NTSC, 1 = PAL, 2 = 720, 3 = 1080, 4 = 2k, 5 = 2k DCI, 6 = UHD | |
| | | | | [3] = interlaced | – | – | 0 = progressive, 1 = interlaced | |
| | | | | [4] = Color space | – | – | 0 = YUV | |
| | 1.1 | Gain (up to Camera 4.9) | int8 | | 1 | 16 | 1 = 100 ISO, 2 = 200 ISO, 4 = 400 ISO, 8 = 800 ISO, 16 = 1600 ISO | |
| | 1.2 | Manual White Balance | int16 | [0] = color temp | 2500 | 10000 | Color temperature in K | |
| | | | int16 | [1] = tint | -50 | 50 | tint | |
| | 1.3 | Set auto WB | void | – | – | – | Calculate and set auto white balance | |
| | 1.4 | Restore auto WB | void | – | – | – | Use latest auto white balance setting | |
| | 1.5 | Exposure (us) | int32 | | 1 | 42000 | time in us | |
| | 1.6 | Exposure (ordinal) | int16 | – | 0 | n | Steps through available exposure values from minimum (0) to maximum (n) | |
| | 1.7 | Dynamic Range Mode | int8 enum | – | 0 | 1 | 0 = film, 1 = video, | |
| | 1.8 | Video sharpening level | int8 enum | – | 0 | 3 | 0 = off, 1 = low, 2 = medium, 3 = high | |
| | 1.9 | Recording format | int16 | [0] = file frame rate | – | – | – | fps as integer (eg 24, 25, 30, 50, 60, 120) |
| | | | | [1] = sensor frame rate | – | – | – | fps as integer, valid when sensor-off-speed set (eg 24, 25, 30, 33, 48, 50, 60, 120), no change will be performed if this value is set to 0 |
| | | | | [2] = frame width | – | – | – | in pixels |
| | | | | [3] = frame height | – | – | – | in pixels |
| | | | | [4] = flags | – | – | – | [0] = file-M-rate |
| | | | | | – | – | – | [1] = sensor-M-rate, valid when sensor-off-speed-set |
| – | | | | | – | – | [2] = sensor-off-speed | |
| – | – | – | [3] = interlaced | | | | | |
| – | – | – | – | [4] = windowed mode | | | | |
| 1.10 | Set auto exposure mode | int8 | – | 0 | 4 | 0 = Manual Trigger, 1 = Iris, 2 = Shutter, 3 = Iris + Shutter, 4 = Shutter + Iris | | |
| 1.11 | Shutter angle | int32 | – | 100 | 36000 | Shutter angle in degrees, multiplied by 100 | | |
| 1.12 | Shutter speed | int32 | – | 24 | 2000 | Shutter speed value as a fraction of 1, so 50 for 1/50th of a second | | |
| 1.13 | Gain | int8 | – | -128 | 127 | Gain in decibel (dB) | | |
| 1.14 | ISO | int32 | – | 0 | 2147483647 | ISO value | | |

| Group | ID | Parameter | Type | Index | Minimum | Maximum | Interpretation |
|----------------------------|---------------|--|---------------------------|---------------------------|---------|--|---|
| Audio | 2.0 | Mic level | fixed16 | – | 0 | 1 | 0.0 = minimum, 1.0 = maximum |
| | 2.1 | Headphone level | fixed16 | – | 0 | 1 | 0.0 = minimum, 1.0 = maximum |
| | 2.2 | Headphone program mix | fixed16 | – | 0 | 1 | 0.0 = minimum, 1.0 = maximum |
| | 2.3 | Speaker level | fixed16 | – | 0 | 1 | 0.0 = minimum, 1.0 = maximum |
| | 2.4 | Input type | int8 | – | 0 | 2 | 0 = internal mic, 1 = line level input, 2 = low mic level input, 3 = high mic level input |
| | 2.5 | Input levels | fixed16 | [0] ch0 | 0 | 1 | 0.0 = minimum, 1.0 = maximum |
| | | | | [1] ch1 | 0 | 1 | 0.0 = minimum, 1.0 = maximum |
| 2.6 | Phantom power | boolean | – | – | – | true = powered, false = not powered | |
| Output | 3.0 | Overlay enables | uint16 bit field | – | – | – | bit flags: [0] = display status, [1] = display frame guides Some cameras don't allow separate control of frame guides and status overlays. |
| | 3.1 | Frame guides style (Camera 3.x) | int8 | [0] = frame guides style | 0 | 8 | 0 = HDTV, 1 = 4:3, 2 = 2.4:1, 3 = 2.39:1, 4 = 2.35:1, 5 = 1.85:1, 6 = thirds |
| | 3.2 | Frame guides opacity (Camera 3.x) | fixed16 | [1] = frame guide opacity | 0.1 | 1 | 0.0 = transparent, 1.0 = opaque |
| | 3.3 | Overlays (replaces .1 and .2 above from Cameras 4.0) | int8 | [0] = frame guides style | – | – | 0 = off, 1 = 2.4:1, 2 = 2.39:1, 3 = 2.35:1, 4 = 1.85:1, 5 = 16:9, 6 = 14:9, 7 = 4:3, 8 = 2:1 |
| | | | | [1] = frame guide opacity | 0 | 100 | 0 = transparent, 100 = opaque |
| [2] = safe area percentage | | | | 0 | 100 | percentage of full frame used by safe area guide (0 means off) | |
| [3] = grid style | | | | – | – | bit flags: [0] = display thirds, [1] = display cross hairs, [2] = display center dot | |
| Display | 4.0 | Brightness | fixed16 | – | 0 | 1 | 0.0 = minimum, 1.0 = maximum |
| | 4.1 | Overlay enables | int16 bit field | – | – | – | 0x4 = zebra |
| | | | | – | – | – | 0x8 = peaking |
| | | | | – | – | – | – |
| | 4.2 | Zebra level | fixed16 | – | 0 | 1 | 0.0 = minimum, 1.0 = maximum |
| | 4.3 | Peaking level | fixed16 | – | 0 | 1 | 0.0 = minimum, 1.0 = maximum |
| | 4.4 | Color bars display time (seconds) | int8 | – | 0 | 30 | 0 = disable bars, 1-30 = enable bars with timeout (s) |
| 4.5 | Focus Assist | int8 | [0] = focus assist method | – | – | 0 = Peak, 1 = Colored lines | |
| | | | [1] = focus line color | – | – | 0 = Red, 1 = Green, 2 = Blue, 3 = White, 4 = Black | |

| Group | ID | Parameter | Type | Index | Minimum | Maximum | Interpretation |
|---------------------|--------------------------|------------------------|-----------|--------------|---------|-------------|--|
| Tally | 5.0 | Tally brightness | fixed16 | – | 0 | 1 | Sets the tally front and tally rear brightness to the same level. 0.0 = minimum, 1.0 = maximum |
| | 5.1 | Front tally brightness | fixed16 | – | 0 | 1 | Sets the tally front brightness. 0.0 = minimum, 1.0 = maximum |
| | 5.2 | Rear tally brightness | fixed16 | – | 0 | 1 | Sets the tally rear brightness. 0.0 = minimum, 1.0 = maximum Tally rear brightness cannot be turned off |
| Reference | 6.0 | Source | int8 enum | – | 0 | 2 | 0 = internal, 1 = program, 2 = external |
| | 6.1 | Offset | int32 | – | – | – | +/- offset in pixels |
| Confi- guration | 7.0 | Real Time Clock | int32 | [0] time | – | – | BCD - HHMMSSFF (UCT) |
| | | | | [1] date | – | – | BCD - YYYYMMDD |
| | 7.1 | System language | string | – | – | – | ISO-639-1 two character language code |
| | 7.2 | Timezone | int32 | – | – | – | Minutes offset from UTC |
| | 7.3 | Location | int64 | [0] latitude | – | – | – |
| [1] longitude | | | | – | – | – | BCD - sDDDddddddddddd where s is the sign: 0 = west (-), 1 = east (+); DDD degrees, ddddddddddd decimal degrees |
| Color Correction | 8.0 | Lift Adjust | fixed16 | [0] red | -2 | 2 | default 0.0 |
| | | | | [1] green | -2 | 2 | default 0.0 |
| | | | | [2] blue | -2 | 2 | default 0.0 |
| | | | | [3] luma | -2 | 2 | default 0.0 |
| | 8.1 | Gamma Adjust | fixed16 | [0] red | -4 | 4 | default 0.0 |
| | | | | [1] green | -4 | 4 | default 0.0 |
| | | | | [2] blue | -4 | 4 | default 0.0 |
| | | | | [3] luma | -4 | 4 | default 0.0 |
| | 8.2 | Gain Adjust | fixed16 | [0] red | 0 | 16 | default 1.0 |
| | | | | [1] green | 0 | 16 | default 1.0 |
| | | | | [2] blue | 0 | 16 | default 1.0 |
| | | | | [3] luma | 0 | 16 | default 1.0 |
| | 8.3 | Offset Adjust | fixed16 | [0] red | -8 | 8 | default 0.0 |
| | | | | [1] green | -8 | 8 | default 0.0 |
| | | | | [2] blue | -8 | 8 | default 0.0 |
| [3] luma | | | | -8 | 8 | default 0.0 | |
| 8.4 | Contrast Adjust | fixed16 | [0] pivot | 0 | 1 | default 0.5 | |
| | | | [1] adj | 0 | 2 | default 1.0 | |
| 8.5 | Luma mix | fixed16 | – | 0 | 1 | default 1.0 | |
| 8.6 | Color Adjust | fixed16 | [0] hue | -1 | 1 | default 0.0 | |
| | | | [1] sat | 0 | 2 | default 1.0 | |
| 8.7 | Correction Reset Default | void | – | – | – | – | reset to defaults |

| Group | ID | Parameter | Type | Index | Minimum | Maximum | Interpretation | |
|-------|-------------|----------------|-------------------|-----------------------------|---------------------|---------|---|---|
| Media | 10.0 | Codec | int8 enum | [0] = basic codec | - | - | 1 = DNxHD, 2 = ProRes, 3 = Blackmagic RAW | |
| | | | | | - | - | ProRes: 0 = HQ, 1 = 422, 2 = LT, 3 = Proxy, 4 = 444, 5 = 444XQ | |
| | | | | [1] = codec variant | - | - | Blackmagic RAW: 0 = Q0, 1 = Q5, 2 = 3:1, 3 = 5:1, 4 = 8:1, 5 = 12:1 | |
| | 10.1 | Transport mode | int8 | [0] = mode | - | - | 0 = Preview, 1 = Play, 2 = Record | |
| | | | | [1] = speed | - | - | -ve = multiple speeds backwards, 0 = pause, +ve = multiple speeds forwards | |
| | | | | [2] = flags | - | - | 1<<0 = loop, 1<<1 = play all, 1<<5 = disk1 active, 1<<6 = disk2 active, 1<<7 = time-lapse recording | |
| | | | | [3] = slot 1 storage medium | - | - | 0 = CFast card, 1 = SD, 2 = SSD Recorder | |
| | | | | [4] = slot 2 storage medium | - | - | 0 = CFast card, 1 = SD, 2 = SSD Recorder | |
| | PTZ Control | 11.1 | Pan/Tilt Velocity | fixed 16 | [0] = pan velocity | -1.0 | 1.0 | -1.0 = full speed left, 1.0 = full speed right |
| | | | | | [1] = tilt velocity | -1.0 | 1.0 | -1.0 = full speed down, 1.0 = full speed up |
| 11.1 | | Memory Preset | int8 enum | [0] = preset command | - | - | 0 = reset, 1 = store location, 2 = recall location | |
| | | | int8 | [1] = preset slot | 0 | 5 | - | |

Example Protocol Packets

| Operation | Packet Length | Byte | | | | | | | | | | | | | | | |
|--|---------------|-------------|--------|---------|----------|----------|-----------|------|-----------|------|------|------|------|------|------|------|------|
| | | 0 | 1 | 2 | 3 | 4 | 5 | 6 | 7 | 8 | 9 | 10 | 11 | 12 | 13 | 14 | 15 |
| | | header | | command | | | | data | | | | | | | | | |
| | | destination | length | command | reserved | category | parameter | type | operation | | | | | | | | |
| trigger instantaneous auto focus on camera 4 | 8 | 4 | 4 | 0 | 0 | 0 | 1 | 0 | 0 | | | | | | | | |
| turn on OIS on all cameras | 12 | 255 | 5 | 0 | 0 | 0 | 6 | 0 | 0 | 1 | 0 | 0 | 0 | | | | |
| set exposure to 10 ms on camera 4 (10 ms = 10000 us = 0x00002710) | 12 | 4 | 8 | 0 | 0 | 1 | 5 | 3 | 0 | 0x10 | 0x27 | 0x00 | 0x00 | | | | |
| add 15% to zebra level (15 % = 0.15 f = 0x0133 fp) | 12 | 4 | 6 | 0 | 0 | 4 | 2 | 128 | 1 | 0x33 | 0x01 | 0 | 0 | | | | |
| select 1080p 23.98 mode on all cameras | 16 | 255 | 9 | 0 | 0 | 1 | 0 | 1 | 0 | 24 | 1 | 3 | 0 | 0 | 0 | 0 | 0 |
| subtract 0.3 from gamma adjust for green & blue (-0.3 ~ = 0xfd9a fp) | 16 | 4 | 12 | 0 | 0 | 8 | 1 | 128 | 1 | 0 | 0 | 0x9a | 0xfd | 0x9a | 0xfd | 0 | 0 |
| all operations combined | 76 | 4 | 4 | 0 | 0 | 0 | 1 | 0 | 0 | 255 | 5 | 0 | 0 | 0 | 6 | 0 | 0 |
| | | 1 | 0 | 0 | 0 | 4 | 8 | 0 | 0 | 1 | 5 | 3 | 0 | 0x10 | 0x27 | 0x00 | 0x00 |
| | | 4 | 6 | 0 | 0 | 4 | 2 | 128 | 1 | 0x33 | 0x01 | 0 | 0 | 255 | 9 | 0 | 0 |
| | | 1 | 0 | 1 | 0 | 24 | 1 | 3 | 0 | 0 | 0 | 0 | 0 | 4 | 12 | 0 | 0 |
| | | 8 | 1 | 128 | 1 | 0 | 0 | 0x9a | 0xfd | 0x9a | 0xfd | 0 | 0 | | | | |

Help

The fastest way to obtain help is to go to the Blackmagic Design online support pages and check the latest support material available for your camera.

Blackmagic Design Online Support Pages

The latest manual, software and support notes can be found at the Blackmagic Design support center at www.blackmagicdesign.com/support.

Contacting Blackmagic Design Support

If you can't find the help you need in our support material, please use the 'Send us an email' button on the support page to email a support request. Alternatively, click on the 'Find your local support team' button on the support page and call your nearest Blackmagic Design support office.

Checking the Software Version Currently Installed

To check which version of Blackmagic Camera Setup utility software is installed on your computer, open the About Blackmagic Camera Setup utility window.

- On macOS, open Blackmagic Camera Setup utility from the Applications folder. Select About Blackmagic Camera Setup utility from the application menu to reveal the version number.
- On Windows, open Blackmagic Camera Setup utility from your Start menu or Start Screen. Click on the Help menu and select About Blackmagic Camera Setup utility to reveal the version number.

How to Get the Latest Software Updates

After checking the version of Blackmagic Camera Utility software installed on your computer, please visit the Blackmagic Design support center at www.blackmagicdesign.com/support to check for the latest updates. While it is usually a good idea to run the latest updates, it is wise to avoid updating any software if you are in the middle of an important project.

Regulatory Notices

Disposal of Waste of Electrical and Electronic Equipment Within the European Union.



The symbol on the product indicates that this equipment must not be disposed of with other waste materials. In order to dispose of your waste equipment, it must be handed over to a designated collection point for recycling. The separate collection and recycling of your waste equipment at the time of disposal will help conserve natural resources and ensure that it is recycled in a manner that protects human health and the environment. For more information about where you can drop off your waste equipment for recycling, please contact your local city recycling office or the dealer from whom you purchased the product.



This equipment has been tested and found to comply with the limits for a Class A digital device, pursuant to Part 15 of the FCC rules. These limits are designed to provide reasonable protection against harmful interference when the equipment is operated in a commercial environment. This equipment generates, uses, and can radiate radio frequency energy and, if not installed and used in accordance with the instructions, may cause harmful interference to radio communications. Operation of this product in a residential area is likely to cause harmful interference, in which case the user will be required to correct the interference at personal expense.

Operation is subject to the following two conditions:

- 1 This device may not cause harmful interference.
- 2 This device must accept any interference received, including interference that may cause undesired operation.

ISED Canada Statement

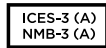

This device complies with Canadian standards for Class A digital apparatus.

Any modifications or use of this product outside its intended use could void compliance to these standards.

Connection to HDMI interfaces must be made with high quality shielded HDMI cables.

This equipment has been tested for compliance with the intended use in a commercial environment. If the equipment is used in a domestic environment, it may cause radio interference.

Bluetooth®

The product is a Bluetooth wireless technology enabled product.

Contains transmitter module FCC ID: QOQBGM113

This equipment complies with FCC radiation exposure limits set forth for an uncontrolled environment.

Contains transmitter module IC: 5123A-BGM113

This device complies with Industry Canada's license-exempt RSS standards and exception from routine SAR evaluation limits given in RSS-102 Issue 5.

Certified for Japan, certificate number: 209-J00204. This equipment contains specified radio equipment that has been certified to the technical regulation conformity certification under the radio law.

This module has certification in South Korea, KC certification number: MSIP-CRM-BGT-BGM113

Hereby, Blackmagic Design declares that the product is using wideband transmission systems in 2.4 GHz ISM band is in compliance with directive 2014/53/EU.

The full text of the EU declaration of conformity is available from compliance@blackmagicdesign.com.

Safety Information

Blackmagic Pocket Cinema Camera is suitable for use in tropical locations with an ambient temperature of up to 40°C.

No operator serviceable parts inside product. Refer servicing to your local Blackmagic Design service center.

During sunny conditions, consider shading of the camera to prevent exposure of the camera or lithium battery to extended periods of sunlight. Keep lithium batteries away from all sources of heat.



When using the supplied power adapter, use only at altitudes not more than 2000m above sea level.

State of California statement

This product can expose you to chemicals such as trace amounts of polybrominated biphenyls within plastic parts, which is known to the state of California to cause cancer and birth defects or other reproductive harm.

For more information go to www.P65Warnings.ca.gov.

Warranty

Limited Warranty

Blackmagic Design warrants that this product will be free from defects in materials and workmanship for a period of 12 months from the date of purchase. If a product proves to be defective during this warranty period, Blackmagic Design, at its option, either will repair the defective product without charge for parts and labor, or will provide a replacement in exchange for the defective product.

In order to obtain service under this warranty, you the Customer, must notify Blackmagic Design of the defect before the expiration of the warranty period and make suitable arrangements for the performance of service. The Customer shall be responsible for packaging and shipping the defective product to a designated service center nominated by Blackmagic Design, with shipping charges pre paid. Customer shall be responsible for paying all shipping charges, insurance, duties, taxes, and any other charges for products returned to us for any reason.

This warranty shall not apply to any defect, failure or damage caused by improper use or improper or inadequate maintenance and care. Blackmagic Design shall not be obliged under this warranty: a) to repair damage resulting from attempts by personnel other than Blackmagic Design representatives to install, repair or service the product, b) to repair damage resulting from improper use or connection to incompatible equipment, c) to repair any damage or malfunction caused by the use of non Blackmagic Design parts or supplies, or d) to service a product that has been modified or integrated with other products when the effect of such a modification or integration increases the time or difficulty of servicing the product.

THIS WARRANTY IS GIVEN BY BLACKMAGIC DESIGN IN LIEU OF ANY OTHER WARRANTIES, EXPRESS OR IMPLIED. BLACKMAGIC DESIGN AND ITS VENDORS DISCLAIM ANY IMPLIED WARRANTIES OF MERCHANTABILITY OR FITNESS FOR A PARTICULAR PURPOSE. BLACKMAGIC DESIGN'S RESPONSIBILITY TO REPAIR OR REPLACE DEFECTIVE PRODUCTS DURING THE WARRANTY PERIOD IS THE WHOLE AND EXCLUSIVE REMEDY PROVIDED TO THE CUSTOMER. BLACKMAGIC DESIGN WILL NOT BE LIABLE FOR ANY INDIRECT, SPECIAL, INCIDENTAL OR CONSEQUENTIAL DAMAGES IRRESPECTIVE OF WHETHER BLACKMAGIC DESIGN OR THE VENDOR HAS ADVANCE NOTICE OF THE POSSIBILITY OF SUCH DAMAGES. BLACKMAGIC DESIGN IS NOT LIABLE FOR ANY ILLEGAL USE OF EQUIPMENT BY CUSTOMER. BLACKMAGIC IS NOT LIABLE FOR ANY DAMAGES RESULTING FROM USE OF THIS PRODUCT. USER OPERATES THIS PRODUCT AT OWN RISK.

© Copyright 2019 Blackmagic Design. All rights reserved. 'Blackmagic Design', 'URSA', 'DeckLink', 'HDLink', 'Workgroup Videohub', 'Multibridge Pro', 'Multibridge Extreme', 'Intensity' and 'Leading the creative video revolution' are registered trademarks in the US and other countries. All other company and product names may be trademarks of the respective companies with which they are associated.

The Bluetooth word, mark and logos are registered trademarks owned by Bluetooth SIG, Inc. and any use of such marks by Blackmagic Design is under license. Other trademarks and trade names are those of the respective owners.