



Qumi Z1V

User Manual

説明書

사용 설명서

用戶手冊

คู่มือการใช้

Bedienungsanleitung

Manuel d'utilisation

Руководство пользователя

Manual de usuario

Manuale Utente

TABLE OF CONTENTS

- Important Safety Information 4**
 - Symbols Used 4
 - General Safety Information 5
 - Qumi Z1V Installation Notice 5
 - Power Supply Safety 6
 - Cleaning Qumi 6
 - Control Warning 6

- Regulatory Compliance 7**
 - FCC Warning 7
 - Canada 7
 - Safety Certifications 7
 - Disposal and Recycling 7

- Introduction 8**
 - About this Manual 8
 - Qumi Z1V Main Features 8

- Package Contents 9**

- Your Projector 10**
 - Front-Left View 10
 - Rear View 10
 - Top View 11
 - Bottom View 12

- Remote Control 13**
 - Remote Control Keypad 13
 - Activating the Remote Control Battery 14
 - Replacing the Remote Control Battery 14

- Powering/Charging the Projector 15**
 - Powering On/Off the Projector 16

Making Connections	18
Using the Projector	19
Adjusting the Focus	19
Playing Video from a Storage Device (USB Flash Drive, microSD Card)	20
Viewing Photos from a Storage Device (USB Flash Drive, microSD Card)	22
Playing Audio from a Storage Device (USB Flash Drive, microSD Card)	25
Playing from a Video Source (HDMI)	27
Using the Bluetooth® Speaker	29
Using the Settings Menu	31
The Settings Menu	33
Display Settings	33
Audio Settings.....	34
Image Settings.....	35
Timer.....	36
Other Settings.....	36
Troubleshooting/FAQ	37
Tips	37
System Reset Method (Reboot)	37
Image Problems	38
Remote Control Problems	38
Audio Problems	39
FAQs	39
Vivitek Support Site	40
Additional Information	41
Projection Distance vs Projection Size	41
Timing Mode Table.....	42
Specifications	43

IMPORTANT SAFETY INFORMATION



IMPORTANT:

It is strongly recommended that you read this section carefully before using Qumi Z1V. These safety and usage instructions will make sure you enjoy many years of safe use of Qumi Z1V. Keep this manual for future reference.

Symbols Used

Warning symbols are used on the unit and in this manual to alert you of hazardous situations. The following symbols are used to call attention to important information.



NOTE:

Provides additional information on the topic at hand.



IMPORTANT:

Provides additional information that should not be overlooked.



CAUTION:

Alerts you to situations that may damage the unit.



WARNING:

Alerts you to situations that may damage the unit, create a hazardous environment, or cause personal injury.

Throughout this manual, component parts and items in the OSD (On-Screen Display) menus are denoted in bold font as in this example:

“Press the **Menu** button on top of the projector or remote control to open the **Settings** menu”.

General Safety Information

- RG1 IEC 62471-5:2015
- Do not open the casing. There are no user-maintainable parts inside the machine. For any maintenance, please contact a qualified service technician.
- Follow all warnings and precautions on the machine or in this Manual.
- According to its design, the projection light source is extremely bright. To avoid harm to your eyes, do not look straight at the lens when the LED is ON.
- Do not place the machine on unstable surface or stand.
- Avoid using the system near water, in direct sunlight, or near a heating device.
- Do not place any heavy objects (e.g., books or bags) on the unit.

Qumi Z1V Installation Notice

- Allow at least a 500mm (20") clearance around the exhaust vent.

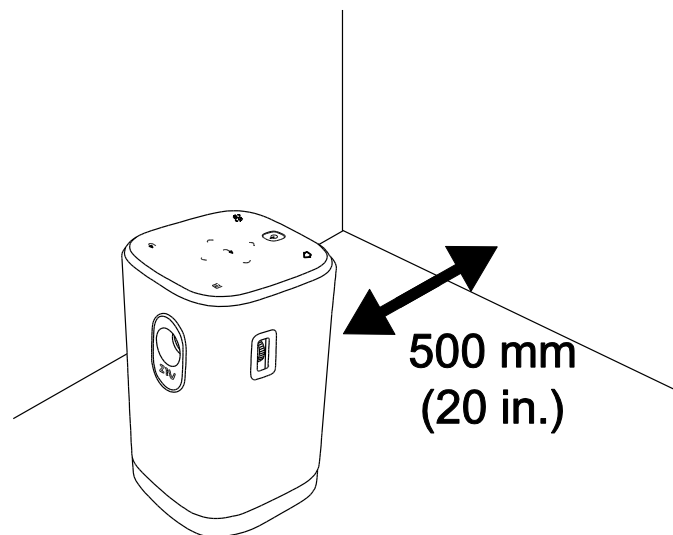

- Make sure that the intake vents do not recycle hot air from the exhaust vent.
- When operating Qumi Z1V in an enclosed space, make sure that the surrounding air temperature within the enclosure does not exceed the operating temperature while Qumi Z1V is running, and the air intake and exhaust vents are unobstructed.
- All enclosures should pass a certified thermal evaluation to make sure that Qumi Z1V does not recycle exhaust air, as this may cause the device to shut down even if the enclosure temperature is within the acceptable operating temperature range.



CAUTION:

Avoid usage of Qumi Z1V in dusty environments.

Power Supply Safety

- Only use the supplied adapter.
- Do not place anything on the cord. Place the cord where it will not be in the way of foot traffic.
- Remove the battery from the remote control when storing or not in use for a prolonged period.

Cleaning Qumi

- Before cleaning, disconnect the power supply cables. Refer to **Powering On/Off the Projector** on page **16**.



NOTE:

Qumi Z1V will be warm after usage. Allow Qumi Z1V to cool down before storing away.

Control Warning

Before installing and using Qumi Z1V, read the regulatory notices in the **Regulatory Compliance** on page **7**.

REGULATORY COMPLIANCE

FCC Warning

This equipment has been tested and found to comply with the limits for a Class B digital device pursuant to Part 15 of the FCC Rules. These limits are designed to provide reasonable protection against harmful interference when the equipment is operated in a commercial environment.

This equipment generates, uses, and can radiate radio frequency energy and, if not installed and used in accordance with the instruction manual, may cause harmful interference to radio communications. Operation of this equipment in a residential area is likely to cause harmful interference in which case the user will be required to correct the interference at his/her own expense.

Any Changes or modifications not expressly approved by the parties responsible for compliance could void the user's authority to operate the equipment.

Canada

This class B digital apparatus complies with Canadian ICES-003.

Safety Certifications

Projector: CENB, REACH, ROHS, WEEE, FCCID, TUV NORTH AMERICA, SRRC, CB, BQB

Power Adapter: DOE, WEEE, FCC, UL, EAC, TUV-GS, CB, PSB, TUV-S, EAC, KCC, CCC, CECP, BIS, BSMI, ISC

Disposal and Recycling

This product may contain other electronic waste that can be hazardous if not disposed of properly. Recycle or dispose in accordance with local, state, or federal Laws. For more information, contact the Electronic Industries Alliance at www.eiae.org.



DISPOSAL:

Do not use household or municipal waste collection services for disposal of electrical and electronic equipment. EU countries require the use of separate recycling collection services.

INTRODUCTION

About this Manual

This manual is intended for end users and describes how to install and operate Qumi Z1V. Wherever possible, relevant information—such as an illustration and its description—has been kept on one page. This printer-friendly format is both for your convenience and to help save paper, thereby protecting the environment. It is suggested that you only print sections that are relevant to your needs.

Qumi Z1V Main Features

- Native WVGA (854 x 480) resolution with a maximum resolution of 1080p (1920 x 1080)
- Texas Instruments DLP® chip technology for long-lasting precise color, image quality and low power consumptions
- Long lasting, energy efficient RGB LED light source for up to 30,000 hours of operation
- Dual 5watt speakers pump out crisp, clear and dynamic sound for an incredible theater-quality audio experience
- Standalone Bluetooth® speaker for convenient audio playback from a smartphone, tablet or other BT enabled audio device
- Assortment of connectivity options including HDMI, USB, microSD and earphone audio-out
- PC-free playback of photos, videos and audio files with the integrated multimedia player
- Up to 2 hours of continuous on-the-go entertainment with the built-in 4,000mAH battery
- Dual infrared sensors for handy remote control from either in front or behind
- Lightweight friendly profile for easy movement and transportation
- Tripod port for convenient projector setup and positioning

PACKAGE CONTENTS

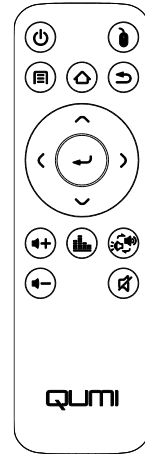
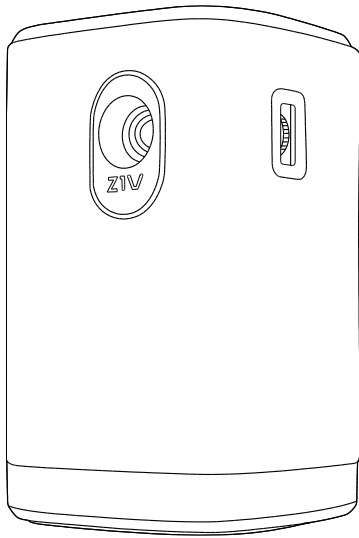

Qumi Z1V

Remote Control

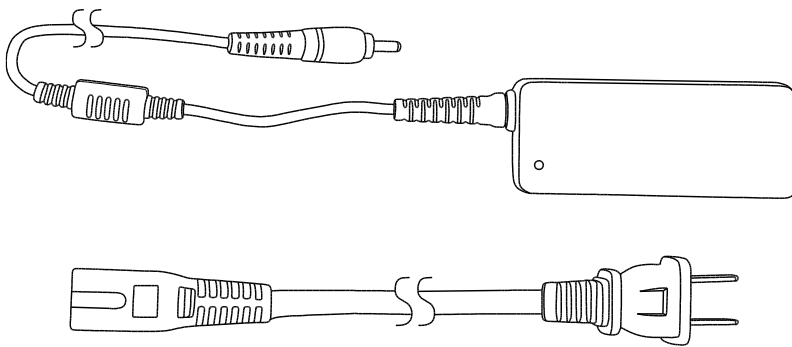

Adapter

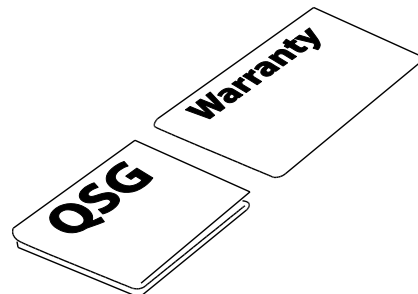
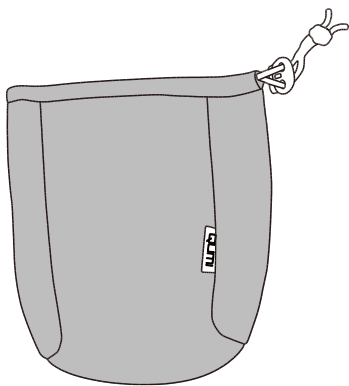

Carry Bag

Documentation

YOUR PROJECTOR

Front-Left View

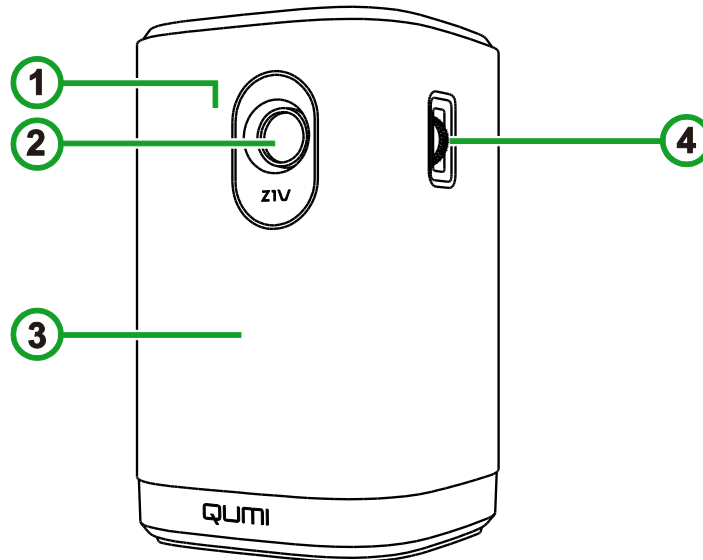

1 Front IR Sensor

2 Lens

3 Front Speaker

4 Focus Dial

Rear View

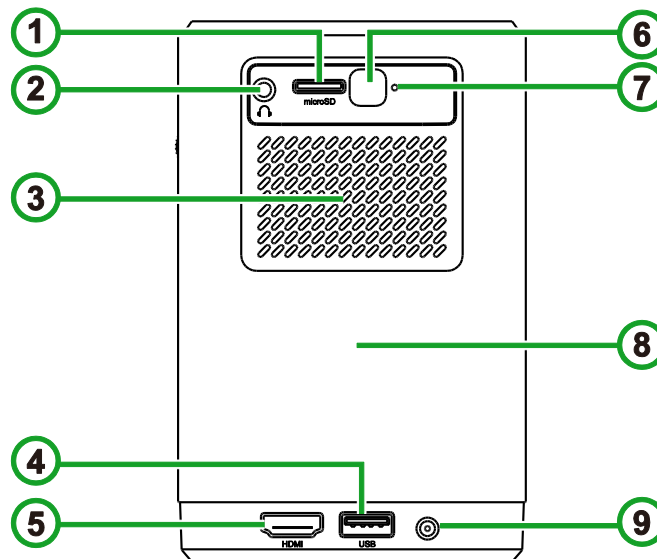

1 microSD slot

2 Audio Out (3.5mm)
Jack

3 Air Vent

4 Type-A USB Port

5 HDMI Port

6 Rear IR Sensor

7 Reset Button

8 Rear Speaker

9 DC In Port

Top View

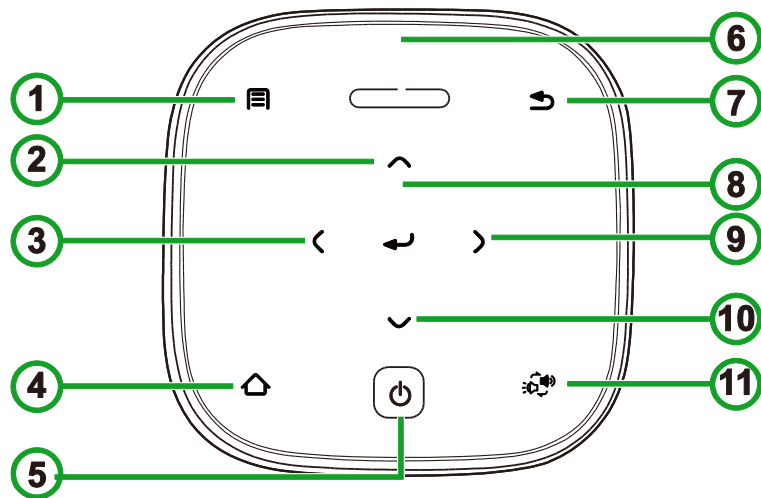

- | | | |
|----------------------|-------------------------------|--|
| 1 Menu Button | 5 Power Button | 9 Right Button |
| 2 Up Button | 6 LED Status Indicator | 10 Down Button |
| 3 Left Button | 7 Exit Button | 11 Bluetooth® Speaker Mode Button |
| 4 Home Button | 8 Enter Button | |

Projector Status	LED Behavior and Definition	
	Adapter Disconnected	Adapter Connected
Powered Off	Off	Red: Charging
		Green: Fully Charged
Projector Mode	Blinking Red: Low Battery	Red: Charging
	Green: Projecting	Green: Projecting With Battery Fully Charged
Bluetooth Speaker Mode	Solid Red: Low Battery	Blinking Blue: Waiting to Pair*
	Blinking Blue: Waiting to Pair*	Breathing Blue: Pairing Failed*
	Breathing Blue: Pairing Failed*	Solid Blue: Bluetooth Connected
	Solid Blue: Bluetooth Connected	

*If Bluetooth pairing has failed, exit Bluetooth speaker mode and then try again.

Bottom View

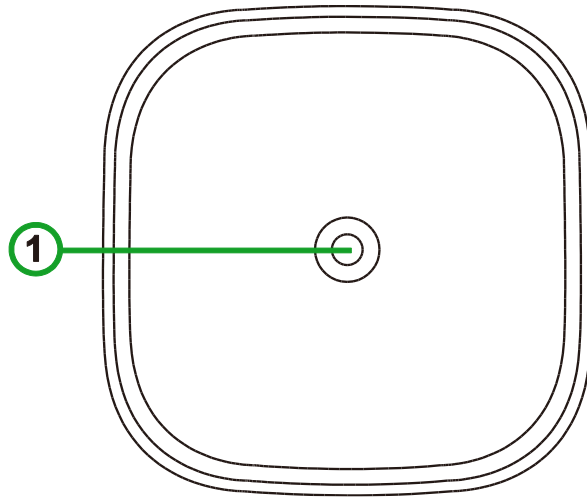

1 Tripod Connector

REMOTE CONTROL

Remote Control Keypad

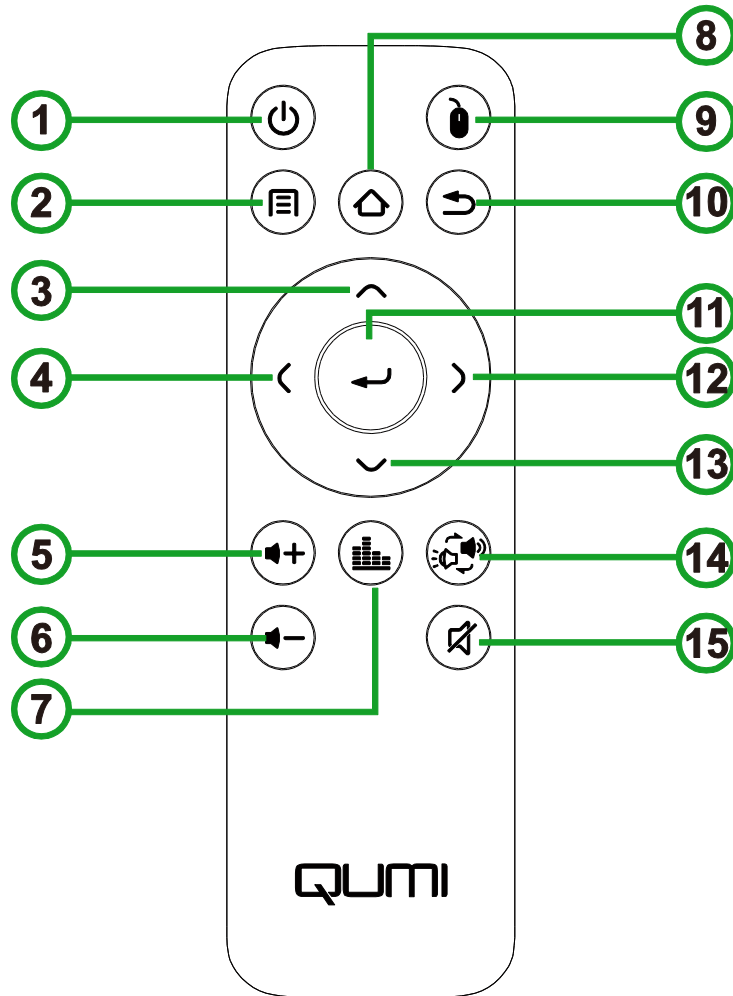

1	Power ON/OFF	6	Volume -	11	Enter
2	Menu	7	Audio Mode	12	Right
3	Up	8	Home	13	Down
4	Left	9	Mouse*	14	Bluetooth® Speaker Mode
5	Volume +	10	Exit	15	Mute



NOTE:

*This feature is not available for the current model of Qumi Z1V

Activating the Remote Control Battery

When using the remote control for the first time, the plastic sticker covering the battery must be removed. To remove the plastic sticker, pull the tab at the bottom side of the remote control to remove the plastic sticker from the battery compartment.

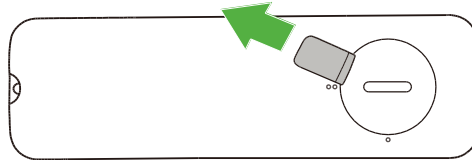

Replacing the Remote Control Battery

To replace the remote control battery:

1. Rotate the battery compartment cover counter-clockwise so the line on the cover points to the single dot on the remote control.
2. Remove the battery compartment cover.

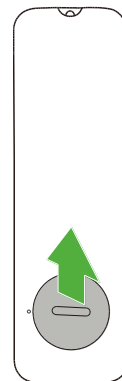

3. Remove the old battery and replace it with the new battery.
4. Place the battery compartment cover back on the battery compartment and rotate the cover clockwise so the line on the cover points to the double alignment dots.

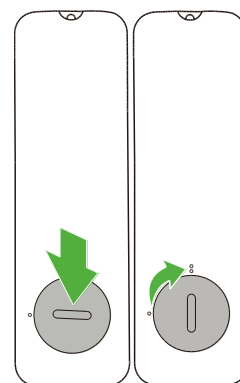
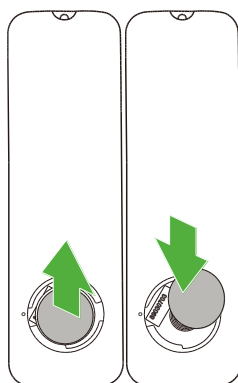

POWERING/CHARGING THE PROJECTOR

To supply power to the Qumi Z1V:

1. Connect the power cable to a power socket
2. Connect the power cable to the supplied adapter.
3. Connect the adapter cable to the DC In port on the projector.

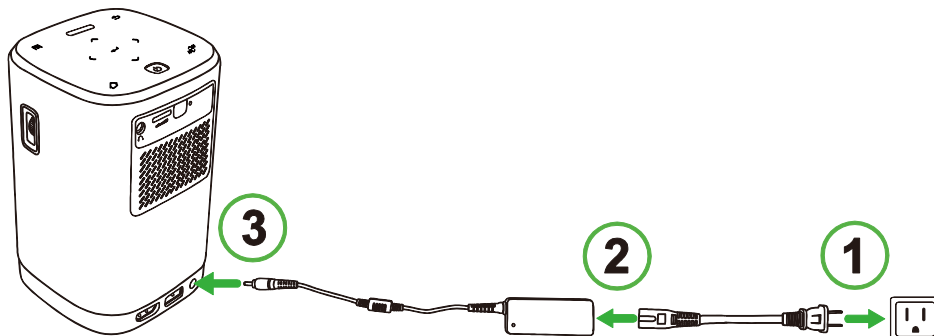

4. Once the adapter and power cable are connected to the projector, the LED status indicator on the top of the projector will illuminate indicating the charge status (refer to **Top View** on page 11 for more information on LED behavior).

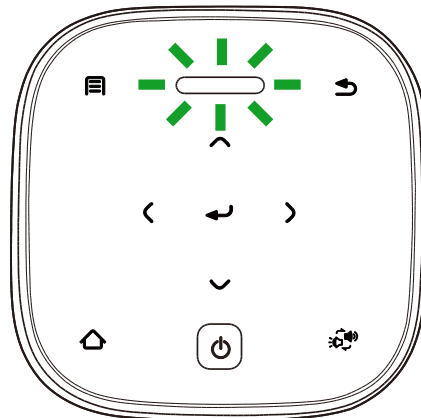

The charging status will also be indicated on the home screen.

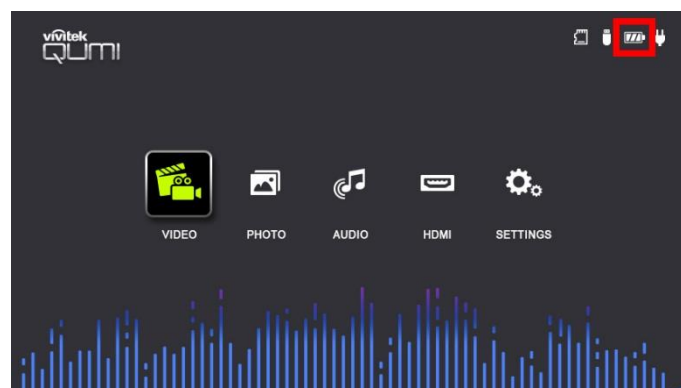

Powering On/Off the Projector

To power on the projector:

1. Press the power (⏻) button on the top of the projector or the power (⏻) button on the remote control.

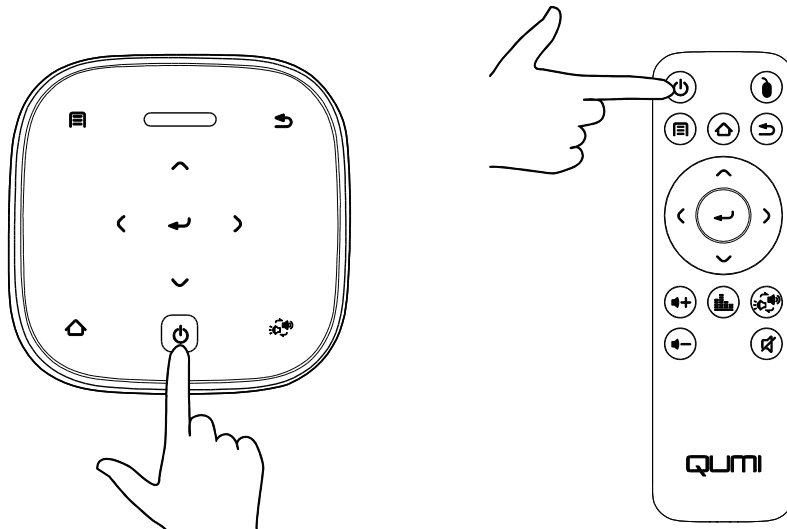

IMPORTANT:

The remote control can only power on the projector when the projector is connected to a power supply.

2. The fans will begin to operate and the Qumi logo will appear on the screen:

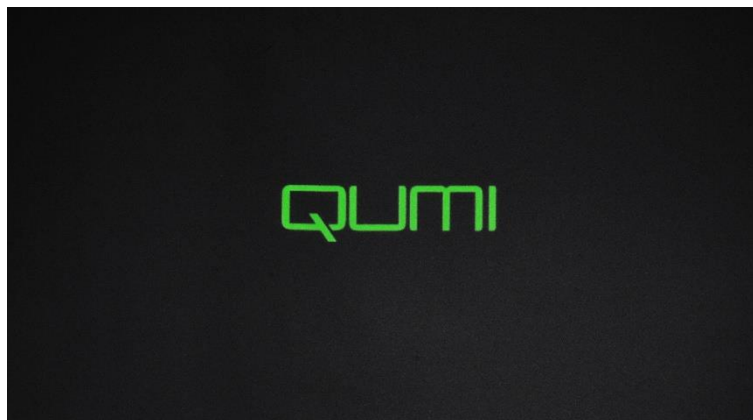

To power off the projector:

1. Press the power (⏻) button on the top of the projector or the power (⏻) button on the remote control.

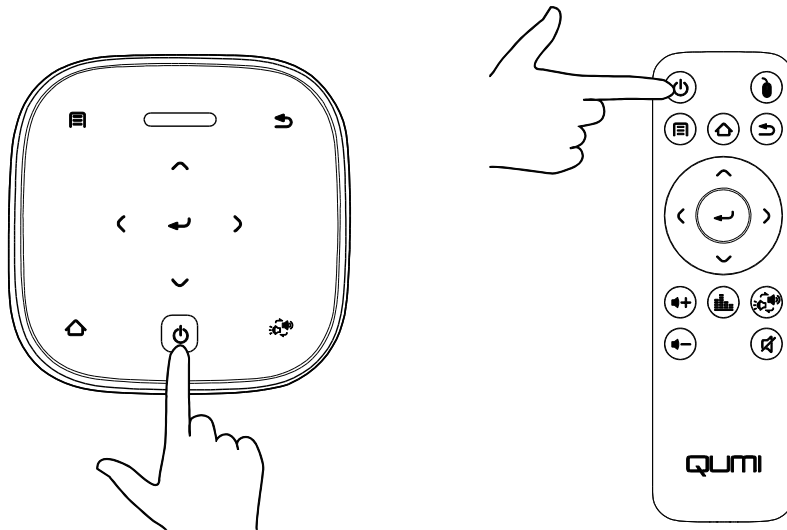

2. A message will appear on the projected screen to confirm power off. Press the power (⏻) button on the top of the projector or the power (⏻) button on the remote control again.



MAKING CONNECTIONS

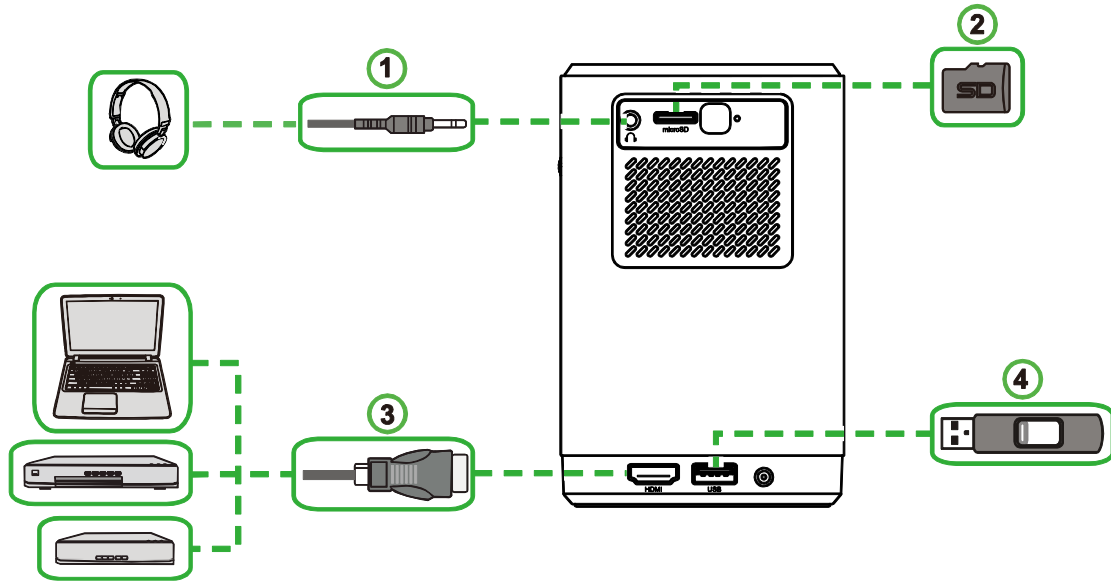

No.	Port	Connection Device	Corresponding Section
1	Audio Out	Headphones	
2	HDMI	Blu-Ray/DVD Players, Set-top Boxes, PCs	Playing from a Video Source (HDMI) on page 27
3	microSD	microSD Card (Media Files)	Playing Video from a Storage Device (USB Flash Drive, microSD Card) on page 20
			Viewing Photos from a Storage Device (USB Flash Drive, microSD Card) on page 22
			Playing Audio from a Storage Device (USB Flash Drive, microSD Card) on page 25
4	USB Type-A	USB Flash Drive (Media Files)	Playing Video from a Storage Device (USB Flash Drive, microSD Card) on page 20
			Viewing Photos from a Storage Device (USB Flash Drive, microSD Card) on page 22
			Playing Audio from a Storage Device (USB Flash Drive, microSD Card) on page 25

USING THE PROJECTOR

Adjusting the Focus

To adjust the focus of the projected image, rotate the dial on the side of the projector until correct focus is achieved.

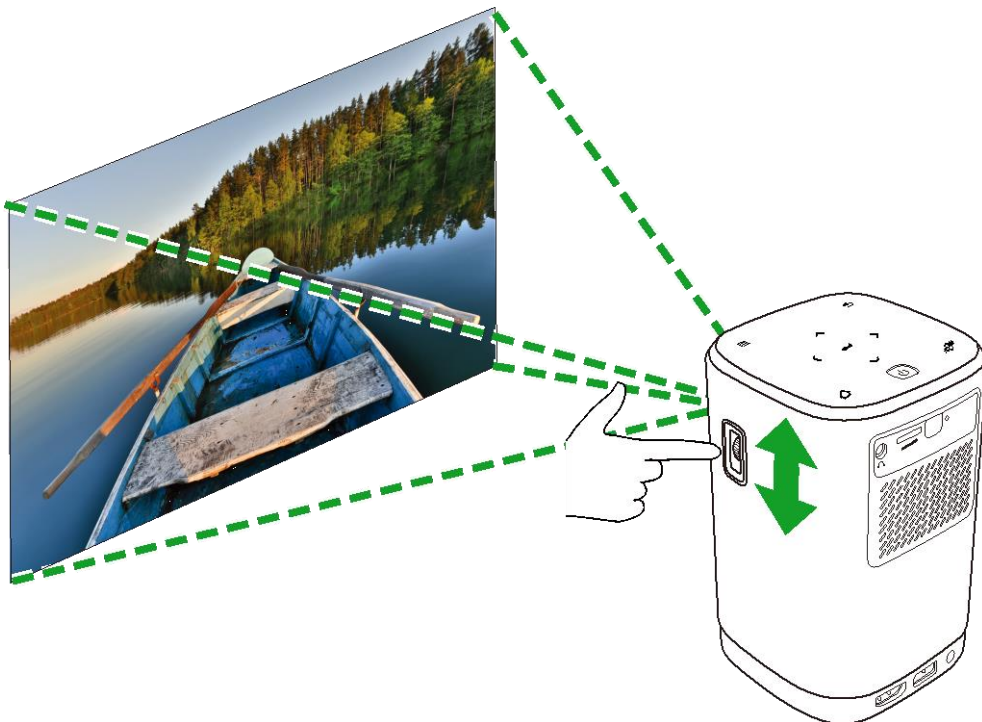
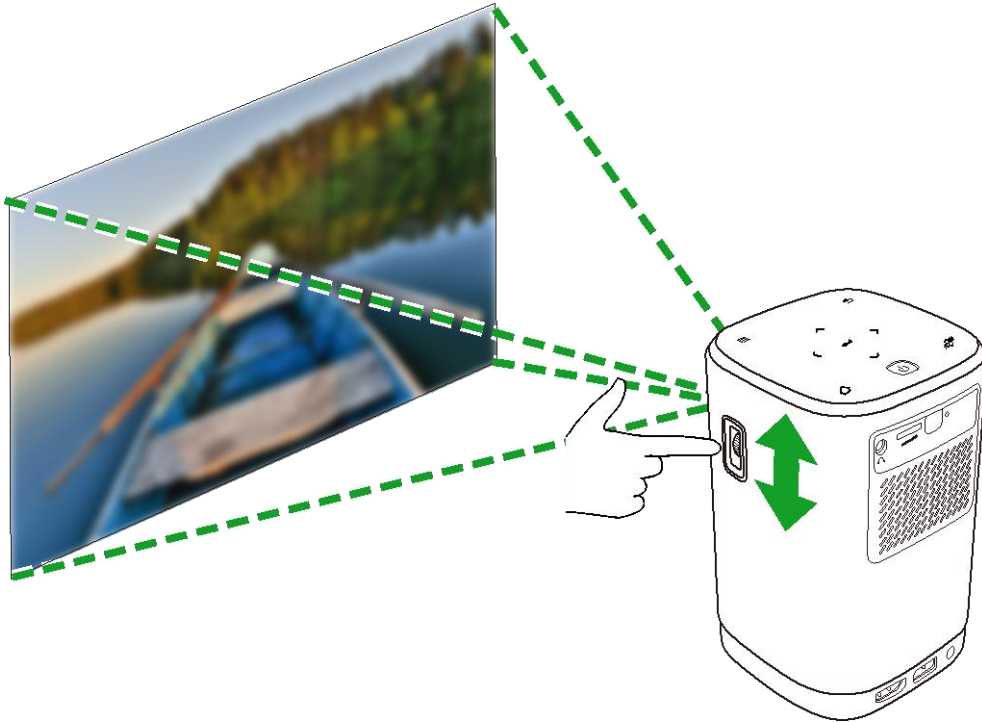



Playing Video from a Storage Device (USB Flash Drive, microSD Card)

To play a video file from a storage device:

1. Connect the device to the projector. Refer to the **Making Connections** section on page **18**.
2. Power on the projector. Refer to the **Powering On/Off the Projector** section on page **16**.



NOTE:

If you are already viewing video or playing music from a different source press the home () or exit () button on the keypad or remote control to return to the home screen.

-
3. Using the keypad or remote control, select **VIDEO** from the home screen and press the enter () button.

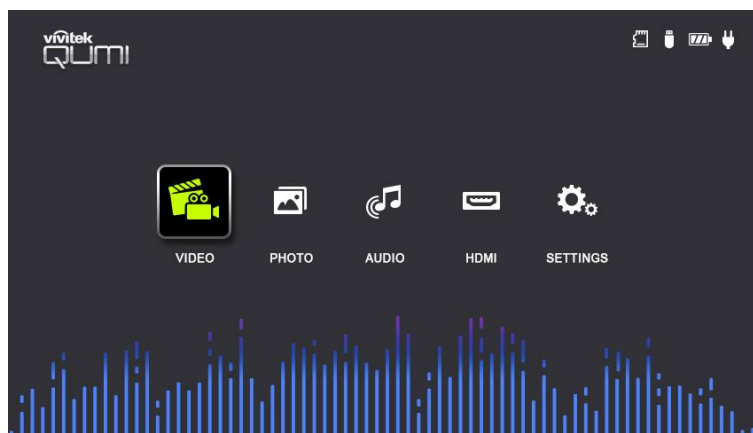

NOTE:

If both a USB flash drive and a microSD card are simultaneously connected to the projector, a menu will appear with both storage options shown. Select the storage media where the video file is located to continue.

-
4. Navigate to the folder where the video is located and press the enter () button.

5. Select the video file you want to play and press the enter ((↵)) button.

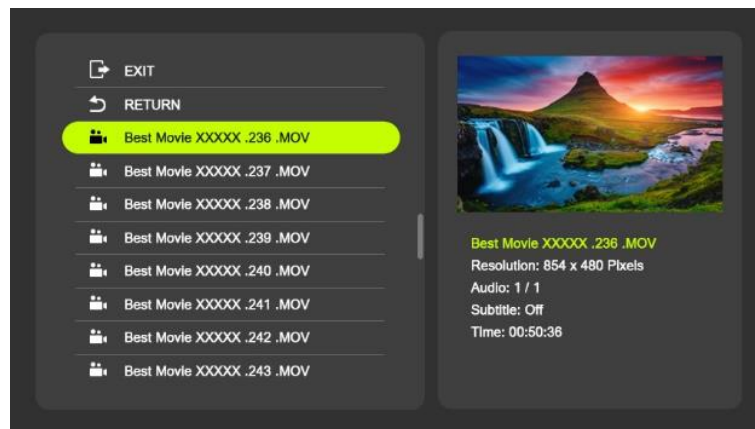



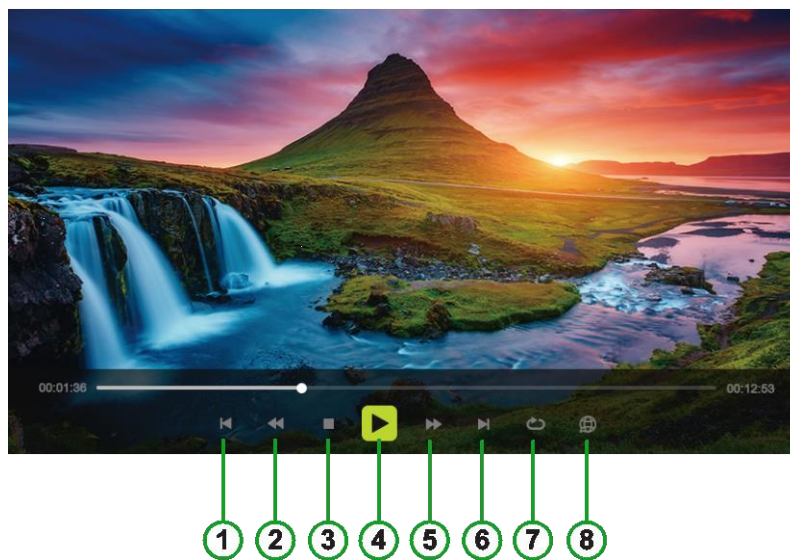

NOTE:

Only the following video formats are supported: AVI, VOB, MOV, MKV, DAT, MPG, MP4.

6. The video will begin playing on the projected screen.



No.	Icon	Function	Description
1		Previous	Select to go to the previous file
2		Rewind	Select to rewind at 2x, 4x, 8x, or 16x speed
3		Stop	Select to stop playing the current video
4		Play / Pause	Select to pause play; Select again to resume play
5		Fast Forward	Select to fast forward at 2x, 4x, 8x, or 16x speed

No.	Icon	Function	Description
6		Next	Select to go to the next file
7		Repeat All	Select to play all the video files in the playlist on a loop
		Repeat One	Select to play a single video file on a loop
		Repeat None	Select to play the current video file one time only
8		More Information	Select to view the more information menu



NOTE:

If you stop playing the video file and select the file again at a later time, a prompt will appear asking you if you want to resume playing from the point where you previously stopped play. Select **Yes** to continue playing.



Viewing Photos from a Storage Device (USB Flash Drive, microSD Card)

To view an image file from a storage device:

1. Connect the device to the projector. Refer to the **Making Connections** section on page **18**.
2. Power on the projector. Refer to the **Powering On/Off the Projector** section on page **16**.



NOTE:

If you are already viewing video or playing music from a different source press the home () or exit () button on the keypad or remote control to return to the home screen.

- Using the keypad or remote control, select **PHOTO** from the home screen and press the enter (↵) button.

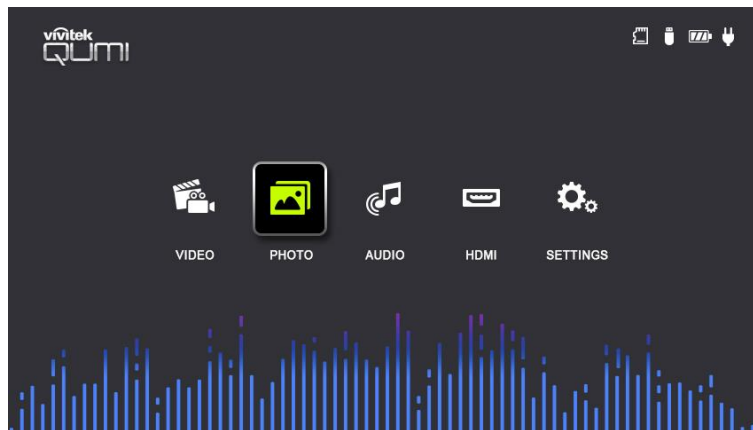

NOTE:

If both a USB flash drive and a microSD card are simultaneously connected to the projector, a menu will appear with both storage options shown. Select the storage media where the image file is located to continue.

- Navigate to the folder where the image is located and press the enter (↵) button.
- Select the image file you want to view and press the enter (↵) button.

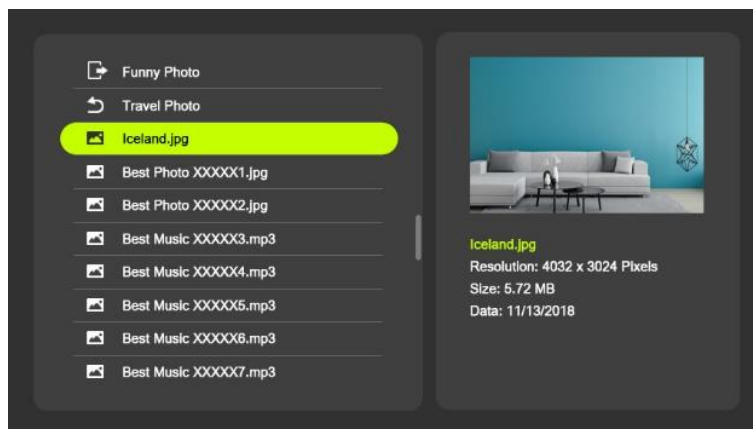

NOTE:

Only the following image formats are supported: JPG, JPEG, BMP, PNG.

- An image slideshow will begin playing on the projected screen starting with the image selected in the previous step.



NOTE:

The slideshow will cycle through all the images in the folder for 5 seconds per image.

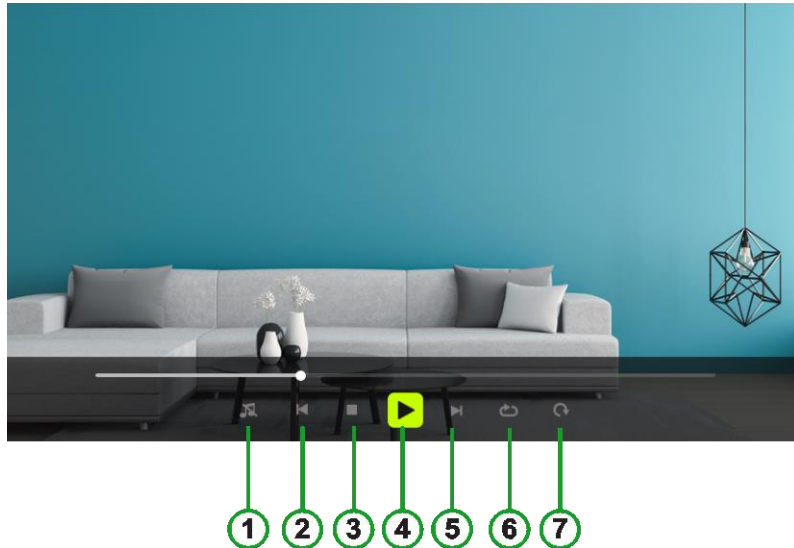

No.	Icon	Function	Description
1		Mute/Unmute Music	Select to mute/play the background music
2		Previous	Select to view the previous image in the slideshow
3		Stop	Select to stop viewing the image and return to the slideshow
4		Play / Pause	Select to pause play; Select again to resume play
5		Next	Select to view the next image in the slideshow
6		Repeat All	Select to play all the image files in the slideshow on a loop
		Repeat One	Select to play a single image file continuously
		Repeat None	Select to play the current image one time only
7		Rotate	Select to rotate the current image clockwise 90-degrees



NOTE:

To play background music during a slideshow, the music file must be located in the same folder in the storage device as the image files.

Playing Audio from a Storage Device (USB Flash Drive, microSD Card)

To play an audio file from Storage Device:

1. Connect the device to the projector. Refer to the **Making Connections** section on page **18**.
2. Power on the projector. Refer to the **Powering On/Off the Projector** section on page **16**.



NOTE:

If you are already viewing video or playing music from a different source press the home (⏠) or exit (⏏) button on the keypad or remote control to return to the home screen.

3. Using the keypad or remote control, select **AUDIO** from the home screen and press the enter (↵) button.

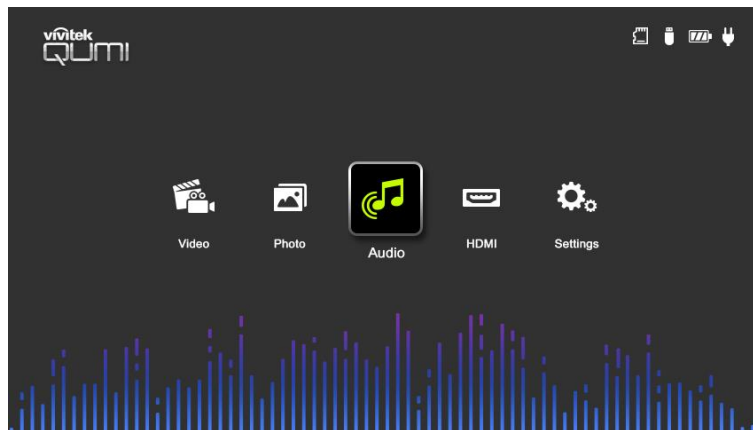

NOTE:

If both a USB flash drive and a microSD card are simultaneously connected to the projector, a menu will appear with both storage options shown. Select the storage media where the music file is located to continue.

4. Navigate to the folder where the audio file is located and press the enter (↵) button.

- Select the audio file you want to play and press the enter (↵) button.

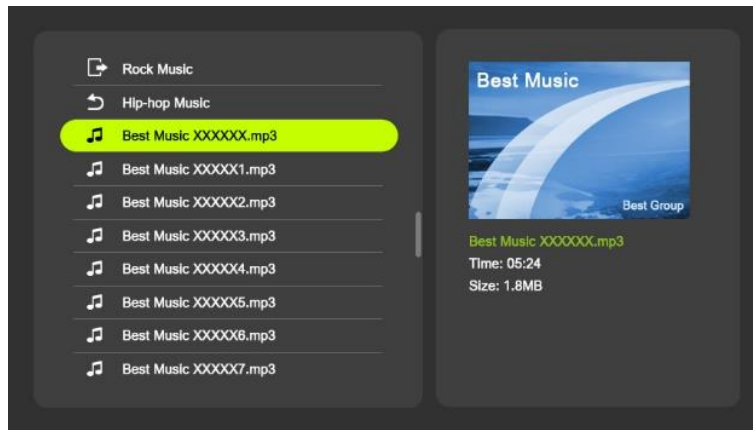

NOTE:

Only the following audio formats are supported: MP3, WMA, M4A, AAC.

- An audio playlist will begin playing on the projected screen starting with the image selected in the previous step.







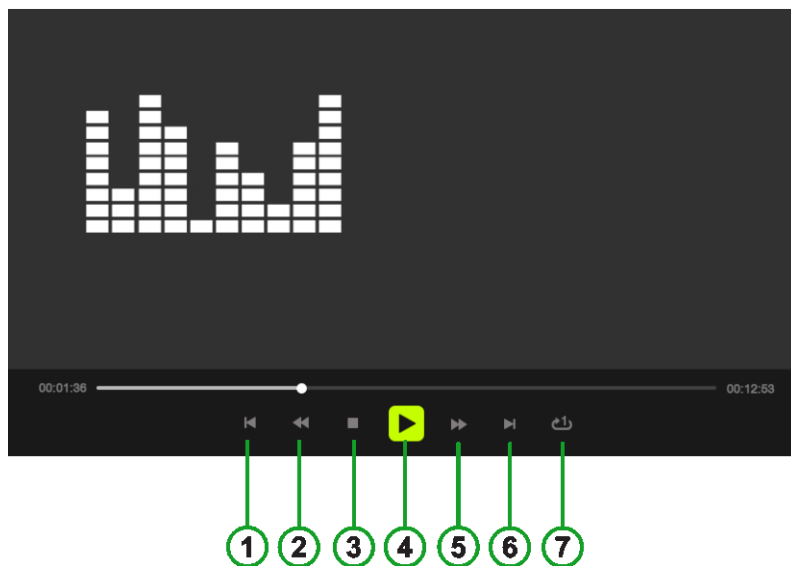

NOTE:

The playlist will begin with the image selected in the previous step, and then cycle through all the songs in the folder.



No.	Icon	Function	Description
1		Previous	Select to play the previous audio file in the playlist
2		Rewind	Select to rewind at 2x, 4x, 8x, or 16x speed

No.	Icon	Function	Description
3		Stop	Select to stop playing the audio file and return to the playlist
4		Play / Pause	Select to pause play; Select again to resume play
5		Fast Forward	Select to fast forward at 2x, 4x, 8x, or 16x speed
6		Next	Select to play the next audio file in the playlist
7		Repeat All	Select to play all the audio files in the playlist on a loop;
		Repeat One	Select to play a single audio file on a loop;
		Repeat None	Select to play the current audio file one time only



Playing from a Video Source (HDMI)

To project a video from a device connected to the HDMI port:

1. Connect the device to the projector. Refer to the **Making Connections** section on page **18**.
2. Power on the projector. Refer to the **Powering On/Off the Projector** section on page **16**.



NOTE:

If you are already viewing video or playing music from a different source press the home () or exit () button on the keypad or remote control to return to the home screen.

3. Using the keypad or remote control, select **HDMI** from the home screen and press the enter () button.

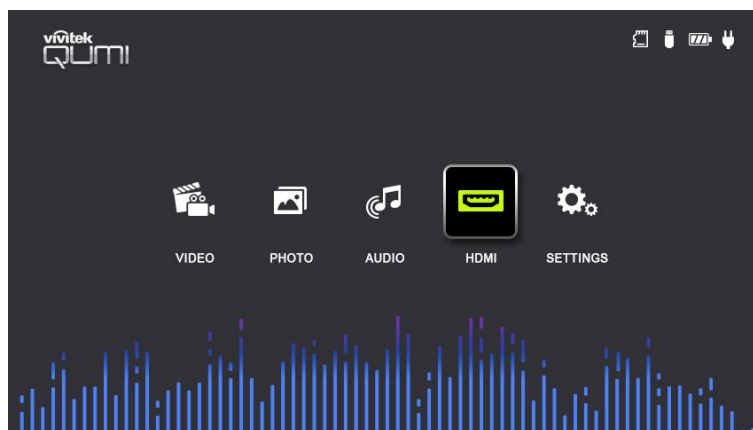

4. The video will automatically be projected onto the screen.

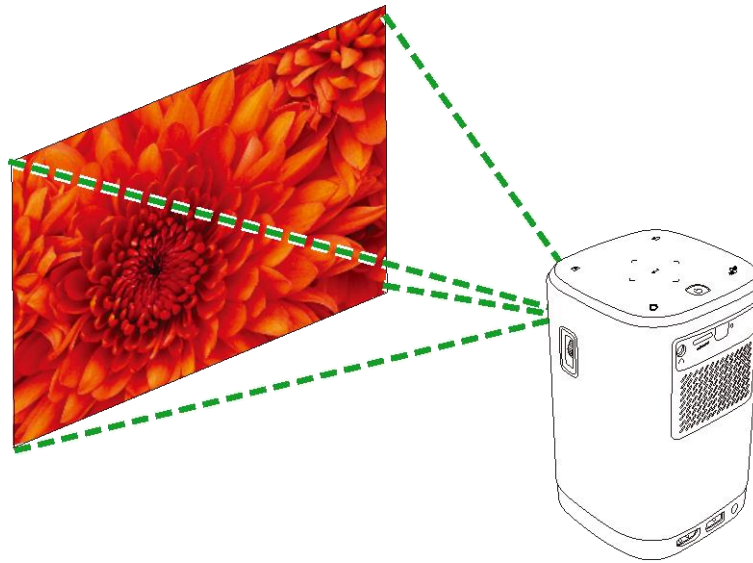

5. To control the video playback use the control options directly from the video source. Press the exit (↩) button on the keypad or remote control to return to the home screen.



NOTE:

Press the enter (↵) button on the keypad or remote control to view information on the video source.

USING THE BLUETOOTH® SPEAKER

You can use Qumi Z1V as a speaker to play music from mobile devices wirelessly via their mobile devices. To use the projector as a speaker:

1. Power on the projector. Refer to the **Powering On/Off the Projector** section on page **16**.
2. Press the Bluetooth® Speaker Mode () button on the keypad or the remote control to enable Bluetooth® on the projector.



3. When activated, the projector lens will turn off and the LED Status Indicator will illuminate blue with behavior based on the following:
 - Solid Blue - Successfully connected.
 - Blinking Blue - Waiting to pair.
 - Breathing Blue - Connection failed, exit Bluetooth® speaker mode and retry again.

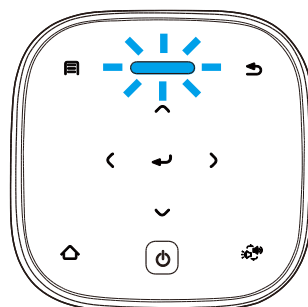

4. Enable Bluetooth® on your mobile device and select Qumi Z1V in your mobile device's Bluetooth® pairing menu.



NOTE:

Once paired your mobile device will automatically connect to the projector. Each subsequent time your mobile device is within range of the projector and Bluetooth® is enabled on both devices they will automatically connect to each other.

5. Play music on your mobile device.

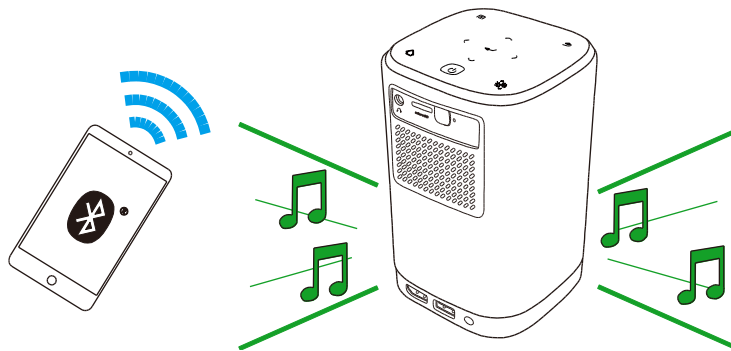

To deactivate Bluetooth® Speaker Mode:

1. Press the Bluetooth® Speaker Mode (🔊) button on the keypad or the remote control.

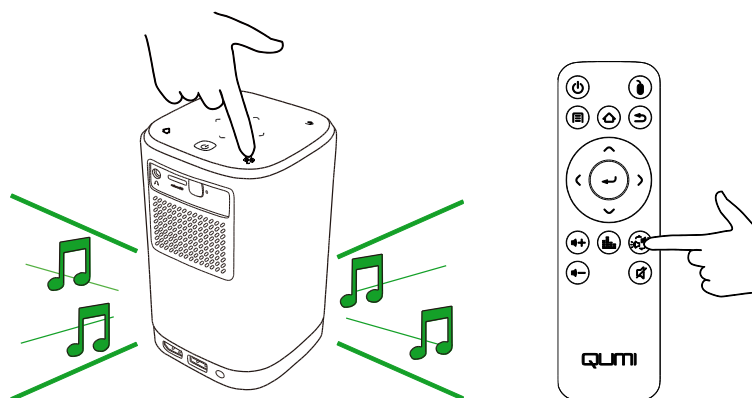

2. When deactivated, the projector lens will turn on and the LED status indicator will no longer illuminate blue.

USING THE SETTINGS MENU

The Settings menu allows the user to adjust display, audio, and other settings for the projector.

To access the Settings menu:

1. Choose one of the following:
 - Press the menu (≡) button on the remote control or the keypad.

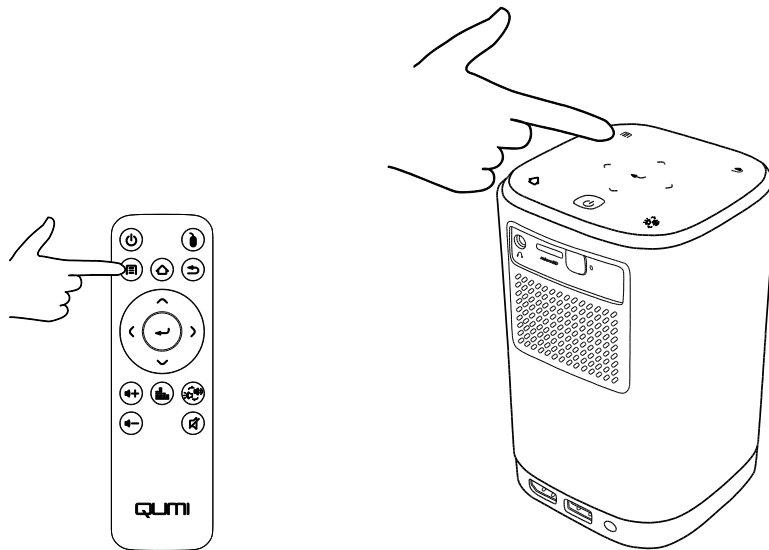

- Select **SETTINGS** from the home screen and press the enter (↵) button.

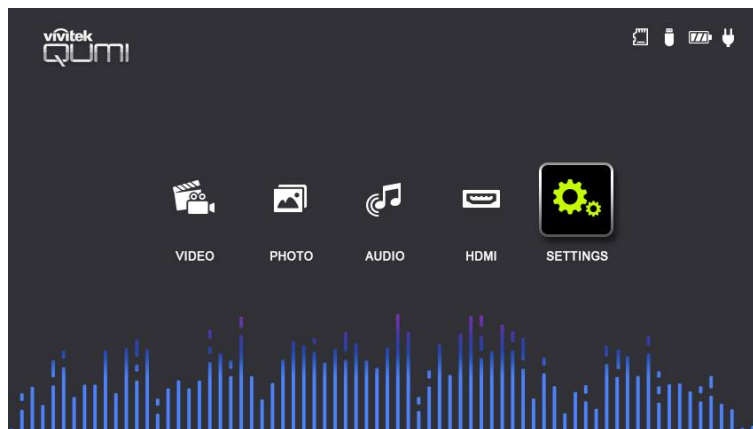

2. The Settings menu will appear on the projected screen.

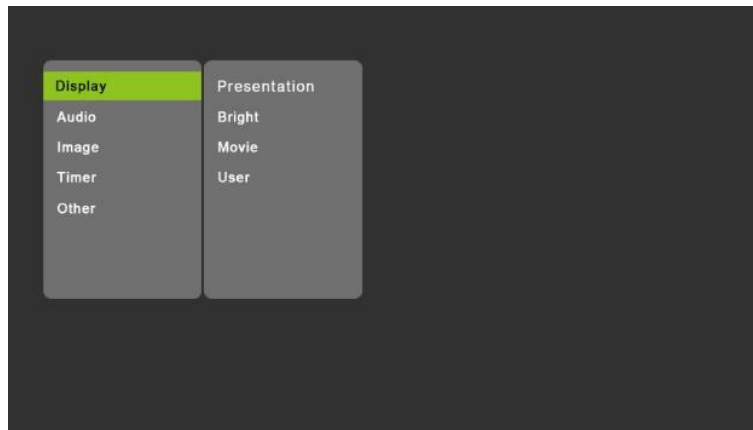

3. Use the following keys on either the remote control or the keypad to navigate the Settings Menu:

- **Up** (^) or **Down** (v) button to navigate to a menu item
- **Enter** (↵) button to select that menu item or sub-menu
- **Exit** (↶) button to return to the previous menu or sub-menu
- **Left** (⏪) or **Right** (⏩) button to change the settings of a menu or sub-menu item

The Settings Menu

DISPLAY SETTINGS

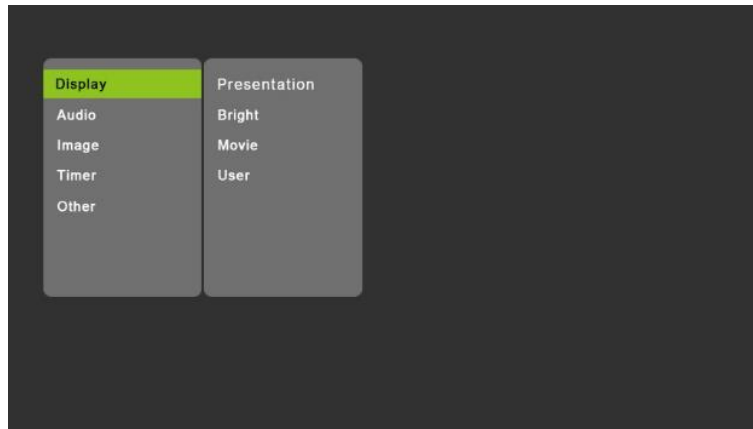

Category	Menu Item	Sub-Menu Item	Description	
Display Mode	Presentation	--	Switches the display settings to pre-defined settings ideal for presentations	
	Bright	--	Switches the display settings to pre-defined settings that maximize brightness	
	Movie	--	Switches the display settings to pre-defined settings ideal for movies	
	User	Contrast		Adjusts the contrast levels
		Brightness		Adjusts the brightness levels
		Color		Adjusts the color values
		Sharpness		Adjusts the sharpness of the image
Tint		Adds a color tint to the image		
Color Temperature		Selects a color temperature profile: User, Cool, Normal or Warm		

AUDIO SETTINGS

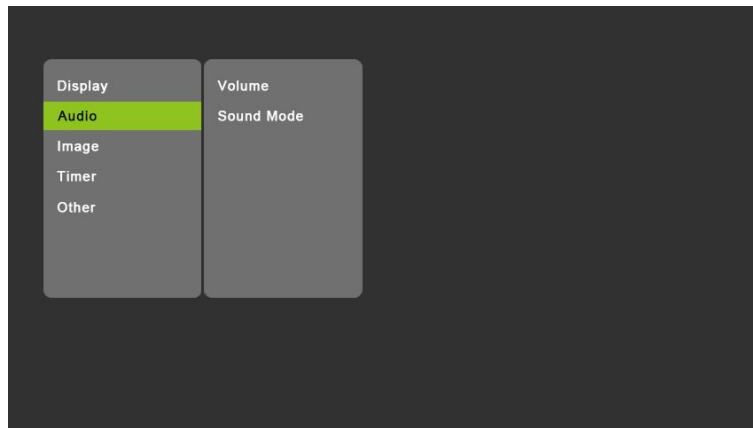

Category	Menu Item	Sub-Menu Item	Description
Audio Settings	Volume	--	Adjusts the volume of the Qumi Z1V
	Sound Mode	Standard	Switches the audio settings to standard pre-defined settings
		Music	Switches the audio settings to pre-defined settings ideal for music
		Movie	Switches the audio settings to pre-defined settings ideal for movies
		User	Adjusts the frequency levels of the audio settings

IMAGE SETTINGS



Category	Menu Item	Sub-Menu Item	Description
Image Settings	Aspect Ratio	--	Sets the aspect ratio to Auto, 4:3, or 16:9
	Auto Keystone	Manual	Allows you to manually adjust the keystone setting
		Auto	Automatically adjusts the keystone setting
	Projection	--	Sets the projector to project from Front, Rear, Front/Ceiling, Rear/Ceiling
	Light Mode	--	Set the light mode to Auto, Standard or Economic

TIMER

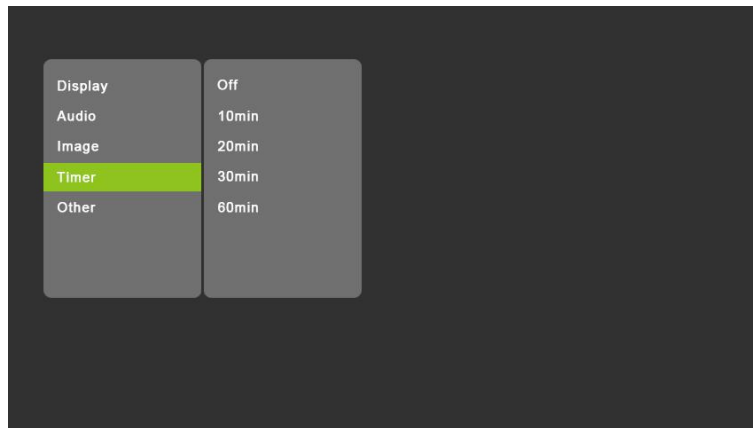

Category	Menu Item	Description
Timer	Timer	Sets a timer that turns off the projector in 10min , 20min , 30min , or 60min .

OTHER SETTINGS

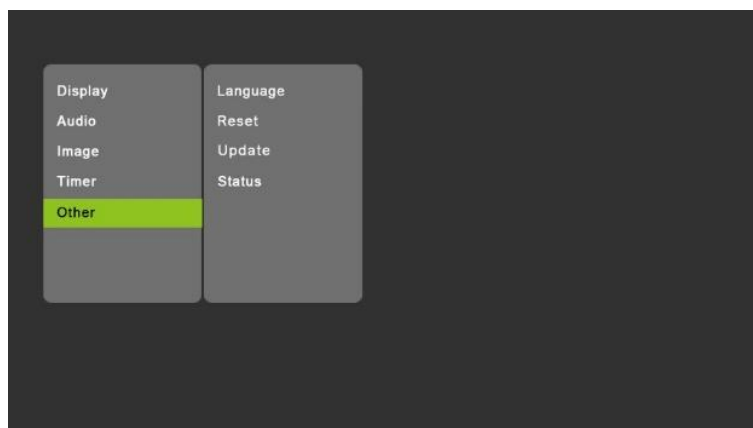

Category	Menu Item	Description
Other Settings	Language	Select a language for the OSD
	Reset All	Resets all the settings to factory defaults
	Update	Allows you to update the software on the projector via a USB flash drive connected to the USB port
	Status	Displays the current Software Version and the LED Hours used for the projector's lamp

TROUBLESHOOTING/FAQ

These guidelines provide tips to deal with problems you may encounter while using Qumi. If the problem remains unresolved, contact your dealer for assistance.

The problem sometimes can be as simple as improper connection of cables. Review the following possible issues before proceeding to the problem-specific solutions.

- Use another electrical device to confirm that the electrical outlet is properly working.
- Make sure that Qumi is turned on.
- Make sure all connections are securely connected.
- Make sure that the connected device is turned on.
- Make sure that the connected PC is not in suspended mode or sleep mode.

Tips

In each problem-specific section, perform the steps in the order suggested. Doing so may help solve the problem more quickly.

In order to avoid replacing non-defective parts, try to find and isolate the problem

For example, if you replace batteries and the problem remains, put the original batteries back and move to the next step.

Keep a record of the steps you take when troubleshooting. The information may be useful for reference when calling technical support or for bringing Qumi to service personnel.

System Reset Method (Reboot)

On the rear side of Qumi next to the IR sensor, there is a small pinhole. Insert a paperclip (or similar sized object) into the hole and press for 3 seconds to reboot Qumi.

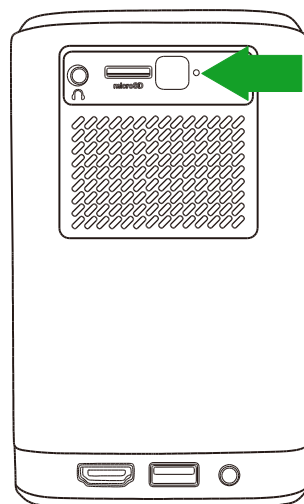

Image Problems

Problem: No image appears on the screen.

1. Check whether the source (PC, Flash Drive, DVD Player, Set-top Box, etc...) is properly configured.
2. Turn off all of the equipment and power up the equipment again in the correct order.

Problem: The image is blurred.

1. Adjust the focus directly via the focus dial on the projector.
2. Ensure that the distance between the Qumi and the screen is within specified range.
3. Clean Qumi lens with optical lens cleaning cloth if it is dirty.

Problem: The image is wider at the top or bottom (trapezoid effect).

1. Position Qumi so that it is as perpendicular to the screen as possible.
2. Adjust the Keystone settings in the Settings menu to correct the problem by either turning Auto Keystone on or by manually adjusting the keystone setting (**Settings > Image > Keystone**).

Problem: The image is reversed.

1. Check the image orientation of the Projector in the Settings menu (**Settings > Image > Projection**).

Remote Control Problems

Problem: Qumi does not respond to the remote control commands.

1. Aim the remote control towards the front or rear sensor on the Qumi.
2. Make sure the path between remote and sensor is not obstructed.
3. Turn off any fluorescent lights in the room.
4. Check to see if the battery polarity is correct.
5. Replace the batteries.
6. Turn off other infrared-enabled devices in the vicinity.
7. Have the remote control serviced.

Problem: The remote control's power button does not turn on the Qumi.

1. Make sure that the Qumi is using the power adapter.

Audio Problems

Problem: There is no sound.

1. Adjust the volume on the audio source.
2. Test the output of the audio source with other speakers.
3. If using Bluetooth, ensure that Qumi is in Bluetooth mode on and ensure that pairing has occurred.
4. Have Qumi serviced.

Problem: The sound is unstable in Bluetooth speaker mode

1. Check to make sure that Qumi is within range of your Bluetooth device (Smartphone, Tablet, etc.).
2. Use another Bluetooth speaker to test the output of the audio source.
3. Have Qumi serviced.

FAQs

1. **Is it possible to connect Qumi to a game console, such as a Microsoft® Xbox or Sony® Playstation?**

Yes, Qumi can be used to display content from an Xbox or Playstation console. This can be done by connecting the HDMI cable from the game console to Qumi.

2. **Can Qumi project content from a television?**

Watching television content can be done by connecting a cable box, digital set-top box or satellite receiver directly to Qumi. For example, if a cable box is used, it can be connected by an HDMI cable to Qumi.

3. **How are images from a USB storage device displayed?**

Images and other content can be displayed by connecting the following devices to Qumi:

- USB flash drive
- microSD card

Once the devices are connected, images can be displayed by using the Qumi Photo Player.

4. **Which cable is required for video devices to be connected with Qumi?**

Video devices can be connected to Qumi by using an HDMI cable if the video devices contain an HDMI appropriate output port.

5. **What type of video formats does Qumi support?**

AVI//VOB/MOV/MKV/DAT/MPG/MP4

6. **What type of audio formats does Qumi support?**

MP3/WMA/M4A/AAC

7. **What type of photo formats does Qumi support?**

JPG/JPEG/BMP/PNG

8. **What type of document formats does Qumi support?**

Qumi does not support document playback (Example: Microsoft® Office, Adobe® PDF or TXT).

9. **How long will the LED light source in Qumi last and can it be replaced?**

Qumi does not use a typical light source. It uses a set of Light Emitting Diodes (LED) to illuminate and project images. LED's have a greater lifespan than conventional lamps. The Qumi's LED is estimated to last for approximately 30,000 hours. The lifespan of the LED depends on factors such as brightness, usage, environmental conditions. LED brightness can decrease over time. The LED module is not replaceable.

10. **Why do I need to re-adjust the focus on my Qumi after it's powered up?**

For the best picture quality, adjustment of the projector's Focus-Dial may be necessary once the operational temperature has been met.

11. **I've lost my remote. Where can I get a replacement?**

Contact your Reseller or Vivitek Service via www.vivitekcorp.com (select region) to obtain a replacement remote (Charges may be applied).

12. **Why won't Qumi recognize my USB flash drive?**

The USB flash drive must be formatted in FAT32, FAT16 or NTFS.

13. **Bluetooth doesn't work with my BT device (Example: keyboard, mouse or other similar device)?**

Qumi's Bluetooth function is only for audio playback between a smartphone, tablet or other BT enabled audio device.

14. **Why won't the remote control's Power On button switch on the Qumi?**

When the projector is off and not attached to the power adapter, the remote control doesn't support "Power On". Once the power adapter is connected, the remote control's "Power On" feature will function normally.

Vivitek Support Site

Please visit www.vivitekcorp.com and select your region for more information, support and product registration.

ADDITIONAL INFORMATION

Projection Distance vs Projection Size

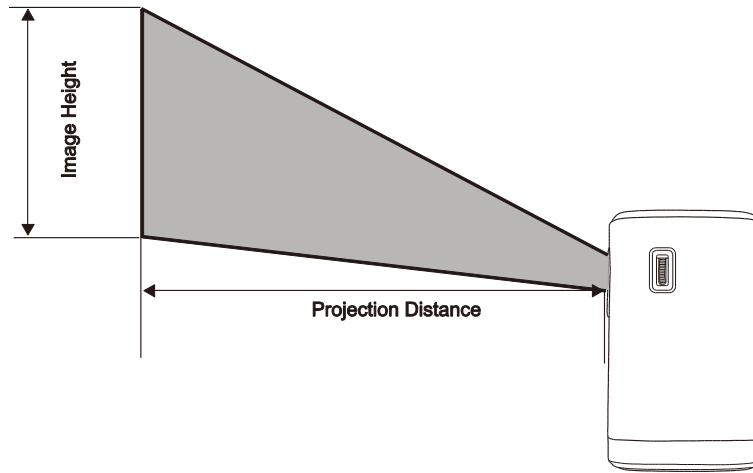

Image Diagonal (cm/inch)	Image Width (cm/inch)	Image Height (cm/inch)	Projection Distance (cm/inch)
39.3/15.5	33.3/13.1	20.8/8.2	40/15.8
59.0/23.6	50.0/19.7	31.2/12.3	60/23.6
78.6/31.0	66.7/26.2	41.7/16.4	80/31.5
98.3/38.7	83.3/32.8	52.1/20.5	100/39.4
117.9/46.4	100.0/39.4	62.5/24.6	120/47.2
137.6/54.2	116.7/45.9	72.9/28.7	140/55.1
157.2/61.9	133.3/52.5	83.3/32.8	160/63.0
176.9/69.6	150.0/59.1	93.7/36.9	180/70.9
196.5/77.4	166.7/65.6	104.2/41.0	200/78.7



NOTE:

The offset table has a 10% tolerance due to optical component variations.

Timing Mode Table

Resolution	Horizontal Synchronization [KHz]	Vertical Synchronization [HZ]
VESA640x480_60	31.47	59.94
VESA640x480_72	37.86	72.81
VESA640x480_75	37.5	75
VESA800x600_60	37.88	60.32
VESA800x600_72	48.08	72.19
VESA800x600_75	46.88	75
VESA1024x768_60	48.36	60
VESA1024x768_70	56.48	70.07
VESA1024x768_75	60.02	75.03
VESA1280x768_60-RB	47.4	59.99
VESA1280x768_60	47.78	59.87
VESA1280x800_60	49.7	59.81
VESA1280x800_75	62.79	74.93
VESA1280x1024_60	63.98	60.02
VESA1280x1024_75	79.98	75.02
VESA1280x960_60	60	60
VESA1400x1050_60	65.32	59.98
VESA1440x900_60	55.93	59.89
VESA1600x1200_60	75	60
VESA1680x1050_60-RB	64.67	59.88
VESA1680x1050_60	65.29	59.95
VESA1920x1080_60	67.5	60
VESA1920x1200_60-RB	74.04	59.95
IBM-720x400-70	31.467	70.08
MAC-640x480-66	35	66.67
MAC-832x624-75	49.722	74.55
MAC-1024x768-60	48.773	59.99
MAC-1152x870-75	68.681	75.06
854 x 480	31.8	60.6
SDTV-480i60	15.734	59.94
SDTV-480P59	31.469	59.394
SDTV-576i50	15.625	50
SDTV-576P50	31.25	50
HDTV-720P50	37.5	50
HDTV-720P60	45	60
HDTV-1080i50	28.125	50
HDTV-1080i60	33.75	60
HDTV-1080p24	27	24
HDTV-1080p25	28.13	25
HDTV-1080P30	33.75	30
HDTV-1080P50	56.25	50
HDTV-1080P60	67.5	60

Specifications

Model No.:	Z1V
Native Resolution	WVGA (854 x 480)
Maximum Resolution	1080p (1920 x 1080)
Throw Ratio (Distance/Width)	1.2:1 (Manual Adjustment Focus)
Image Size (Diagonal)	0.5m - 1.9m (19.7" - 75")
Projection Distance	0.5m - 2.0m (1.6ft - 6.6ft)
Aspect Ratio	16:9 Native
Keystone Correction	Vertical $\pm 30^\circ$ (Auto Keystone)
Bluetooth® Audio	Yes (Bluetooth® 4.0)
Storage Expansion	Yes (microSD, USB Flash Drive)
Multiple Media Player	Yes (Video, Image, Audio)
Speakers	5W (x2) (Stereo)
Tripod Mount	Yes (Standard 1/4-20 L6.3 mm camera mount hole)
I/O Connection Ports	HDMI v1.4b, Earphone-Out (3.5mm), USB Type A (5V/0.5A), microSD Card Slot
Battery Type (Embedded)	4,000 mAh (7.4V) (29.6Wh) Li-Polymer Rechargeable Battery (Up to 2 hours of usage)
Operating Temperature	5°C to 35°C (41°F to 95°F)
Power Supply	AC 100-240V, 50/60Hz
Power Consumption	36W (Normal Mode)
Projection Method	Table Top, Ceiling Mount (Front or Rear)
Dimensions (W x D x H)	86 x 86 x 136mm (3.4" x 3.4" x 5.1")

Adapter Specifications

Model No.:	ADP-36PH A
Manufacturer	Delta Electronics, Inc
Rating	Input: 100-240V~, 1A, 50-60Hz Output: 12Vdc, 3A
Operating Temperature	0°C to 40°C (32°F to 104°F)



Vivitek Americas

46101 Fremont Blvd,
Fremont, CA 94538
U.S.A.
T: +1-510-668-5100
F: +1-510-668-0680

Vivitek Asia

7F, No. 186, Ruey Kuang Road,
Neihu, Taipei 11491
Taiwan R.O.C.
T: +886-2-8797-2088
F: +886-2-6600-2358

Vivitek Europe

Zandsteen 15, 2132 MZ Hoofddorp
The Netherlands
T: +31-20-800-3960
F: +31-20-655-0999
www.vivitekc.com

A brand of  **DELTA**