

Canon

MACRO TWIN LITE MT-26EX-RT



**INSTRUCTION
MANUAL**

Introduction

The Canon Macro Twin Lite MT-26EX-RT is a flash unit for shooting close-ups with Canon EOS cameras, compatible with E-TTL II/E-TTL autoflash systems. The flash unit is equipped with various functions suitable for a wide range of shooting objectives, from simple shooting to advanced shooting. It has functions to control the flash ratio between flash heads A and B, single-side firing, radio/optical transmission wireless multiple flash photography using additional slave flash units, and manual flash.

Before Starting to Shoot, Be Sure to Read the Following

To avoid botched pictures and accidents, first read the “Safety Instructions” (pages 8-9). Also, read this manual carefully to ensure that you use the product correctly.

Read This Instruction Manual while also Referring to Your Camera’s Instruction Manual

Before using the product, read this Instruction Manual and your camera’s Instruction Manual to familiarize yourself with their operations. Be sure to store this manual safely, too, so that you can refer to it again when necessary.

Using the MT-26EX-RT with a Camera

- **Using with an EOS DIGITAL camera (Type-A camera)**

You can use the MT-26EX-RT for easy macro flash photography using autoflash control in the same way as a camera’s built-in flash.

- **Using with an EOS film camera**

- **An EOS camera with E-TTL II/E-TTL autoflash metering system (Type-A camera)**

You can use the MT-26EX-RT for easy macro flash photography using autoflash control in the same way as a camera’s built-in flash.

- **An EOS camera with TTL autoflash metering system (Type-B camera)**

See page 121.









* This Instruction Manual assumes that the MT-26EX-RT is used with a Type-A camera.

Chapters

	Introduction	2
1	Getting Started with Macro Flash Photography Preparing for macro flash photography and basic shooting operations	17
2	Setting Flash Functions with Camera Controls Setting the flash functions from the camera's menu screen	51
3	Radio Transmission Wireless Multiple Flash Photography Wireless multiple flash shooting by radio transmission	57
4	Optical Transmission Wireless Multiple Flash Photography Wireless multiple flash shooting by optical transmission	81
5	Customizing the MT-26EX-RT Customizing with Custom Functions and Personal Functions	97
6	Reference System map, troubleshooting guide, using with a type-B camera	107

Conventions Used in this Manual

Icons in this Manual

-  : Indicates the Select dial.
-  : Indicates the Select/Set button.
-  /  /  : Indicates that the respective function remains active for approx. 4 sec., 6 sec., 8 sec., 10 sec., or 16 sec. after you let go of the button.
-  /  : Indicates that the respective function remains active for approx. 10 sec. or 16 sec. after you let go of the button.
- (p.**): Reference page numbers for more information.
-  : Warning to prevent shooting problems.
-  : Supplemental information.
- ☆ : ☆ shown on the upper right of the page title indicates that the function is performed when the camera's shooting mode is set to <P/Tv/Av/M/bulb(B)> (Creative Zone mode).







Basic Assumptions

- The operation procedures assume that the MT-26EX-RT is attached to the camera and that both are turned on.
- The icons used for buttons, dials, and symbols in the text match the icons found on the MT-26EX-RT and the camera.
- The selection operation performed when setting a function basically describes selecting a function by turning <⊙>.
- When <⏪> is displayed at the Function button 4 position, the screen returns to the previous screen by pressing <⏪>.
- The operation procedures assume that the Custom Functions and Personal Functions of the MT-26EX-RT, and the menu and Custom Functions of the camera are at their default settings.
- All figures such as the number of flashes are based on the use of four AA/LR6 alkaline batteries and Canon's testing standards.
- The operation procedures assume that a macro lens is used.

Contents

Introduction	2
Chapters	3
Conventions Used in this Manual	4
Index to Features	7
Safety Instructions	8
Nomenclature.....	10

1 Getting Started with Macro Flash Photography **17**

Installing the Batteries.....	18
Attaching and Detaching the Control Unit to and from the Camera	20
Attaching and Detaching the Flash Unit to the Lens.....	21
Adjusting the Flash Unit.....	22
Turning on the Power.....	27
ETTL : Fully Automatic Flash Photography.....	30
E-TTL II/E-TTL Autoflash by Shooting Mode.....	32
Effective Flash Metering Range.....	35
 Combined Use with the Diffuser Adapter	36
 Setting the Flash Ratio	38
 Flash Exposure Compensation	40
 FEB.....	41
FEL: FE Lock.....	42
 High-speed Sync.....	43
 Second-curtain Sync.....	44
M : Manual Flash.....	45
Clearing MT-26EX-RT Settings	49

2 Setting Flash Functions with Camera Controls **51**

Flash Control from the Camera's Menu Screen.....	52
--	----

3	Radio Transmission Wireless Multiple Flash Photography	57
	(☑) Radio Transmission Wireless Multiple Flash Photography	58
	Radio Transmission Wireless Settings	64
	ETTL : Multiple Flash Photography with Slave C Added	69
	ETTL : Advanced Multiple Flash Photography with Slaves A, B, and C Added	74
	M : Multiple Flash Photography with Manual Flash Output	76
	Gr : Shooting in a Different Flash Mode for Each Group	78
4	Optical Transmission Wireless Multiple Flash Photography	81
	🚩 Optical Transmission Wireless Multiple Flash Photography	82
	Optical Transmission Wireless Settings	85
	ETTL : Multiple Flash Photography with Slave C Added	88
	ETTL : Advanced Multiple Flash Photography with Slaves A, B, and C Added	92
	M : Wireless Multiple Flash Photography with Manual Flash Output.....	94
5	Customizing the MT-26EX-RT	97
	C.Fn / P.Fn : Setting Custom and Personal Functions.....	98
	C.Fn : Setting Custom Functions.....	101
	P.Fn : Setting Personal Functions.....	104
6	Reference	107
	MT-26EX-RT System	108
	🚫 Flash Firing Restrictions due to Temperature Increase	110
	Troubleshooting Guide	112
	Specifications	116
	Using with a Type-B Camera	121
	Radio Transmission Wireless Function	122
	Index.....	125

Index to Features

Power Source

- Batteries → p.18
- Firing interval/count → p.18
- Power ON/OFF → p.27
- Flash ready → p.27
- Quick flash → p.27
- Auto power off → p.28

Operations

- Attaching and detaching the MT-26EX-RT → p.20, p.21
- Lock function → p.28
- LCD panel illumination → p.29

Normal Flash Photography

- Full auto (E-TTL) → p.30
- Autoflash by shooting mode → p.32
- Manual flash → p.45
- Metered manual flash → p.48

Function

- Modeling flash → p.34
- Diffuser adapter → p.36
- Flash exposure compensation → p.40
- FEB → p.41

- FE lock → p.42
- High-speed sync → p.43
- Second-curtain sync → p.44
- Clearing settings (Reverting to defaults) → p.49
- Flash function settings → p.51
- Flash firing restriction → p.110
- Type-B camera → p.121

Radio Transmission Wireless Photography

- Remote release → p.67
- Memory function → p.68
- Manual flash → p.76
- Group flash → p.78

Optical Transmission Wireless Photography

- Memory function → p.87
- Manual flash → p.94

Customization

- Clear all → p.100
- Custom Functions (C.Fn) → p.101
- Personal Functions (P.Fn) → p.104

Safety Instructions

Be sure to read these instructions in order to operate the product safely. Follow these instructions to prevent injury or harm to the operator of the product or others.



WARNING: Denotes the risk of serious injury or death.

- Keep the product out of the reach of young children.

A strap or cord wrapped around a person's neck may result in strangulation. The battery is dangerous if swallowed. If swallowed, seek immediate medical assistance.

- Use only power sources specified in this instruction manual for use with the product.
- Do not disassemble or modify the product.
- Do not expose the product to strong shocks or vibration.
- Do not touch any exposed internal parts.
- Stop using the product in any case of unusual circumstances such as the presence of smoke or a strange smell.
- Do not use organic solvents such as alcohol, benzene or paint thinner to clean the product.
- Do not get the product wet. Do not insert foreign objects or liquids into the product.
- Do not use the product where flammable gases may be present.

This may cause electric shock, explosion or fire.

- Observe the following instructions when using commercially available batteries or provided battery packs.
 - Use batteries/battery packs only with their specified product.
 - Do not heat batteries or expose them to fire.
 - Do not charge batteries/battery packs using non-authorized battery chargers.
 - Do not expose the terminals to dirt or let them come into contact with metallic pins or other metal objects.
 - Do not use leaking batteries/battery packs.
 - When disposing of batteries/battery packs, insulate the terminals with tape or other means.

This may cause electric shock, explosion or fire.

If a battery/battery pack leaks and the material contacts your skin or clothing, flush the exposed area thoroughly with running water. In case of eye contact, flush thoroughly with copious amounts of clean running water and seek immediate medical assistance.

- Do not allow the product to maintain contact with the same area of skin for extended periods of time during use.

This may result in low-temperature contact burns, including skin redness and blistering, even if the product does not feel hot. The use of a tripod or similar equipment is recommended when using the product in hot places and for people with circulation problems or less sensitive skin.

- Follow any indications to turn off the product in places where its use is forbidden. Not doing so may cause other equipment to malfunction due to the effect of electromagnetic waves and even result in accidents.
- To prevent fire, excessive heat, chemical leakage, explosions, and electrical shock, follow the safeguards below:
 - Do not insert the battery's plus and minus ends incorrectly.
- Do not fire the flash at anyone driving a car or other vehicle. It may cause an accident.
- Do not use or store the equipment in dusty or humid places. This is to prevent fire, excessive heat, electrical shock, and burns.

**CAUTION: Denotes the risk of injury.**

- Do not fire the flash near the eyes. It may hurt the eyes.
- Flash emits high temperatures when fired. Keep fingers, any other part of your body, and objects away from the flash unit while taking pictures. This may cause burns or malfunction of the flash.
- Do not leave the product in places exposed to extremely high or low temperatures. The product may become extremely hot/cold and cause burns or injury when touched.
- Do not touch any parts inside the product. This may cause injury.
- When the product is not in use for a prolonged period, make sure to remove the batteries before storing. This is to prevent malfunction or corrosion.
- Be careful when you replace the batteries after continually firing. The batteries may be hot and it may cause a skin burn.

Nomenclature

Flash Unit

Flash Unit

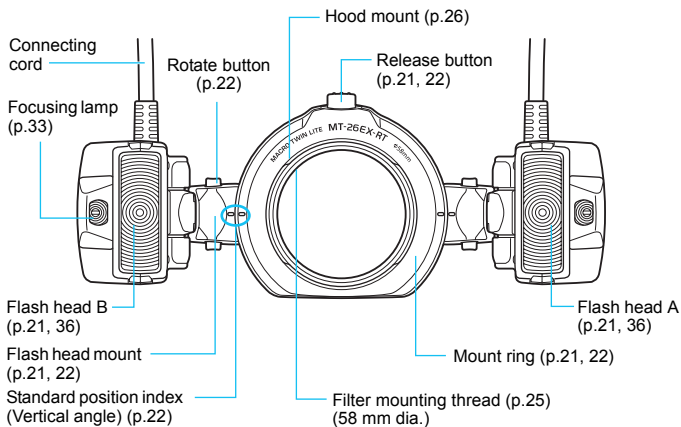

Flash Unit Rear

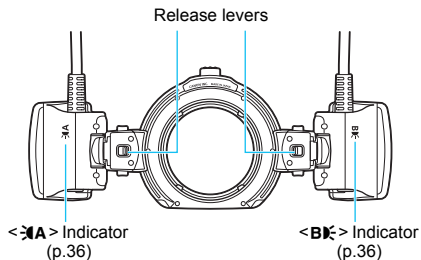

Flash Head Side & Bottom

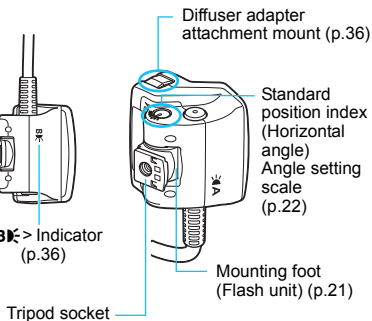

Control Unit

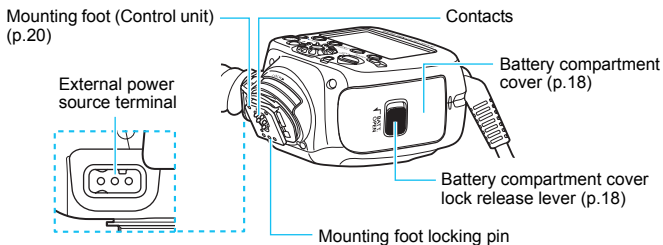
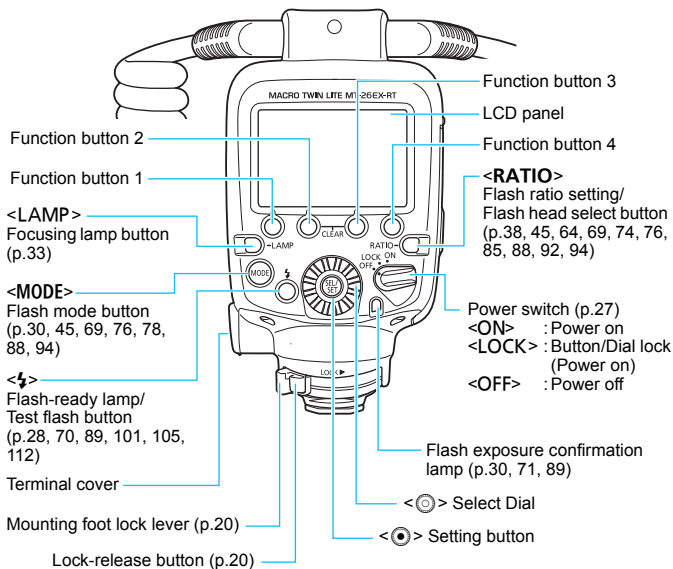

LCD Panel

● E-TTL II/E-TTL Autoflash (p.30)

CHARGE : Charge indicator (p.27)

ETTL : E-TTL II/E-TTL autoflash

Diffuser adapter (p.36)

: Attached to A

: Attached to B

: Attached to A, B

: Flash exposure compensation (p.40, 55)

Flash exposure compensation amount

: High-speed sync (p.43, 55)

: Second-curtain sync (p.44, 55)

P.Fn : Personal Functions (p.98, 101)

C.Fn : Custom Functions (p.98, 104)

P/C.Fn : Personal/Custom Functions

Flash exposure level

Aperture

FEB sequence (p.102)

: FEB (p.41, 55)

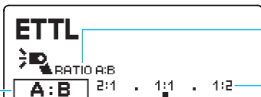
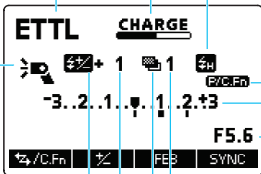

RATIO : Flash ratio setting (p.38)

Firing group

Flash ratio

A:B : Fire A:B (flash ratio control)

A : Fire A (single-side firing)

B : Fire B (single-side firing)

● Manual Flash (p.45)

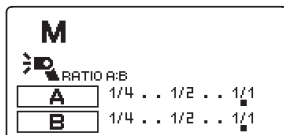

- The displays shown are examples. The display will show only the conditions currently applied.
- The functions displayed above function buttons 1 to 4, such as and , change according to the setting status.
- When a button or dial is operated, the LCD panel illuminates (p.29).

● Radio Transmission Wireless Multiple Flash Photography (p.57)

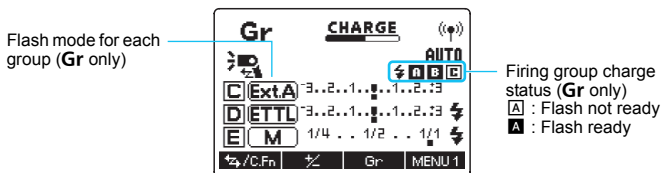
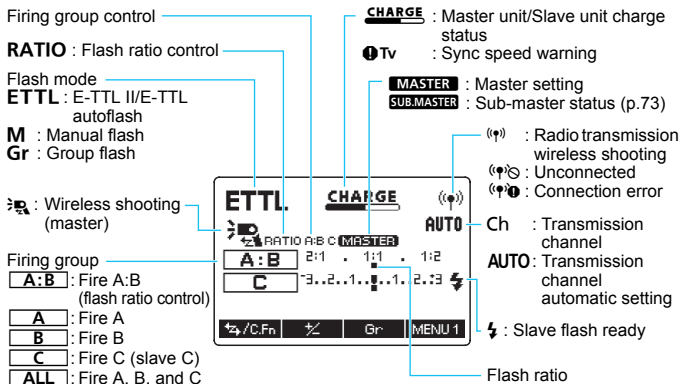

During radio transmission wireless multiple flash shooting, when the master unit and slave unit are fully charged, < **CHARGE** > disappears. Also, during < **Gr** > flash shooting, when all flash units are fully charged, the “firing group charge status” indication also disappears.

● Optical Transmission Wireless Multiple Flash Photography (p.81)

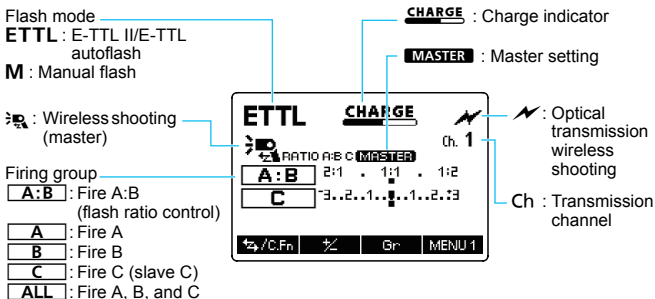

Provided Accessories

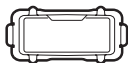
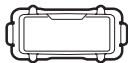
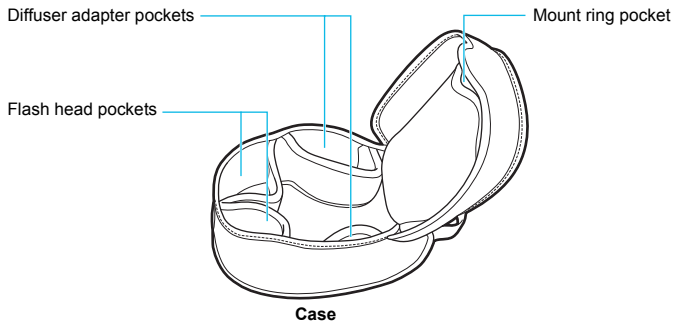

**Diffuser adapter
SDA-E1
(p.36)**

1

Getting Started with Macro Flash Photography

This chapter describes the preparations before starting macro flash photography and the basic shooting operations.

Cautions for firing continuous flash

- To avoid degrading and damaging the flash unit due to overheating, limit the continuous firing at full output to 20 times or less. After continuously firing the flash 20 times, allow a rest time of at least 10 min.
- If you fire the flash continuously 48 times and then fire the flash again repeatedly at short intervals, the safety function may activate and restrict flash firing. With flash firing restriction, the firing interval is automatically set to approx. 8-20 sec. If this happens, allow a rest time of at least 25 min.
- For details, see “Flash Firing Restrictions due to Temperature Increase” on page 110.

 Conditions of the subject greatly influence the exposure when shooting close-ups. Therefore, it is recommended to shoot the same subject with different exposures (p.40) and check the exposure after shooting.

Installing the Batteries

Install four AA/R6 batteries for power supply.

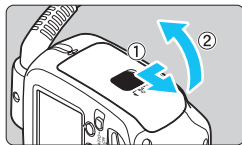

1 Open the cover.

- Slide the lock-release lever to the left as shown in the illustration, slide the cover down, then open the battery compartment cover.

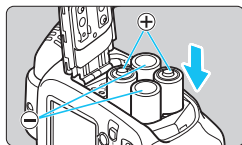

2 Install the batteries.

- Make sure the “+” and “-” electrical contacts are correctly oriented as shown in the battery compartment.
- The grooves on the side surfaces of the battery compartment indicate “-”. This is convenient when replacing the batteries in a dark place.

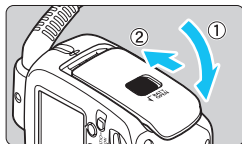

3 Close the cover.

- Close the battery compartment cover and slide it up.
- ▶ When it clicks in place, the battery compartment cover is locked.

Firing Interval and Number of Flashes

- MT-26EX-RT alone

Firing Interval		Number of Flashes
Quick Flash	Normal Flash	
Approx. 0.1-3.3 seconds	Approx. 0.1 - 5.5 seconds	Approx. 100 - 700 times

- Based on new AA/LR6 alkaline batteries, both-sides firing, and Canon's testing standards.
- The Quick flash function enables flash photography before the flash is fully charged (p.27).

 **CAUTION**

- **Do not use “AA/R6 lithium batteries”.**

Note that certain “AA/R6 lithium batteries” may become extremely hot in rare cases during use. Due to safety reasons, do not use “AA/R6 lithium batteries”.

- **When performing continuous flash, do not touch the flash unit, batteries, or the area near the battery compartment.**

When continuous flash or modeling flash is repeatedly fired at short intervals, do not touch the flash unit, batteries, or the area near the battery compartment. The flash unit, batteries, and area near the battery compartment may become hot, resulting in the risk of burn.

- **Do not allow the product to maintain contact with the same area of skin for extended periods of time during use.**

This may result in low-temperature contact burns, including skin redness and blistering, even if the product does not feel hot. The use of a tripod or similar equipment is recommended when using the product in hot places and for people with circulation problems or less sensitive skin.



- Using AA/R6 batteries other than the alkaline type may cause contact failure because their battery contact shapes are not standardized.
- When using the Compact Battery Pack CP-E4N (sold separately, p.109), also refer to the CP-E4N Instruction Manual.



- When  is displayed or the LCD panel display turns off during recharging, replace the batteries with new ones.
- Use a new set of four batteries of the same brand. When replacing the batteries, replace all four at one time.
- AA/HR6 Ni-MH batteries can also be used.

Attaching and Detaching the Control Unit to and from the Camera

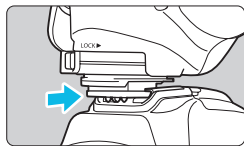

1 Attach the control unit.

- Slip the control unit's mounting foot **all the way** into the camera's hot shoe.

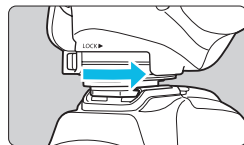

2 Secure the control unit.

- Slide the mounting foot lock lever to the right.
- ▶ When the lock lever clicks in place, it is locked.

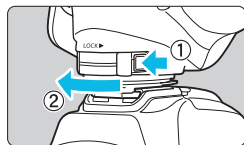

3 Detach the control unit.

- While pressing the lock-release button, slide the lock lever to the left and detach the control unit from the camera.

 Be sure to turn off the MT-26EX-RT before attaching or detaching it.

Attaching and Detaching the Flash Unit to the Lens

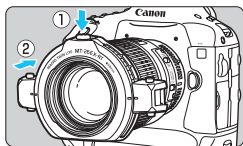

1 Attach the flash unit to the front of the lens while holding down the release button on the mount ring.

- Position the release button toward the top.
- Make sure that the flash unit is securely attached.
- Detach the flash unit while holding down the release button.

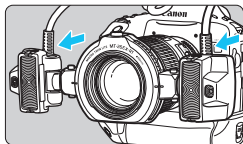

2 Attach flash heads A and B to flash head mounts.

- Push them in to the mounting feet until they click in place.
- To detach the flash heads, press the release lever (p.10).



- Be sure to attach the flash unit to the lens when shooting. Shooting while holding the flash unit in your hand may result in a low temperature burn.
- Do not touch the flash unit or batteries immediately after continuous flash firing or modeling flash (p.34). Touching them may result in a burn. Make sure that the flash unit has cooled before detaching the flash unit or replacing batteries.
- To rotate the mount ring, be sure to first hold down the release button.
- If the Macrolite Adapter 72C screwed onto the EF180mm f/3.5L Macro USM lens filter thread becomes stuck and cannot be unscrewed, without pressing the release button, turn the mount ring against the lens in the direction you would to detach the adapter.
- The flash unit cannot be attached to the EF-M28mm f/3.5 Macro IS STM.



When using the following lenses, attach the Macrolite Adapter (sold separately) to the front of the lens (filter mounting thread) and then attach the flash unit.

- EF100mm f/2.8L Macro IS USM: Macrolite Adapter 67
- EF180mm f/3.5L Macro USM: Macrolite Adapter 72C

Adjusting the Flash Unit

Flash Unit Adjustment Range

The MT-26EX-RT's flash unit can be adjusted within the range shown below to match the lens and subject.

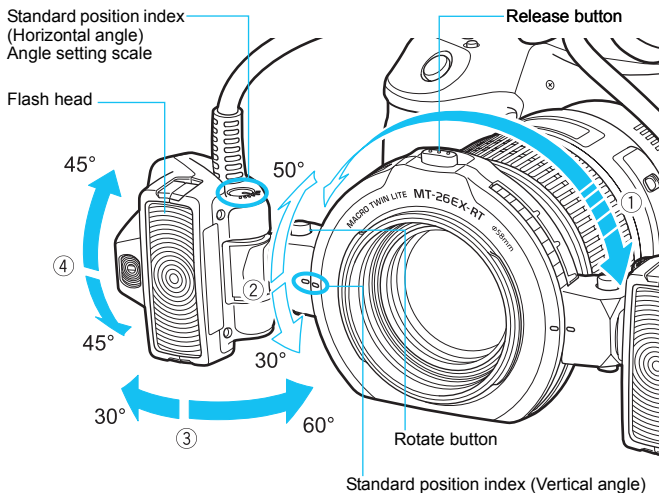

- ① To rotate the mount ring, rotate it while holding down the release button.
- ② To rotate the flash head mount, rotate it while holding down the rotate button.
- ③ To rotate the flash head in the direction of ④, directly move the flash head.

- Do not adjust the flash head angle beyond the adjustable range. Doing so may cause the flash head to detach and fall from the flash head mount.
- The adjustable range may be further limited depending on the camera and lens.

Adjustment Guidelines

This is a general guide to setting the flash angle for various magnifications with a macro lens. Refer to the angle scale (15° increments) on the side of the flash head and set the same angle for both flash heads A and B. The angle specifications in the table below indicate the inner angle relative to the flash head's standard position index (horizontal).

Lens	Magnification	Flash Head Inner Angle				
		60°	45°	30°	15°	0°
EF50mm f/2.5 Compact Macro	1:2		●	●		
	1:2.5 - 1:3			●		
	1:4			●	●	
	1:5 - 1:6				●	
	1:8				●	●
	1:10					●
EF50mm f/2.5 Compact Macro +Life-Size Converter EF	1:1		●			
	1:1.2		●	●		
	1:1.5 - 1:2			●		
	1:4				●	
EF100mm f/2.8L Macro IS USM EF100mm f/2.8 Macro USM	1:1 - 1:1.5		●	●		
	1:2			●	●	
	1:2.5 - 1:3				●	
	1:4					●
EF100mm f/2.8 Macro	1:1		●			
	1:1.5			●		
	1:2			●	●	
	1:2.5 - 1:3				●	
	1:4					●

Lens	Magnification	Flash Head Inner Angle				
		60°	45°	30°	15°	0°
EF180mm f/3.5L Macro USM	1:1			●	●	
	1:1.2 - 1:1.5				●	
	1:2 - 1:10					●
EF-S35mm f/2.8 Macro IS STM	1:1*	●				
	1:1.4	●				
	1:2	●				
	1:3.3		●	●		
EF-S60mm f/2.8 Macro USM	1:1		●	●		
	1:1.5			●		
	1:2			●	●	
	1:3				●	
	1:4					●
	1:5					●
MP-E65mm f/2.8 1-5x Macro Photo	5x - 2x	●				
	1x		●			

* Near the closest focusing distance, the flash unit may touch the subject depending on the shape or size of the subject. Also, the light from the focusing lamp may be obstructed.

Using a Filter

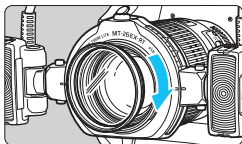

A commercially-available filter can be used during flash photography. A filter can be attached, using the two procedures described below. Filters may not be used together with some macro lenses.

- (1) Attach a 58 mm filter to the filter mounting thread of the mount ring (see the above illustration).
- (2) Attach the flash unit to the lens with the filter attached to the front of the lens (filter mounting thread).

Macro Lens	Filter Compatibility	
	(1)	(2)
EF50mm f/2.5 Compact Macro	Not usable* ¹	Usable
EF100mm f/2.8 Macro	Usable	
EF100mm f/2.8 Macro USM		Not Usable
EF100mm f/2.8L Macro IS USM		Conditionally usable* ²
EF180mm f/3.5L Macro USM		Conditionally usable* ³
EF-S35mm f/2.8 Macro IS STM		
EF-S60mm f/2.8 Macro USM		Usable
MP-E65mm f/2.8 1-5x Macro Photo		Not Usable

*1: The lens cannot be used with a filter, since focusing is interrupted by an attached filter touching the front of the lens. Also, filter may be damaged or the lens malfunction may result.

*2: Attach a filter to the front of the lens before attaching Macrolite Adapter (p.21) to the front part of the filter. If attachment threads are not provided on the front rim of the filter, the flash unit cannot be attached since Macrolite Adapter cannot be attached. Note that if the flash unit is attached after a filter and Macrolite Adapter are attached to the front of the lens, the periphery of the photo may look darker.

*3: Attach the Lens Hood ES-27 to the front of the lens before attaching a 49 mm filter.

Using a Hood

- When mounting a dedicated hood (sold separately) to the MP-E65mm f/2.8 1-5x Macro Photo or mounting the Lens Hood ES-27 to EF-S35mm f/2.8 Macro IS STM, first attach the hood, then attach the mount ring. If a hood is attached, a 58 mm filter cannot be attached to the filter mounting thread of the mount ring.
- With the EF100mm f/2.8 Macro USM, the Lens Hood ET-67 can be attached to the mount ring's hood mount. Use ambient light for shooting. Using flash will result in darkened edges.

Turning on the Power

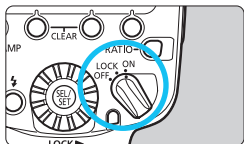

1 Set the power switch to <ON>.

- ▶ The flash recharge starts.
- ▶ During recharging, < **CHARGE** > is displayed on the LCD panel. When flash recharge is complete, this indicator disappears.

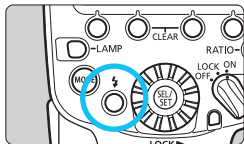

2 Check that the flash is ready.

- The status of the flash-ready lamp changes from **off** to **green** (Quick flash ready), then to **red** (fully charged).
- You can press the test flash button (flash-ready lamp) to fire a test flash.

Quick Flash Function

The Quick flash function enables flash photography when the flash-ready lamp is lit green (before the flash is fully charged). Quick flash is available regardless of the camera's drive mode setting. Although the flash output will be approx. 1/2 to 1/6 of the full output, it is useful for shooting with a shorter firing interval.

During manual flash shooting, this function is available when the flash output is set to 1/4 or smaller. Note that you cannot use Quick flash with FEB or during wireless multiple flash shooting.



- When Quick flash is fired during continuous shooting, underexposure may occur since the flash output decreases.
- Note that the test flash cannot be performed while the camera's metering timer, etc. is operating.



For the display of < **CHARGE** > during radio transmission wireless multiple flash shooting, see page 72.

Auto Power Off Function

To save battery power, the power will turn off automatically after approx. 90 sec. of idle use. To turn on the MT-26EX-RT again, press the camera's shutter button halfway or press the test flash button (flash-ready lamp).

When set as the master unit for radio transmission wireless multiple flash shooting (p.58), the time until auto power off takes effect is approx. 5 min.

Lock Function

By setting the power switch to <LOCK>, you can disable the flash's button and dial operations. It is useful when you want to prevent the flash function settings from being accidentally changed after you set them.

If you operate a button or dial, <LOCKED> is displayed on the LCD panel. While the lock is active, the functions displayed above function buttons 1 to 4, such as <Z/C.Fn> and <Z/>, are not displayed.

LCD Panel Illumination

When a button or dial is operated, the LCD panel illuminates for approx. 12 sec. (☺12).

During normal flash photography and radio/optical transmission wireless multiple flash shooting (p.58/82), the LCD panel illuminates in green.

For the LCD panel illumination during radio transmission wireless multiple flash shooting, see page 72.



- The flash settings will remain in effect even after the power is turned off. To retain the settings when replacing the batteries, replace the batteries after turning off the power switch.
- You can fire a test flash or turn on/off the focusing lamp while the power switch is set to the <LOCK> position. Also, when a button or dial is operated, the LCD panel illuminates.
- You can disable Quick flash (P.Fn-05, p.105).
- Auto power off can be disabled (C.Fn-01, p.101).
- You can select the charging method to be used when an external power source is used (C.Fn-12, p.102).
- You can change the setting of the LCD panel illumination (C.Fn-22, p.103).
- You can change the color of the LCD panel illumination (P.Fn-04, p.104).

ETTL: Fully Automatic Flash Photography

When you set the camera's shooting mode to <P> (Program AE) or fully automatic mode, you can shoot in E-TTL II/E-TTL fully automatic flash mode.

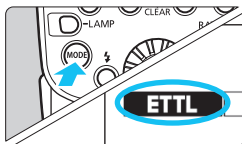

1 Set the flash mode to <ETTL>.

- Press the <MODE> button.
- Turn <⊙>, select <ETTL>, then press <⊙>.
- Check that <MASTER> is not displayed.

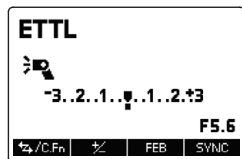

2 Focus on the subject.

- Press the shutter button halfway to focus.
- ▶ The shutter speed and aperture are displayed in the viewfinder.
- Check that <⚡> is lit in the viewfinder.

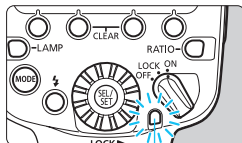

Flash exposure confirmation lamp

3 Take the picture.

- When you press the shutter button completely, the flash will fire and the picture will be taken.
- ▶ If the standard flash exposure is obtained, the flash exposure confirmation lamp lights for approx. 3 sec.



- If the flash exposure confirmation lamp does not light or if the subject is dark (underexposed) when you check the shot image, move closer to the subject and shoot again. You can also increase the ISO speed when using a digital camera.
- “Fully automatic” refers to <A+>, <□>, and <CA> shooting modes.
- Even when attached to a camera that supports the E-TTL II autoflash system, <ETTL> is displayed on the LCD panel.

E-TTL II/E-TTL Autoflash by Shooting Mode

Simply by setting the camera's shooting mode to <Av> (aperture-priority AE) or <M> (manual exposure), you can execute macro flash photography using E-TTL II/E-TTL autoflash.

Av	<p>You can perform flash photography while obtaining a standard exposure of both the main subject and background while considering the depth of field.</p> <p>Select this mode when you want to set the aperture manually. The camera will then automatically set the shutter speed, matching the aperture to obtain the standard exposure based on the metering of the camera. For low-light scenes, a slow sync speed will be used to obtain the standard exposure for both the main subject and background. The standard exposure for the main subject is obtained with the flash light, while the standard exposure for the background is obtained with a long exposure using a slow shutter speed.</p> <ul style="list-style-type: none">● Since a slow shutter speed will be used for low-light scenes, using a tripod is recommended.● If the shutter speed blinks, it means that the background exposure will be underexposed or overexposed. Adjust the aperture until the shutter speed stops blinking.
M	<p>Select this mode if you want to set the shutter speed and aperture manually.</p> <p>Standard exposure of the main subject is obtained with the flash light. The exposure of the background changes according to the shutter speed and aperture combination you set.</p>

- When the shutter speed is manually set with the shooting mode set to <Tv> (Shutter-priority AE), the aperture will be set automatically. However, this is not recommended because the aperture cannot be set manually.
- If you use the <DEP> or <A-DEP> shooting mode, the result will be the same as using the <P> (Program AE) mode.

Flash Sync Speeds and Apertures by Shooting Mode

	Shutter Speed	Aperture
P	Automatically set (1/X sec. to 1/60 sec.)	Automatically set
Av	Automatically set (1/X sec. to 30 sec.)	Manually set
M	Manually set (1/X sec. to 30 sec., Bulb)	Manually set

- 1/X sec. is the camera's maximum flash sync speed.

Focusing Lamp

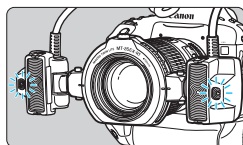
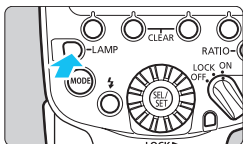

Press the <LAMP> button to light the focusing lamp for 20 sec., making focusing easier. Press the button again to turn off the lamp.

The focusing lamp turns off automatically when you press the shutter button on the camera completely.



- Note that looking closely at the focusing lamp may cause vision damage.
- If you shoot when the focusing lamp is lit, underexposure may occur. If necessary, set the exposure compensation or flash exposure compensation.
- Under conditions where the flash is not fired, such as in Flash Off mode or during movie shooting, the focusing lamp will not turn off automatically even if you press the shutter button completely.



- You can change the lighting method of the focusing lamp (C.Fn-18, p.103).
- You can change the brightness of the focusing lamp (P.Fn-01, p.104).
- You can select the lighting duration of the focusing lamp (P.Fn-02, p.104).

Modeling Flash

When the camera's depth-of-field preview button is pressed, the flash fires continuously for approx. 1 sec. This feature is called "modeling flash". This is effective for checking shadows cast on the subject and the lighting balance. Modeling flash can be fired during radio transmission wireless multiple flash shooting (p.58) or optical transmission wireless multiple flash shooting (p.82) as well.

-  ● To avoid degrading and damaging the flash head due to overheating, do not fire the modeling flash more than 20 times continuously. After firing it 20 times continuously, allow a rest time for at least 10 min.
- During Live View shooting, firing modeling flash (by operating the camera) is not possible.
- Modeling flash (by operating the camera) is disabled when using the flash unit with EOS M6, EOS M5, EOS M3, EOS M2, EOS M, EOS Elan II/Elan II E/50/50E, EOS REBEL 2000/300, EOS REBEL G/500N, EOS REBEL K2/3000V, EOS REBEL XS N/REBEL G II/3000N/66, EOS IX, or EOS IX Lite/IX7. Set C.Fn-02 to 1 or 2 (p.101), and then fire modeling flash using the test flash button. (When using the EOS M series cameras listed above, the test flash button functions when the camera's metering timer is not active.)

 You can use the test flash button to fire the modeling flash (C.Fn-02, p.101).

Color Temperature Information Transmission

This function adjusts the white balance depending on the color temperature of the flash light by transmitting the color temperature information to the EOS DIGITAL camera when the flash fires. When you set the camera's white balance to <AWB>, <AWB w>, or <☀>, the function is enabled automatically.

Refer to the specifications in your camera's Instruction Manual to find out if it is compatible with this function.

Effective Flash Metering Range



The MT-26EX-RT's effective flash metering range largely varies depending on the flash heads' position.



Combined Use with the Diffuser Adapter

If you shoot with the provided diffuser adapter attached to the flash heads, you can spread the flash light across a large area and suppress the shadows on the subject.

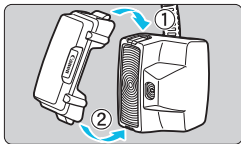

Attach the diffuser adapter.

- Attach the diffuser adapter securely to a flash head until it clicks in place, as shown.

The diffuser adapter can be attached to either flash head A or B.

Attached to A Attached to B Attached to A,B



- ▶ The display indicating that the diffuser adapter is being used is shown.

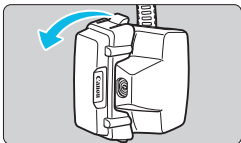

- When removing the diffuser adapter, follow the procedure in reverse order. Raise the removal tab on the side of the adapter, then remove the adapter from the flash head.



- When the diffuser adapter is attached, the effective flash metering range changes. Take necessary countermeasures such as adjusting the ISO speed on the camera or applying flash exposure compensation (p.40) as necessary.
- When Quick flash (p.27) is fired with the diffuser adapter attached, taking the picture after the flash-ready lamp is lit in red is recommended since the flash output may not be sufficient.
- If you attach the diffuser adapter to MT-26EX-RT when using an EOS DIGITAL camera released up to 2004, set the white balance to <AWB>. If you shoot with <⚡>, appropriate white balance may not be obtained.



If the subject is dark (underexposed) when you check the shot image, perform flash exposure compensation (p.40). You can also increase the ISO speed when using a digital camera.

A:B Setting the Flash Ratio ☆

You can adjust the flash ratio between flash heads A and B, or fire only one of them. This can create shadows on the subject to give a more sculptural look. The flash ratio can be set in half-stop increments as follows: 8:1 to 1:1 to 1:8 (13 settings).



A:B = 1:1



A:B = 4:1



Fire A only



Fire B only

Flash with the A:B Flash Ratio Set

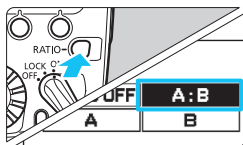

1 Set to < A:B >.

- Press the <RATIO> button.
- Turn <⊙>, select < A:B >, then press <⊙>.

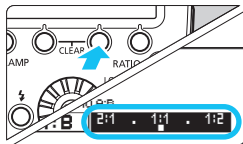

2 Press the < Gr > button.

- Press function button 3 < Gr >.
- ▶ The flash ratio is highlighted.

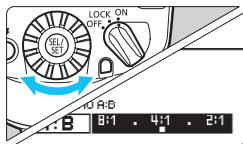

3 Set the flash ratio.

- Turn <⊙> to set the A:B flash ratio, then press <⊙>.

Single-side Firing

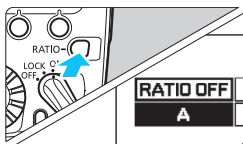

Set to < **A** > or < **B** >.

- Press the < **RATIO** > button.
- Turn < >, select < **A** > or < **B** >, then press < >.

Fire A only

Fire B only

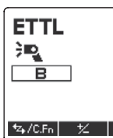
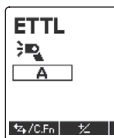

Flash ratio control is not available on the models listed below. Both sides will fire at the same flash output, or single-side firing will apply.

EOS Elan II/Elan II E/50/50E, EOS REBEL XS N/REBEL G II/3000N/66, EOS REBEL 2000/300, EOS REBEL G/500N, EOS IX, EOS IX Lite/IX 7



- The flash ratio of 8:1 to 1:1 to 1:8 is equivalent to 3:1 to 1:1 to 1:3 (1/2-stop increments) when converted to the number of stops.
- The details of the flash ratio settings are as follows.

8:1 • 4:1 • 2:1 • 1:1 • 1:2 • 1:4 • 1:8
1/2 stop 1/2 stop 1/2 stop 1/2 stop 1/2 stop 1/2 stop 1/2 stop
 5.6:1 • 2.8:1 • 1.4:1 • 1:1.4 • 1:2.8 • 1:5.6



- When < **A:B** >, < **A** >, or < **B** > is not displayed, flash heads A and B will fire at the same flash output.
- When the flash mode is set to < **M** >, see pages 45 - 47.

Flash Exposure Compensation[☆]

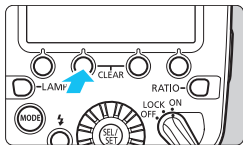
With a similar procedure as exposure compensation, you can adjust the flash output. The flash exposure compensation amount can be set up to ± 3 stops in 1/3-stop increments.





1 Press the button.

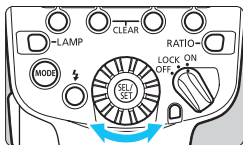

- Press function button 2 .
- You can also set the amount by pressing .
- ▶  is displayed and the flash exposure compensation amount is highlighted.



2 Set the flash exposure compensation amount.

- Turn  to set the flash exposure compensation amount, then press .
- ▶ The flash exposure compensation amount is set.
- “0.3” indicates 1/3 stop and “0.7” indicates 2/3 stops.
- To cancel flash exposure compensation, return the compensation amount to ± 0 .



- Generally, set an increased exposure compensation for bright subjects and set a decreased exposure compensation for dark subjects.
- If the camera's exposure compensation is set in 1/2-stop increments, flash exposure compensation will be up to ± 3 stops in 1/2-stop increments.
- When the flash exposure compensation is set on both the flash and the camera, priority is given to the flash setting.
- The flash exposure compensation amount can be set directly with  without pressing the function button 2  (C.Fn-13, p.102).

You can take three shots while automatically changing the flash output. This is called FEB (Flash Exposure Bracketing). The settable range is up to ± 3 stops in 1/3-stop increments.

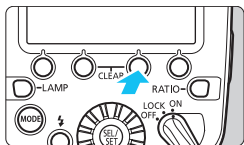

1 Press the < FEB > button.

- Press function button 3 < FEB >.
- ▶ < > is displayed and the FEB level display is highlighted.

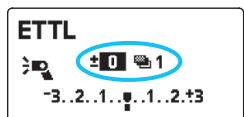

2 Set the FEB level.

- Turn < > to set the FEB level, then press < >.
- ▶ The FEB level is set.
- “0.3” indicates 1/3 stop and “0.7” indicates 2/3 stops.
- When used together with flash exposure compensation, FEB shooting is performed based on the set flash exposure compensation amount. When the FEB range exceeds ± 3 stops, the end of the flash exposure level shows < < > or < > >.

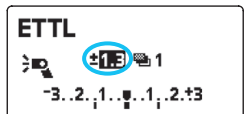
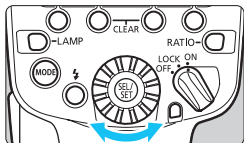

- After the three shots are taken, FEB is canceled automatically.
- Before shooting with FEB, it is recommended to set the camera's drive mode to single shooting and check that the flash has been recharged. When the drive mode is set to continuous shooting, shooting automatically stops after three continuous shots are taken.
- You can use FEB together with flash exposure compensation or FE lock.
- If the camera's exposure compensation is set in 1/2-stop increments, flash exposure compensation will be up to ± 3 stops in 1/2-stop increments.
- You can set FEB to remain enabled after shooting the three shots (C.Fn-03, p.101).
- You can change the FEB shooting sequence (C.Fn-04, p.102).

FEL: FE Lock ☆

The FE (Flash Exposure) lock locks the correct flash exposure setting for any part of the subject.

With <ETTL> displayed on the LCD panel, press the camera's <M-Fn> button. For cameras without a <M-Fn> button, press the <✱> (AE lock) or <FEL> button.

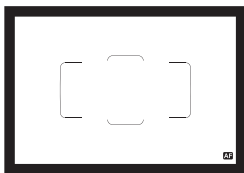

1 Focus on the subject.

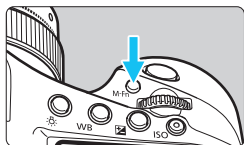

2 Press the <M-Fn> button (ⓘ16).

- With the subject at the center of the viewfinder, press the camera's <M-Fn> button.
- ▶ The MT-26EX-RT will fire a preflash, and the required flash output for the subject is retained in memory.
- ▶ “FEL” will be displayed in the viewfinder for approx. 0.5 sec.
- Each time you press the <M-Fn> button, a preflash will be fired and the new flash output required at that time is retained in memory.



- If a correct exposure cannot be obtained when FE lock is performed, <⚡> blinks in the viewfinder. Move closer to the subject or open the aperture, and perform FE lock again. You can also set a higher ISO speed and perform FE lock again when using a digital camera.
- If the target subject is too small in the viewfinder, FE lock may not be effective.
- When you press the <✱> button of an EOS M series camera, a circle indicating the flash metering range will be displayed at the center of the screen. (<⚡✱> will also be displayed depending on the camera model.)

High-speed Sync[☆]

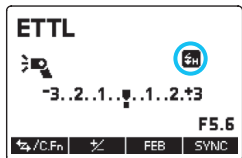
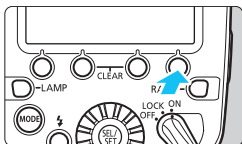

With high-speed sync, you can shoot with a flash at all shutter speeds. This is effective when you want to shoot in the aperture-priority AE <Av> mode with background blur (by opening the aperture) in locations such as outdoors in daylight.



Display <>.

- Press function button 4 < **SYNC** > to display <>.
- Check that <> is lit in the viewfinder, then shoot.

 With high-speed sync, the faster the shutter speed, the lower the guide number becomes.

- When the shutter speed is less than or equal to the maximum flash sync shutter speed, <> is not displayed in the viewfinder.
- To return flash firing to normal, press function button 4 < **SYNC** > to turn off <>.

▶▶▶ Second-curtain Sync ☆

Shooting with a slow shutter speed and second-curtain sync captures the trail of the light sources of a moving subject in a natural way. The flash fires right before the exposure finishes (shutter closes).

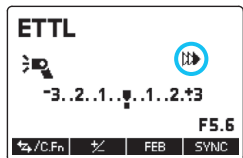
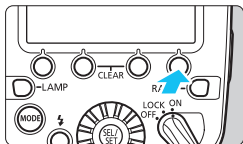

Display <▶▶▶>.

- Press function button 4 < **SYNC** > to display <▶▶▶>.

- The second-curtain sync works well when the camera's shooting mode is set to <bulb(B)> (bulb shooting).
- When the flash mode is set to <E TTL>, the flash fires twice. The first flash is a preflash to determine the flash output. It is not a malfunction.
- Second-curtain sync is disabled during wireless multiple flash shooting.
- To return flash firing to normal, press function button 4 < **SYNC** > to turn off <▶▶▶>.

M: Manual Flash ☆

You can set the flash output in the range of 1/1 full output to 1/512 power in 1/3-step increments. You can take pictures using three methods: firing with both flash heads A and B at the same flash output, firing with both flash heads A and B at different flash outputs, and single-side (A or B only) firing.

Setting the camera's shooting mode to <Av> or <M> is recommended. Additionally, take a test shot first to check the exposure.

Firing with Both Flash Heads A and B at the Same Flash Output

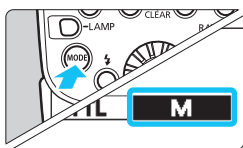

1 Set the flash mode to <M>.

- Press the <MODE> button.
- Turn <⊙>, select <M>, then press <⊙>.

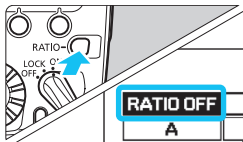

2 Turn off the <RATIO> display.

- Press the <RATIO> button.
- Turn <⊙>, select <RATIO OFF>, then press <⊙>.

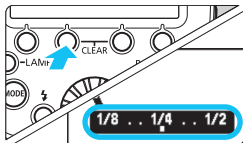

3 Set the flash output.

- Press function button 2 <⌘> or <⊙>.
- ▶ The flash output level is highlighted.
- Turn <⊙> to set the flash output, then press <⊙>.



- If high-speed sync is set, the setting range will be 1/1 - 1/64.
- The guide number will differ between both-sides firing and single-side firing even when the flash output settings are the same (p.120).



Without pressing function button 2 <⌘> or <⊙>, you can directly turn <⊙> and set the flash output (C.Fn-13, p.102).

Firing Flash Heads A and B at a Different Flash Output

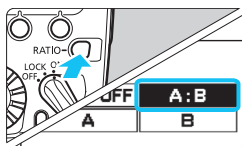

1 Set < A > and < B >.

- Press the <RATIO> button.
- Turn < ⓪ >, select < A:B >, then press < ● >.

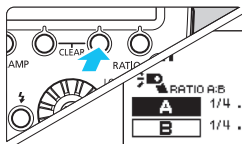

2 Select a flash head.

- Press function button 3 < Gr > or < ⓪ > and turn < ⓪ > to select flash head A or B.

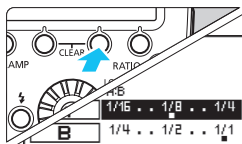

3 Set the flash output.

- Press function button 3 < *% > or < ⓪ >.
- Turn < ⓪ > to set the flash output, then press < ● >.
- Repeat steps 2 and 3 to set the flash output for flash heads A and B.

Single-side Firing

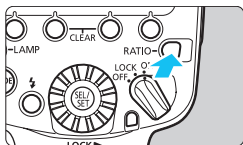

1 Set < **A** > or < **B** >.



- Press the < **RATIO** > button.
- Turn < A > or < **B** >, then press < 

Fire A only

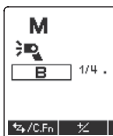
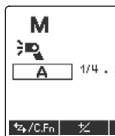
Fire B only



2 Set the flash output.

- Press function button 3 < - Turn < 

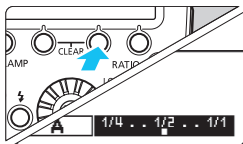

Metered Manual Flash Exposure

When using an EOS-1D series camera, the flash exposure level can be manually set before shooting. This is effective when you are close to the subject. Use an 18% gray reflector (commercially available) and shoot as follows.

1 Configure the camera and MT-26EX-RT settings.

- Set the camera's shooting mode to <M> or <Av>.
- Set the MT-26EX-RT flash mode to <M>.

2 Focus on the subject.

- Focus manually.

3 Set up an 18% gray reflector.

- Place the gray reflector at the subject's position.
- Aim the camera so that the entire spot metering circle within the viewfinder center is over the gray reflector.

4 Press the <M-Fn>, <✳>, or <FEL> button (Ⓜ16).

- ▶ The MT-26EX-RT will fire a preflash and the required flash output for the correct flash exposure is retained in memory.
- ▶ On the right side of the viewfinder, the exposure level indicator will show the flash exposure level against the standard exposure.

5 Set the flash exposure level.

- Adjust the MT-26EX-RT's manual flash output and the aperture so that the flash exposure level aligns with the standard exposure index.

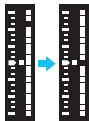

6 Take the picture.

- Remove the gray reflector and take the picture.

 Metered manual flash exposure is available only with EOS-1D series cameras.

Clearing MT-26EX-RT Settings ☆

You can revert the settings of the MT-26EX-RT shooting functions and wireless multiple flash shooting settings to their defaults.

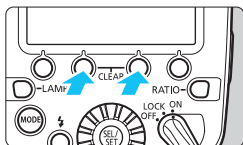

Clear the settings.

- Press function buttons 2 and 3 for seconds until **<CLEARED>** is displayed.
- ▶ The MT-26EX-RT settings are cleared, and normal flash photography with **<ETTL>** flash mode will be set.

 Even when the settings have been cleared, the transmission channel and wireless radio ID for wireless multiple flash shooting as well as the settings of the Custom Functions (C.Fn) and Personal Functions (P.Fn) will not be cleared.



2

Setting Flash Functions with Camera Controls

This chapter describes how to set the flash functions from the camera's menu screen.

 When the camera's shooting mode is set to a fully automatic mode or a Basic Zone mode, the operations in this chapter are not available. Set the camera's shooting mode to **<P/Tv/Av/M/bulb(B)>** (Creative Zone mode).

Flash Control from the Camera's Menu Screen

When using EOS DIGITAL cameras released in and after 2007, you can set flash functions or Custom Functions from the camera's menu screen.

For camera operations, refer to the camera's Instruction Manual.

Flash Function Settings

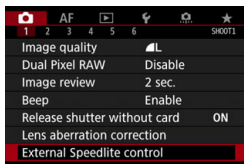

1 Select [External Speedlite control].

- Select [External Speedlite control] or [Flash control].

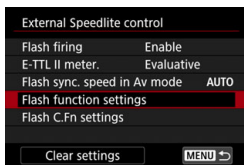

2 Select [Flash function settings].

- Select [Flash function settings] or [External flash func. setting].
- ▶ The setting screen is displayed.

3 Set the function.

- The setting screen and items displayed vary depending on the camera.
- To set the wireless functions, select [1:Slave A, B and C] for C.Fn-15 in [Flash C.Fn settings] or [External flash C.Fn setting].
- Select an item and set the function.

Example 1

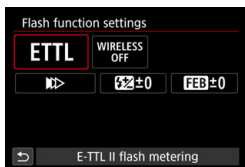

Example 2

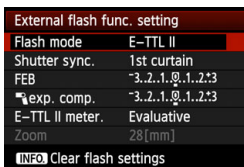

Settings Available on the Flash Function Settings Screen

● EOS DIGITAL cameras released in and after 2014

On the camera's flash function setting screen, you can configure the settings for normal flash photography, flash ratio control, radio transmission wireless multiple flash shooting, and optical transmission wireless multiple flash shooting. To set radio transmission wireless multiple flash shooting or optical transmission wireless multiple flash shooting, set C.Fn-15-1 beforehand.

* Although EOS REBEL T6/1300D and EOS REBEL T5/1200D were released in and after 2014, the settable functions are the same as with EOS DIGITAL cameras released from 2007 up to 2011.

● EOS DIGITAL cameras released from 2012 up to 2013

EOS-1D X, EOS 6D, EOS 5D Mark III, EOS 70D, EOS REBEL SL1/100D, EOS REBEL T5i/700D, EOS REBEL T4i/650D, EOS M2, EOS M

On the camera's flash function setting screen, you can configure the settings for normal flash photography, radio transmission wireless multiple flash shooting, and optical transmission wireless multiple flash shooting. To set optical transmission wireless multiple flash shooting, set C.Fn-15-1 beforehand. To use flash ratio control, set the function by operating the flash.

● EOS DIGITAL cameras released from 2007 up to 2011

EOS-1Ds Mark III, EOS-1D Mark IV/III, EOS 5D Mark II, EOS 7D, EOS 60D, EOS 50D, EOS 40D, EOS REBEL T3i/600D, EOS REBEL T2i/550D, EOS REBEL T1i/500D, EOS REBEL XSi/450D, EOS REBEL T3/1100D, EOS REBEL XS/1000D

On the camera's flash function setting screen, you can configure the settings for normal flash photography and optical transmission wireless multiple flash shooting. To use flash ratio control or radio transmission wireless multiple flash shooting, set the functions by operating the flash.

The major settable functions are as follows. The settings available vary by the camera used, flash mode, and wireless function settings, etc. If they cannot be set from the camera's screen, set them by operating the flash.

Functions	
Flash firing	Enable / Disable
E-TTL II flash metering	Evaluative / Average
Flash synchronization speed in Av mode	
Flash mode	E-TTL II (autoflash) / Manual flash
Firing ratio control	
Shutter synchronization	First-curtain synchronization / Second-curtain synchronization / High-speed synchronization
Flash exposure compensation	
Flash exposure bracketing	
Wireless functions	Wireless: Off / Radio transmission / Optical transmission
Clear settings	

- **Flash firing**

To perform flash photography, set to **[Enable]**.

- **E-TTL II flash metering**

For normal exposures, set it to **[Evaluative]**. If **[Average]** is set, the flash exposure will be averaged for the entire scene metered by the camera. Flash exposure compensation may be necessary depending on the scene. This setting is for advanced users.

- **Flash synchronization speed in Av mode**

You can set the flash synchronization speed when shooting in aperture-priority AE <**Av**> mode with flash.

- **Flash mode**

You can select **[E-TTL II]** or **[Manual flash]** according to your photographic objectives.

- **Firing ratio control**

You can adjust the flash ratio of flash heads A and B or fire only single side.

- **Shutter synchronization**

You can select the flash firing timing/method from [**First-curtain synchronization**], [**Second-curtain synchronization**], or [**High-speed synchronization**]. To perform normal flash photography, set [**First-curtain synchronization**].

- **Flash exposure compensation**

With a similar procedure as exposure compensation, you can adjust the flash output. The flash exposure compensation amount can be set up to ± 3 stops in 1/3-stop increments.

- **Flash exposure bracketing**

You can take three shots while automatically changing the flash output. The settable range is up to ± 3 stops in 1/3-stop increments.

- **Wireless functions**

You can set radio transmission wireless multiple flash shooting and optical transmission wireless multiple flash shooting. For details, see Chapter 3 (p.57) and Chapter 4 (p.81).

- **Clear settings**

When [**Clear flash settings**] or [**Clear external flash set.**] is selected, you can revert the settings of MT-26EX-RT to their default settings.



When the flash exposure compensation is set on the flash, flash exposure compensation cannot be performed from the camera. If both are set at the same time, priority is given to the setting on the flash.



- [**Flash firing**] and [**E-TTL II flash metering**] are displayed in step 2 or step 3 on page 52. (Display layouts and procedures vary by camera model.)
- When [**Flash sync. speed in Av mode**] is not displayed, it can be set with the camera's Custom Functions.

Flash Custom Function Settings

You can set Custom Functions for the MT-26EX-RT from the camera's menu screen. The details displayed vary by the camera used. If C.Fn-22 is not displayed, set them by operating the MT-26EX-RT. For the Custom Functions, see pages 98-103.

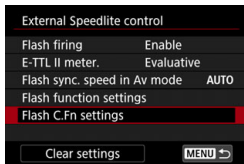

1 Select [Flash C.Fn settings].

- Select [Flash C.Fn settings] or [External flash C.Fn setting].
- ▶ The flash Custom Function settings screen is displayed.

Custom Function number

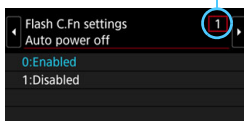

2 Set the Custom Function.

- Select the Custom Function number.
- Select an item and set the function.

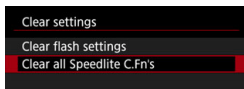

- To clear all the Custom Function settings, select [Clear settings] in step 1, then [Clear all Speedlite C.Fn's] or [Clear ext. flash C.Fn set.].

- When using a camera released in 2011 or earlier, or with EOS REBEL T6/1300D or EOS REBEL T5/1200D, the C.Fn-22 setting is not cleared even if [Clear all Speedlite C.Fn's] or [Clear ext. flash C.Fn set.] is selected. When the procedure to clear all the Custom Functions described on page 100 is performed, all the Custom Functions are cleared.
- Personal Functions (P.Fn, p.104) cannot be set or all cleared at once from the camera's menu screen. Set them by operating the MT-26EX-RT.

3

Radio Transmission Wireless Multiple Flash Photography

This chapter describes multiple flash photography using the radio transmission wireless master function.

For the accessories required for radio transmission wireless multiple flash photography, see the system map (p.108).

For the regions of use, restrictions, and precautions related to radio transmission, see page 122.

- When the camera's shooting mode is set to a fully automatic mode or a Basic Zone mode, the operations in this chapter are not available. Set the camera's shooting mode to **<P/Tv/Av/M/bulb(B)>** (Creative Zone mode).
- With the MT-26EX-RT, linked shooting by radio transmission cannot be performed.

- The MT-26EX-RT attached to the camera is called "master", and the Speedlite controlled wirelessly is called "slave".
- MT-26EX-RT allows remote release (remote control photography) from the slave unit (p.67). For details, refer to the Instruction Manual of the Speedlite that is equipped with the remote release function.

(☞) Radio Transmission Wireless Multiple Flash Photography

Using a Canon Speedlite equipped with the radio transmission wireless shooting function, you can easily perform wireless multiple flash photography in the same way as normal E-TTL II/E-TTL autoflash photography.

The system is designed so that the settings of MT-26EX-RT (master) are automatically applied to the wirelessly controlled Speedlite (slave). Therefore, you do not need to operate the slave unit during shooting.

Positioning and Operation Range (Wireless multiple flash shooting examples)

● Multiple Flash Photography with Slave C Added (p.69)

You can perform multiple flash shooting, using flash heads A and B of the master unit and a slave unit set to firing group C (slave C). Slave C is automatically controlled to obtain a standard exposure by firing group C alone. Therefore, it can be used to eliminate shadows on the subject or create an accent light.

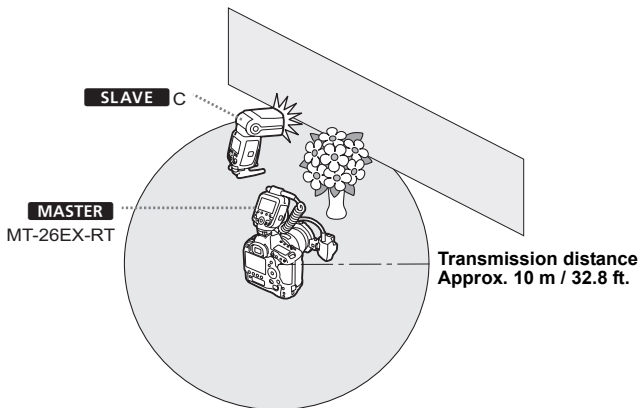

● **Advanced Multiple Flash Photography with Slaves A, B, and C Added** (p.74)

You can perform multiple flash shooting not only with slave C, but also with slaves A and B added. Slave A is controlled to fire with flash head A and slave B to fire with flash head B as a group (as a single flash unit).

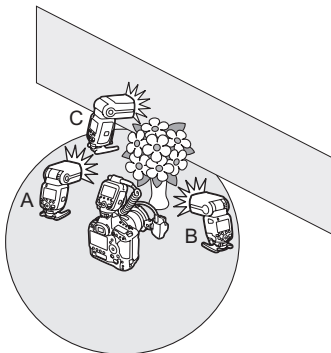

- Shooting with firing group C pointed directly toward the main subject may result in overexposure.
- Before shooting, perform a test flash (p.27) and test shooting.
- The transmission distance may be shorter depending on the conditions such as the positioning of slave flashes, the surrounding environment, and weather conditions.

☞ Using the mini stand provided with the slave unit, position the slave unit.

● Advanced Multiple Flash Photography in a Different Flash Mode for Each Group (p.78)

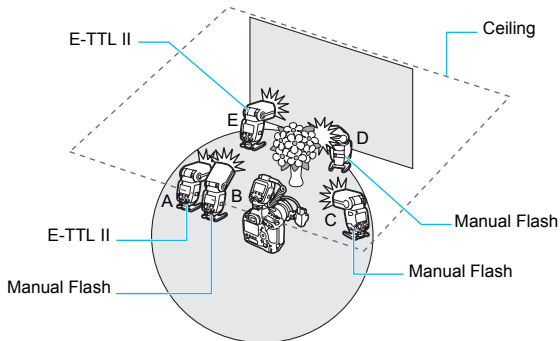

* The flash mode settings are indicated only as an example.

Difference between Radio Transmission and Optical Transmission

Wireless multiple flash shooting using radio transmission has advantages over wireless multiple flash shooting using optical transmission, such as being less affected by obstacles and not having to point the slave unit's wireless sensor toward the master unit. The main functional differences are as follows.

Function	Radio Transmission	Optical Transmission
Transmission distance	Approx. 10 m / 32.8 ft.	Approx. 0.2 - 10 m / 0.7 - 32.8 ft. (indoors)
Firing group control	Up to 5 groups* (A, B, C, D, E)	Up to 3 groups (A, B, C)
Slave unit control	Up to 15 units	No restriction
Channel	Auto, Ch. 1 - 15	Ch. 1 - 4
Wireless radio ID	0000 - 9999	-

* Some restrictions apply depending on the camera used. See p.62, 78.

Group Control

Slave A is controlled to fire with flash head A and slave B to fire with flash head B as a group (as a single flash unit). Multiple units can be used as slave C, D, and E. You can increase the number of slave units up to 15 units.

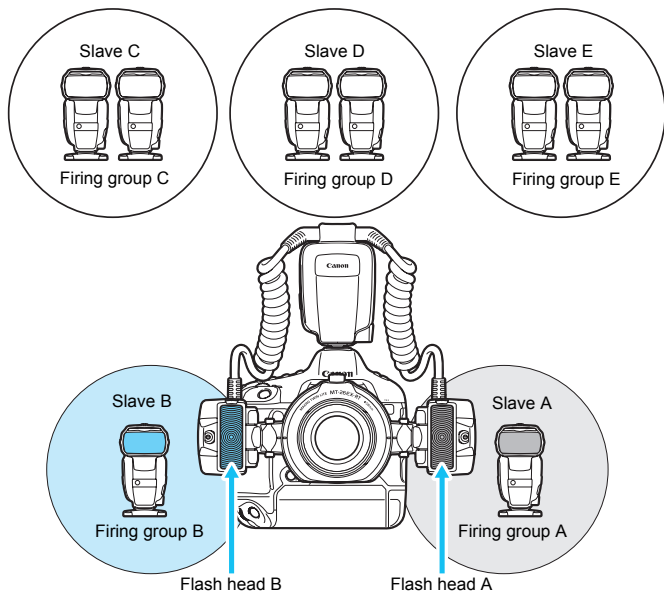

Restrictions on Functions Depending on the Camera Used

When performing radio transmission wireless multiple flash photography, function restrictions may apply, depending on the camera used.

● EOS DIGITAL cameras released in and after 2012

When using the flash with EOS DIGITAL cameras released in and after 2012, you can shoot without any restrictions on the flash mode and flash synchronization speed, etc.

* Although EOS REBEL T6/1300D and EOS REBEL T5/1200D were released after 2012, restrictions on functions are the same as with EOS DIGITAL cameras released up to 2011. (See the following explanation for details.)

● EOS cameras compatible with E-TTL and released up to 2011

When using the flash with the cameras listed below, radio transmission wireless shooting using E-TTL autoflash is not possible. Shoot with manual flash (p.76) or optical transmission wireless multiple flash (p.81).

EOS-1Ds, EOS-1D, EOS-1V, EOS-3, EOS Elan II/Elan II E/50/50E, EOS REBEL 2000/300, EOS REBEL G/500N, EOS REBEL XS N/REBEL G II/3000N/66, EOS IX, EOS IX Lite/IX7

Also, when using the flash with an EOS DIGITAL camera or EOS film camera released up to 2011, the following restrictions apply.

1. **The maximum flash sync shutter speed becomes 1 stop slower.**

Check the maximum flash sync shutter speed ($X = 1/^{***}$ sec.) of your camera and shoot with a shutter speed up to 1 stop slower than the maximum flash sync shutter speed (Example: When $X = 1/250$ sec., radio transmission wireless multiple flash shooting is possible from $1/125$ sec. to 30 sec.).

When you set the shutter speed 1 stop slower than the maximum flash sync shutter speed, the <TV> warning icon will disappear.

-
- 2. High-speed sync shooting is not possible.**
- 3. Group flash (p.78) is not possible.**

Radio Transmission Wireless Settings

To perform radio transmission wireless multiple flash shooting with E-TTL II/E-TTL autoflash, set the master unit and slave unit with the following procedure.

Master Unit Setting

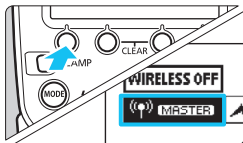

Display <((P))> and < **MASTER** >.

- Press function button 1 < **Z/C.Fn** >.
- Turn < **DISP** >, select <((P)) **MASTER** >, then press < **DISP** >.

- Press the < **RATIO** > button, then select the firing method from the options below (p.74).
 - < **RATIO OFF** > and < **ALL** >
 - < **RATIO A:B** > and < **A:B** >
 - < **RATIO A:B C** > and < **A:B** > < **C** >

Slave Unit Setting

Set the slave firing group (A, B, C) while referring to the Instruction Manual of the Speedlite equipped with the radio transmission wireless slave function.

When establishing multiple radio transmission wireless flash systems in a place, interference between flash systems may occur even if the flashes are set to different channels. Set different wireless radio IDs for each channel (p.65).

To perform normal flash photography, select < **WIRELESS OFF** > to clear the master settings.

Setting the Transmission Channel/Wireless Radio ID

Use the following procedure to set the transmission channels and wireless radio IDs of the master unit. **Set the same channel and ID for both the master unit and slave unit.** For details on the slave operation procedure, refer to the Instruction Manual of the Speedlite equipped with the radio transmission wireless slave function.

1 Display <MENU 3>.

- Press function button 4 to display <MENU 3>.

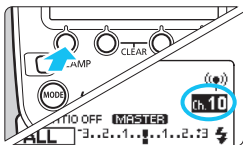

2 Set a transmission channel.

- Press function button 1 <CH>.
- Turn <⊙> to select "AUTO" or any channel between Ch.1 to 15, then press <⊙>.

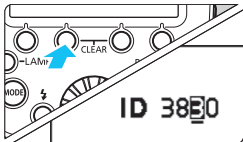

3 Set a wireless radio ID.

- Press function button 2 <ID>.
- Turn <⊙> to select the position (digit) to be set, then press <⊙>.
- Turn <⊙> to select a number from 0 to 9, then press <⊙>.
- Set a 4-digit number with the same procedure.
- Once the settings are complete, press function button 4 <↵>.
- ▶ You can check the transmission status of the master unit and slave unit by viewing the icons on the LCD panel (p.67).

● Scanning and Setting the Transmission Channels

You can scan the radio reception status and set the transmission channel automatically or manually. When the channel is set to “AUTO”, the channel with the best reception signal is reset automatically. When setting the channel manually, you can reset the transmission channel while referring to the scan results.

● Scanning when “AUTO” is set

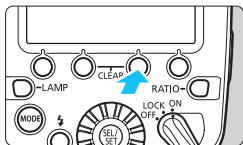

Run the scan.

- Press function button 4 to display **< MENU 3 >**.
- Press function button 3 **< SCAN >**.
- ▶ The scan is performed, and the channel with the best reception signal is reset.

● Scanning when a channel between Ch. 1 and 15 is set

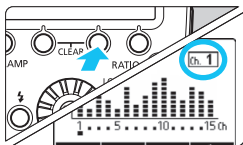

1 Run the scan.

- Press function button 4 to display **< MENU 3 >**.
- Press function button 3 **< SCAN >**.
- ▶ The scan is performed and the reception status is displayed in a graph.
- The higher the peak of the channel in the graph, the better the radio reception signal.

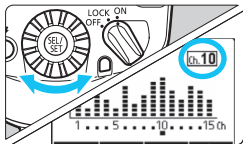

2 Set a channel.

- Turn **< ⓪ >** to select a channel from Ch. 1 to 15.
- Press **< ⓪ >** to set the channel.

Connection Indicator

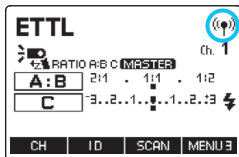

You can check the transmission status by viewing the icons on the LCD panel.

Display	Description	Action
	Transmission OK	-
	Not connected	Check the channel and ID.
	Too many units	Change the master and slave unit total to 16 or less.
	Error	Turn the master unit and slave unit off and on again.



- If the transmission channels of the master unit and slave unit are different, the slave unit will not fire. Set them both to “AUTO” or set them to the same number.
- If the wireless radio IDs of the master unit and slave unit are different, the slave unit does not fire. Set to the same number.



For the remote release from a slave unit, **<RELEASE>** is displayed on the LCD panel.

Memory Function

You can save the wireless settings and recall the settings later.

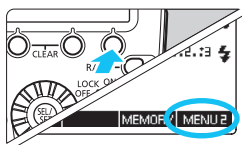

1 Display <MEMORY>.

- Press function button 4 to display <MENU 2>.



2 Save or load the settings.

- Press function button 3 <MEMORY>.

[Save]

- Press function button 1 <SAVE>.
- ▶ The settings are saved (stored in the memory).

[Load]

- Press function button 2 <LOAD>.
- ▶ The settings that were saved are set.

ETTL: Multiple Flash Photography with Slave C Added

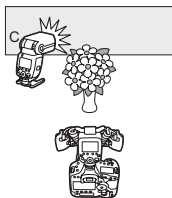

This section describes multiple flash shooting with slave C added to flash heads A and B.

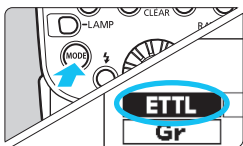

1 Set the flash mode to <ETTL>.

- Press the <MODE> button.
- Turn <⊙>, select <ETTL>, then press <⊙>.

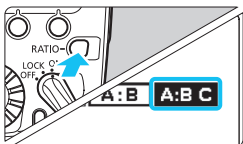

2 Set <A:B> and <C>.

- Press the <RATIO> button.
- Turn <⊙>, select <A:B C>, then press <⊙>.

3 Check the transmission channel and wireless radio ID.

- If the channels of the master unit and slave unit are different, set them both to “AUTO” or set them to the same number (p.65).
- If the wireless radio ID of the master unit and slave unit are different, set them to the same number (p.65).

4 Set slave C and position it.

- Set the firing group of the slave unit to C, and position the unit within the range shown on page 58.

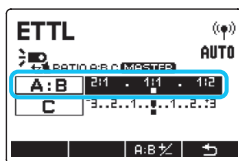

5 Set the A:B flash ratio.

- Press function button 3 < Gr >, turn < ⏪ >, select < A:B >, then press < ⏩ >.
- Turn < ⏪ > to set the A:B flash ratio, then press < ⏩ >.

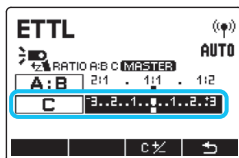

6 Set the flash exposure compensation amount for slave C.

- Turn < ⏪ >, select < C >, then press < ⏩ >.
- Turn < ⏪ > to set the flash exposure compensation amount, then press < ⏩ >.

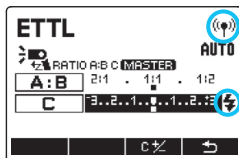

7 Check the transmission status and charge status.

- Check that < (⚡) > is not displayed on the master unit's LCD panel.
- Check that the < ⚡ > icon is lit on the master unit's LCD panel (< CHARGE > is not displayed).
- For the master unit's LCD panel illumination, see page 72.
- Check that the master unit's flash-ready lamp is lit.

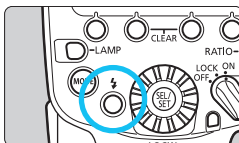

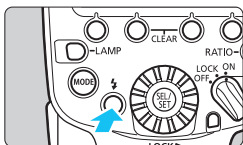

8 Check the performance.

- Press the master unit's test flash button.
- ▶ The flash fires. If it does not fire, check that it is placed within the transmission range (p.58).

9 Take the picture.

- Set the camera and take the picture in the same way as with normal flash photography.
- ▶ If the standard flash exposure is obtained, the flash exposure confirmation lamp lights for approx. 3 sec.



- When <ⓂⓂ> is displayed on the LCD panel, radio transmission cannot be performed. Check the transmission channels and wireless radio IDs of the master unit and slave unit again. If you cannot connect with the same settings, turn the master unit and slave unit off and on again.
- Shooting with firing group C pointed directly toward the main subject may result in overexposure.



- You can press the depth-of-field preview button on the camera to fire the modeling flash (p.34).
- When a MT-26EX-RT is set as the master unit, the time until auto power off takes effect is approx. 5 min.
- If the slave unit's auto power off takes effect, press the master unit's test flash button to turn on the slave unit. Note that the test flash cannot be performed while the camera's metering timer, etc. is operating.

LCD Panel Illumination

During radio transmission wireless multiple flash shooting, the master unit's LCD panel illuminates or turns off according to the charge status of the master unit and slave units (firing groups).

The master unit's LCD panel illuminates if the master unit and slave units are not fully charged. When the master unit and slave units are fully charged, the LCD panel illumination will turn off after approx. 12 sec.

When the charging of the master unit and slave unit starts as you take pictures, the master unit's LCD panel will be illuminated again.

 If the master unit or any of the slave units (firing group) are not fully charged, < **CHARGE** > will be displayed on the master unit's LCD panel. Check that < **CHARGE** > is not displayed on the LCD panel, and take a picture.

Multiple Flash Photography with Wireless Functions

Since the following functions set on the master unit will be set automatically to the slave units with this wireless system, you do not need to operate the slave unit(s). For this reason, you can perform radio transmission wireless multiple flash photography in the same way as normal flash photography.

- **Flash exposure compensation** (🔧/p.40)
- **FEB** (🔧/p.41)
- **FE lock** (p.42)
- **High-speed sync** (🔧/p.43)
- **Manual flash** (p.45, 76)

Master Units

You can designate two or more master units. By preparing multiple cameras with master units attached, you can change cameras while keeping the same lighting (slave units) during wireless multiple flash photography.

Note that when using two or more master units, the display on the LCD panel will change depending on the order in which the master setting was performed. The first master (main master) is displayed as < **MASTER** >, and the second and subsequent masters (sub-masters) are displayed as < **SUB.MASTER** >.



- If < (🔧) > is displayed on the LCD panel, the connection has not been established. After checking the transmission channel and wireless radio ID, turn each master unit off and on again.
- During radio transmission wireless multiple flash shooting, limit the total number of masters and slaves up to 16 units.



- < **SYNC** > and < **FEB** > are displayed when function button 4 < **MENU *** > is pressed.
- You can take pictures even when the master flash is set as a sub-master.

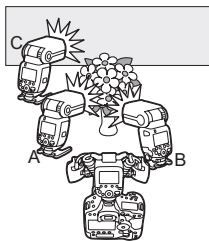

ETTL: Advanced Multiple Flash Photography with Slaves A, B, and C Added

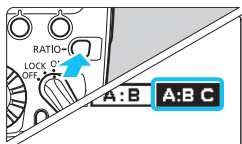

Multiple flash shooting can be performed not only with slave C but also with slave A and B. For an outline of controlling flash, see “Group Control” on page 61. Multiple flash shooting can be performed with flash heads A and B as well as the slave unit(s) firing at the same output, or with only slave A or B added, regardless of the slave’s firing group settings.



1 Set < **A:B** > and < **C** >.

- Press the < **RATIO** > button.
- Turn <  >, select < **A:B C** >, then press <  >.

2 Set and position slave A, B, and C.

- Check that the same transmission channel and wireless radio ID are set for all slave units and the master unit.
- Set slave units as A, B, or C respectively and place them in position.

3 Take the picture.

- Set the flash ratio for the firing group (flash head + slave) A:B and the flash exposure compensation amount for slave C, following the procedure described in “Multiple Flash Photography with Slave C Added” (p.69), then take the picture.



- To fire flash heads A and B and the slave unit at the same flash output, set < **ALL** > in step 1. You can set any of A, B, or C as the firing group for the slave units.
- To add slave A and B only, set < **A:B** > in step 1.

M: Multiple Flash Photography with Manual Flash Output

This section describes wireless multiple flash shooting using manual flash. You can shoot with flash output set within a range of 1/1 full output to 1/128 power in 1/3-step increments for each firing group. Set all the parameters on the master unit.

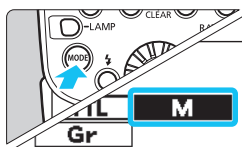

1 Set the flash mode to <M>.

- Press the <MODE> button.
- Turn <⊙>, select <M>, then press <⊙>.

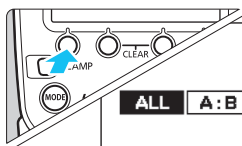

2 Set the firing group.

- Press the <RATIO> button.

- Turn <⊙> to select the firing method from the options below. You can perform wireless multiple flash shooting with slave A, B, and C added.
 - All slave units have the same flash output: <ALL>
 - Set flash output for slave units A and B: <A B>
 - Set flash output for slave units A, B, and C: <A B C>

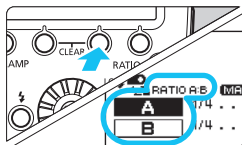

3 Select a firing group.

- When <A B> or <A B C> is selected in step 2, press function button 3 <Gr> or <⊙>, turn <⊙>, then select the group for the flash output setting.

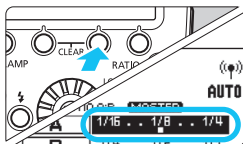

4 Set the flash output.

- Press function button 3 **< *½ >** or **< ● >**.
- Turn **< ● >** to set the flash output, then press **< ● >**.
- Repeat steps 3 and 4 to set the flash output of all groups.

5 Take the picture.

- ▶ Each group fires at the set flash output.



If high-speed sync is set, the setting range will be 1/1 - 1/64.



- When **< ALL >** is set, set A, B, or C as the firing group for the slave units. The flash will not fire if it is set to D or E.
- To fire multiple slave units with the same flash output, select **< ALL >** in step 2.

Gr: Shooting in a Different Flash Mode for Each Group

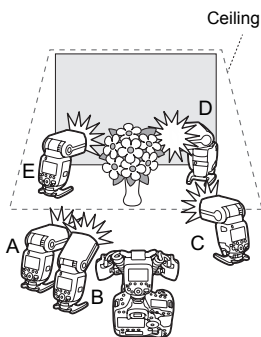

When using an EOS DIGITAL camera released in and after 2012, you can shoot in a different flash mode set for each firing group with up to 5 groups (A, B, C, D, and E).

The flash modes that can be set are ① E-TTL II/E-TTL autoflash, ② Manual flash, and ③ Auto external flash metering. When the flash mode is ① or ③, exposure is controlled to result in standard exposure for the main subject as a single group.

This function is for advanced users who are very knowledgeable and experienced in lighting.

⚠ Wireless multiple flash shooting using the <Gr> flash mode cannot be performed with cameras released up to 2011 or with EOS REBEL T6/1300D or EOS REBEL T5/1200D. Shooting with up to 3 groups (A, B, and C) will be applied (p.74).

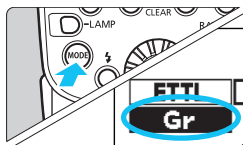

1 Set the flash mode to <Gr>.

- Press the <MODE> button on the master unit.
- Turn <⊙> to select <Gr>, then press <⊙>.
- The slave unit's flash mode is set automatically during shooting, controlled by the master unit.

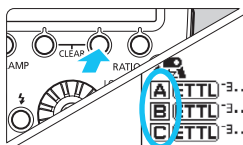

2 Set the firing group of the slave units.

- Set the firing group (A, B, C, D, or E) for all the slave units.

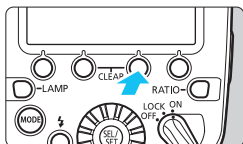

3 Set each firing group.

- Set the flash mode of each firing group by operating the master unit.
- With **<MENU 1>** displayed, press function button 3 **<Gr>** (12).
- Turn **<⊙>** to select the group to set the firing group.

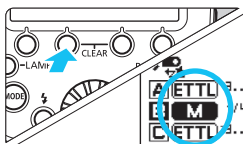

Setting the flash mode

- Press function button 2 **<*MODE>**, then select the firing mode from **<ETTL>**, **<M>**, or **<Ext.A>**.

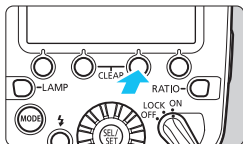

Setting the flash output and flash exposure compensation amount

- Press function button 3 **<*1/2>**.
- Turn **<⊙>** to set the flash output or flash exposure compensation amount, then press **<⊙>**.
- When using the **<M>** mode, set the flash output. When using the **<ETTL>** or **<Ext.A>** mode, set the flash exposure compensation amount as required.
- Repeat step 3 to set the flash function of all firing groups.
- If you press function button 2 **<*1/2>** when **<MENU 1>** is displayed, flash exposure compensation can be set for all the firing groups.

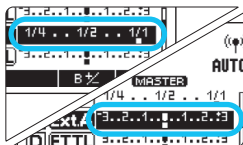

Firing group charge status

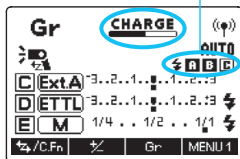

4 Check the charge status and then shoot.

- When **< CHARGE >** is displayed, you can check the firing groups that are not fully charged by the indication on the screen on the left. For example, when firing group **< A >** is fully charged, the **< A >** indication in the screen on the left changes to **< A >**.
- When all firing groups are fully charged, **< CHARGE >** and the charge status indication for the firing groups on the screen on the left disappear.
- For other charge confirmations, see step 7 on page 70.
- ▶ Each slave unit fires simultaneously in the respective flash mode set.

- When **< A >** or **< B >** is set to **< Ext.A >**, **< A >** or **< B >** of the MT-26EX-RT will not fire.
- When setting the flash mode to **< Ext.A >**, make sure the slave units are the Speedlites supporting the Auto external flash metering. Firing in this flash mode is not possible if Auto external flash metering is not supported.
- When the flash mode is set to **< E TTL >** or **< Ext.A >**, exposure is controlled as a single group to obtain the standard exposure for the main subject. If you shoot with multiple firing groups pointing toward the main subject, overexposure may result.

- For **< Ext.A >** see the Instruction Manual of the Speedlite that supports Auto external flash metering.
- The order of firing among firing groups does not need to be consecutive; for example, A, C, E can be set.
- When you do not want a certain group to fire, press function button 1 **< ON/OFF >** to set **< OFF >** when setting the flash mode in step 3.

4

Optical Transmission Wireless Multiple Flash Photography

This chapter describes multiple flash photography using the optical transmission wireless master function. For the accessories required for optical transmission wireless multiple flash photography, see the system map (p.108).

 When the camera's shooting mode is set to a fully automatic mode or a Basic Zone mode, the operations in this chapter are not available. Set the camera's shooting mode to **<P/Tv/Av/M/bulb(B)>** (Creative Zone mode).

 The MT-26EX-RT attached to the camera is called “master”, and the Speedlite controlled wirelessly is called “slave”.

Optical Transmission Wireless Multiple Flash Photography

Using a Canon Speedlite (slave) equipped with the optical transmission wireless shooting function, you can easily perform wireless multiple flash photography in the same way as normal E-TTL II/E-TTL autoflash photography.

The system is designed so that the settings of MT-26EX-RT (master) are automatically applied to the wirelessly controlled Speedlite (slave). Therefore, you do not need to operate the slave unit during shooting.

Positioning and Operation Range (Wireless multiple flash shooting examples)

Multiple Flash Photography with Slave C Added (p.88)

You can perform multiple flash shooting, using flash heads A and B of the master unit and a slave unit set to firing group C (slave C). Slave C is automatically controlled to obtain a standard exposure by firing group C alone. Therefore, it can be used to eliminate shadows on the subject or create an accent light.

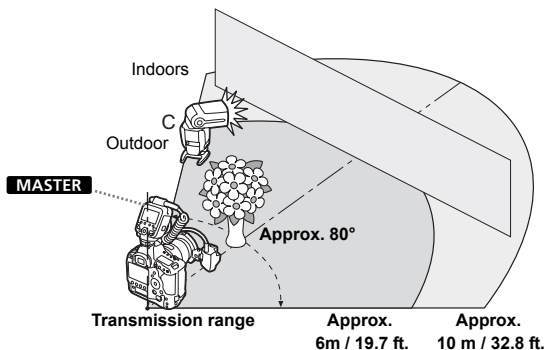

● **Advanced Multiple Flash Photography with Slaves A, B, and C Added** (p.92)

You can perform multiple flash shooting not only with slave C, but also with slaves A and B added. Slave A is controlled to fire with flash head A and slave B to fire with flash head B as a group (as a single flash unit).

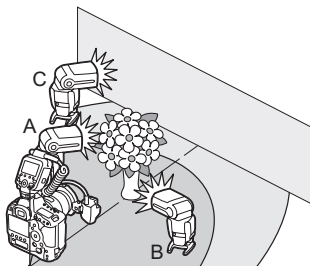

- Shooting with firing group C pointed directly toward the main subject may result in overexposure.
- Before shooting, perform a test flash (p.27) and test shooting.
- To avoid interfering with transmission, do not place any obstacles between the master unit and slave unit.

- Using the mini stand provided with the slave unit, position the slave unit with its sensor facing the master unit.
- When shooting indoors, since the transmission signal is reflected off the walls, operation may be possible even with slightly imprecise positioning.

Group Control

Slave A is controlled to fire with flash head A and slave B to fire with flash head B as a group (as a single flash unit). Multiple units can also be set as slave C. Note that there is no limit for the number of units that can be used as slave A, B, or C.

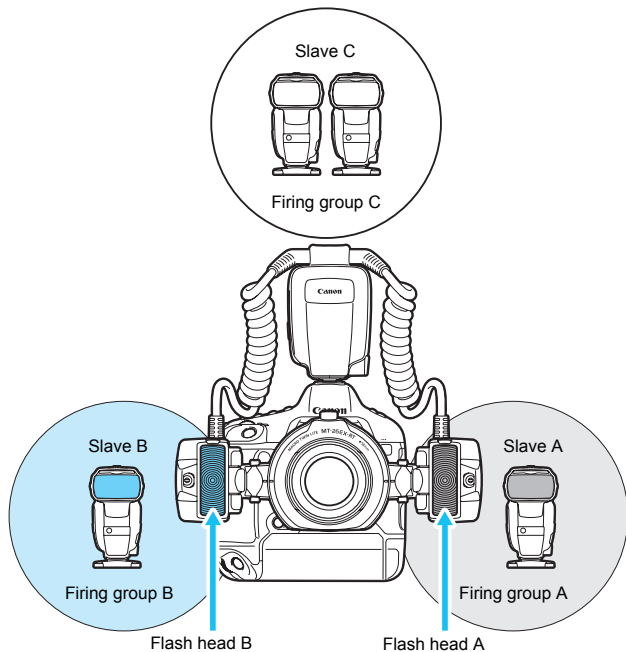

Optical Transmission Wireless Settings

To perform optical transmission wireless multiple flash shooting with E-TTL II/E-TTL autoflash, set the master unit and slave unit with the following procedure.

Master Unit Setting

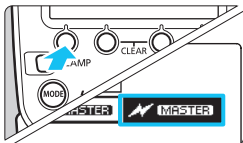

Display < ⚡ > and < **MASTER** >.

- Press function button 1 < C.Fn >.
- Turn < ⌚ >, select < ⚡ **MASTER** >, then press < ⌚ >.
- Press the < **RATIO** > button, then select the firing method from the options below (p.92).
 - < **RATIO OFF** > and < **ALL** >
 - < **RATIO A:B** > and < **A:B** >
 - < **RATIO A:B C** > and < **A:B** > < **C** >

Slave Unit Setting

Set the slave firing group (A, B, C) while referring to the Instruction Manual of the Speedlite equipped with the optical transmission wireless slave function.

 To perform normal flash photography, select < **WIRELESS OFF** > to clear the master settings.

Transmission Channel Setting

With the following procedure, set the transmission channels of the master unit. **Set the same channel for both the master unit and slave unit.** For details on the slave operation procedure, refer to the Instruction Manual of the Speedlite equipped with the optical transmission wireless slave function.

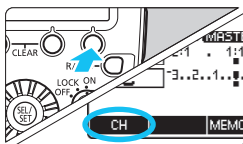

1 Display < MENU 2 >.

- Press function button 4 to display < MENU 2 >.

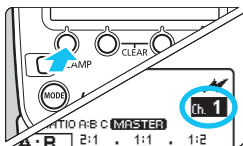

2 Set a transmission channel.

- Press function button 2 < CH >.
- Turn < Ⓞ > to select any channel between Ch.1 to 4, then press < Ⓞ >.

! If the transmission channels of the master unit and slave unit are different, the slave unit will not fire. Set both to the same number.

Memory Function

You can save the wireless settings and recall the settings later.

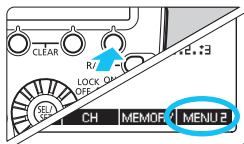

1 Display <MEMORY>.

- Press function button 4 to display <MEMORY>.

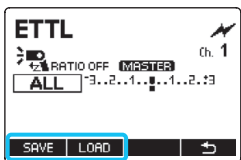

2 Save or load the settings.

- Press function button 3 <MEMORY>.

[Save]

- Press function button 1 <SAVE>.
- ▶ The settings are saved (stored in the memory).

[Load]

- Press function button 2 <LOAD>.
- ▶ The settings that were saved are set.

ETTL: Multiple Flash Photography with Slave C Added

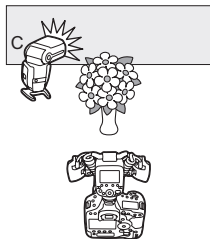

This section describes multiple flash shooting with slave C added to flash heads A and B.

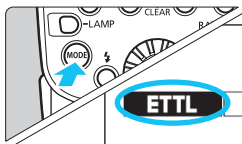

1 Set the flash mode to <ETTL>.

- Press the <MODE> button.
- Turn <⊙>, select <ETTL>, then press <⊙>.

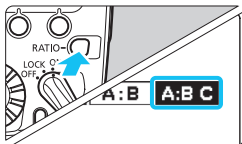

2 Set <A:B> and <C>.

- Press the <RATIO> button.
- Turn <⊙>, select <A:B C>, then press <⊙>.

3 Check the transmission channel.

- If the channels of the master unit and slave unit are different, set them to the same number (p.86).

4 Set slave C and position it.

- Set the firing group of the slave unit to C, and position the unit within the range shown on page 82.

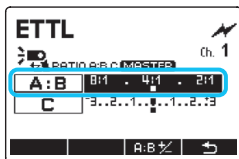

5 Set the A:B flash ratio.

- Press function button 3 < Gr >, turn < ⓪ >, select < A:B >, then press < ⓪ >.
- Turn < ⓪ > to set the A:B flash ratio, then press < ⓪ >.

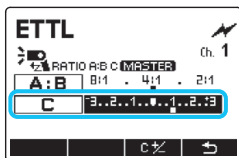

6 Set the flash exposure compensation amount for slave C.

- Turn < ⓪ >, select < C >, then press < ⓪ >.
- Turn < ⓪ > to set the flash exposure compensation amount, then press < ⓪ >.

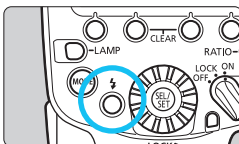

7 Check that the flash is ready.

- Check that the master unit's flash-ready lamp is lit.
- Check that the slave unit is fully charged.

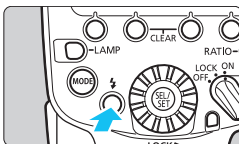

8 Check the performance.

- Press the master unit's test flash button.
 - ▶ The slave unit C fires. If it does not fire, check that it is placed within the operation range.

9 Take the picture.

- Set the camera and take the picture in the same way as with normal flash photography.
 - ▶ If the standard flash exposure is obtained, the flash exposure confirmation lamp lights for approx. 3 sec.

- Shooting with firing group C pointed directly toward the main subject may result in overexposure.

- On the models listed below, wireless multiple flash shooting adding slave C is not available when the <ETTL> mode is set. When the <M> mode is set, wireless multiple flash shooting can be performed on all type-A cameras (p.2).

EOS Elan II/Elan II E/50/50E, EOS REBEL XS N/REBEL G II/3000N/66, EOS REBEL 2000/300, EOS REBEL G/500N, EOS IX, EOS IX Lite/IX 7

- If there is a fluorescent light or computer monitor near a slave unit, the presence of the light source may cause the slave unit to malfunction and fire inadvertently.

- You can press the depth-of-field preview button on the camera to fire the modeling flash (p.34).
- If the slave unit's auto power off takes effect, press the master unit's test flash button to turn on the slave unit. Note that the test flash cannot be performed while the camera's metering timer, etc. is operating.

Multiple Flash Photography with Wireless Functions

Since the following functions set on the master unit will be set automatically to the slave units with this wireless system, you do not need to operate the slave unit(s). For this reason, you can perform optical transmission wireless multiple flash photography in the same way as normal flash photography.

- **Flash exposure compensation** (☒/p.40)
- **FEB** (☒/p.41)
- **FE lock** (p.42)
- **High-speed sync** (☒/p.43)
- **Manual flash** (p.45, 94)

ETTL: Advanced Multiple Flash Photography with Slaves A, B, and C Added

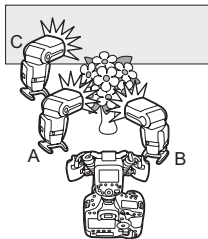

Multiple flash shooting can be performed not only with slave C but also with slave A and B. For an outline of controlling flash, see “Group Control” on page 84. Multiple flash shooting can be performed with flash heads A and B as well as the slave unit(s) firing at the same output, or with only slave A or B added, regardless of the slave’s firing group settings.

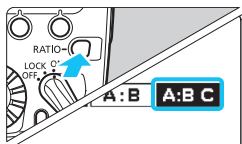

1 Set < **A:B** > and < **C** >.

- Press the < **RATIO** > button.
- Turn < **⊙** >, select < **A:B C** >, then press < **⊙** >.

2 Set and position slave A, B, and C.

- Check that the same transmission channel is set for all slave units and the master unit.
- Set slave units as A, B, or C respectively and place them in position.

3 Take the picture.

- Set the flash ratio for the firing group (flash head + slave) A:B and the flash exposure compensation amount for slave C, following the procedure described in “Multiple Flash Photography with Slave C Added” (p.88), then take the picture.



- To fire flash heads A and B and the slave unit at the same flash output, set < **ALL** > in step 1. You can set any of A, B, or C as the firing group for the slave units.
- To add slave A and B only, set < **A:B** > in step 1.

M: Wireless Multiple Flash Photography with Manual Flash Output

This section describes wireless multiple flash shooting using manual flash. You can shoot with flash output set within a range of 1/1 full output to 1/128 power in 1/3-step increments for each firing group. Set all the parameters on the master unit.

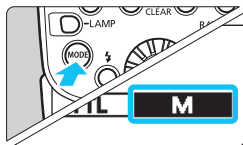

1 Set the flash mode to <M>.

- Press the <MODE> button.
- Turn <⊙>, select <M>, then press <⊙>.

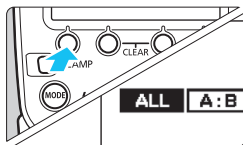

2 Set the firing group.

- Press the <RATIO> button.

- Turn <⊙> to select the firing method from the options below. You can perform wireless multiple flash shooting with slave A, B, and C added.
 - All slave units have the same flash output: <ALL>
 - Set flash output for slave units A and B: <A B>
 - Set flash output for slave units A, B, and C: <A B C>

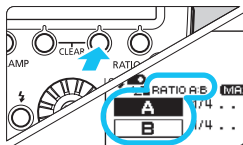

3 Select a firing group.

- When <A B> or <A B C> is selected in step 2, press function button 3 <Gr> or <⊙>, turn <⊙>, then select the group for the flash output setting.

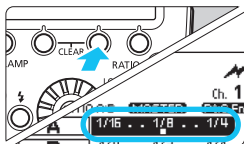

4 Set the flash output.

- Press function button 3 < *½ > or < Ⓞ >.
- Turn < Ⓞ > to set the flash output, then press < Ⓞ >.
- Repeat steps 3 and 4 to set the flash output of all groups.

5 Take the picture.

- ▶ Each group fires at the set flash output.



If high-speed sync is set, the setting range will be 1/1 - 1/64.



When < ALL > is set, you can set any of A, B, or C as the firing group for the slave units. Each group will fire according to the set flash output.

5

Customizing the MT-26EX-RT

This chapter describes how to customize the MT-26EX-RT with the Custom Functions (C.Fn) and Personal Functions (P.Fn).

 When the camera's shooting mode is set to a fully automatic mode or a Basic Zone mode, the operations in this chapter are not available. Set the camera's shooting mode to <P/Tv/Av/M/bulb(B)> (Creative Zone mode).

C.Fn / P.Fn: Setting Custom and Personal Functions

You can make precise adjustments to various flash functions to suit your picture-taking preferences. The functions used to do this are called the Custom Functions and Personal Functions. The Personal Functions are customizable functions unique to the MT-26EX-RT.

C.Fn: Custom Functions

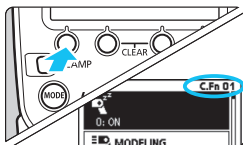

1 Display the Custom Functions screen.

- Press and hold function button 1 < **Z-/C.Fn** > until the screen is displayed.
- ▶ The Custom Functions screen is displayed.

2 Select an item to set.

- Turn < **SEL** > to select an item (number) to be set.

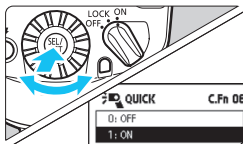

3 Change the setting.

- Press < **SEL** >.
- ▶ The setting is displayed.
- Turn < **SEL** > to select your desired setting, then press < **SEL** >.

P.Fn: Personal Functions

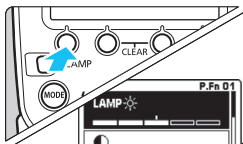







1 Display the Personal Functions screen.

- After performing step 1 in the Custom Functions procedure, press function button 1 < **P.Fn** >.
- ▶ The Personal Functions screen is displayed.





2 Set the function.

- Set the Personal Functions in the same way as steps 2 and 3 for the Custom Functions.

Custom Function List

Number	Item		Page
C.Fn-01		Auto power off	p.101
C.Fn-02	 MODELING	Modeling flash	
C.Fn-03	 AUTO CANCEL	FEB auto cancel	
C.Fn-04		FEB sequence	p.102
C.Fn-12		Flash recycle with external power	
C.Fn-13		Flash exposure compensation setting	
C.Fn-18	LAMP	Macro: Focusing lamp on/off	p.103
C.Fn-22		LCD panel illumination	

Personal Function List

Number	Item		Page
P.Fn-01	LAMP 	Macro: Focusing lamp brightness	p.104
P.Fn-02	LAMP 	Macro: Focusing lamp on time	
P.Fn-03		LCD panel display contrast	
P.Fn-04		LCD panel illumination color	
P.Fn-05	 QUICK	Quick flash	p.105



If the Custom Functions screen is not displayed even if you hold down the function button 1 <  /C.Fn >, set the camera's power switch to <OFF>, or remove the MT-26EX-RT from the camera and operate.

Clearing All the Custom/Personal Functions

When function button 2 < CLEAR >, then function button 1 < OK > are pressed on the Custom Functions screen, all the Custom Functions that have been set are cleared.

Similarly, when the same operations are performed on the Personal Function screen, all the Personal Functions that have been set are cleared.



You can set or clear all Custom Functions of the MT-26EX-RT on the camera's menu screen (p.56).

C.Fn: Setting Custom Functions

C.Fn-01: (Auto power off)

When the MT-26EX-RT is not operated for approx. 90 sec., the power turns off automatically to save energy. You can disable this function.

0: ON (Enabled)

1: OFF (Disabled)



Even if the auto power off is set to <0: ON>, the power will not be turned off when the focusing lamp is lit.



C.Fn-02: MODELING (Modeling flash)

0:  (Enabled (Depth-of-field preview button))

Press the camera's depth-of-field preview button to fire the modeling flash.

1:  (Enabled (Test flash button))

Press the MT-26EX-RT's test flash button to fire the modeling flash.

2: /  (Enabled (with both buttons))

Press the camera's depth-of-field preview button or the MT-26EX-RT's test flash button to fire the modeling flash.

3: OFF (Disabled)

Disables the modeling flash.



When the metering timer, etc. on the camera is operating, firing modeling flash with test flash button is not possible.

C.Fn-03: AUTO CANCEL (FEB auto cancel)

You can set whether or not to cancel FEB automatically after shooting three shots with FEB.

0: ON (Enabled)

1: OFF (Disabled)

C.Fn-04: (FEB sequence)

You can change the FEB shooting sequence. 0: Standard exposure, -: Decreased exposure (darker) and +: Increased exposure (brighter).

0: 0 → - → +

1: - → 0 → +

C.Fn-12: (Flash recycle with external power)

0: (External & internal power)

Charges in parallel, using both internal and external power sources.



1: (External power only)

You can minimize the consumption of the internal power source by using only external power source to charge for firing the flash, while internal power source is required to control the MT-26EX-RT.

C.Fn-13: (Flash exposure compensation setting)

0: (Speedlite button and dial)

1: (Speedlite dial only)

You can directly set the flash exposure compensation amount and flash output by turning < > without pressing the < > button.

C.Fn-18: LAMP (Macro: Focusing lamp on/off)**0: LAMP (With focusing lamp button)**

Press the <LAMP> button to turn on/off the focusing lamp.

1:  x2 (Half press shutter button twice)

Press the shutter button halfway twice quickly (double-click) to turn on/off the focusing lamp. This function is convenient when you do not have a free hand during shooting. You can also switch on/off the focusing lamp by pressing the <LAMP> button.



- If you use AF to focus with this function set to 1, be careful how you press the shutter button. The focusing lamp may turn on accidentally.
- If you use this flash unit with EOS D60 or EOS D30, it will not operate properly even if you press the shutter button halfway twice quickly (double-click). Use the <LAMP> button to switch on/off the lamp.

C.Fn-22:  (LCD panel illumination)

When a button or dial is operated, the LCD panel illuminates. You can change this illumination setting.

0: 12sec (On for 12 sec.)**1: OFF (Disable panel illumination)****2: ON (Illumination always on)**

P.Fn:Setting Personal Functions

P.Fn-01: LAMP (Macro: Focusing lamp brightness)

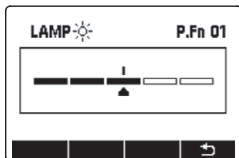

You can adjust the brightness of the focusing lamp in 5 levels.

P.Fn-02: LAMP (Macro: Focusing lamp on time)

You can select the lighting time of the focusing lamp.

0: 20sec (20 sec.)

1: 5min (5 min.)

P.Fn-03: (LCD panel display contrast)

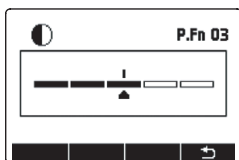

You can adjust the contrast of the LCD panel in 5 levels.

P.Fn-04: (LCD panel illumination color)

You can select the color of the LCD panel illumination.

0: GREEN (Green)

1: ORANGE (Orange)

P.Fn-05:  QUICK (Quick flash)

You can set whether or not to fire the flash (fire the Quick flash) when the flash-ready lamp is lit in green (before the flash is fully charged) to shorten the charge waiting time.

0: ON (Enabled)

1: OFF (Disabled)



When Quick flash (p.27) is fired during continuous shooting, underexposure may occur since the flash output decreases.

6

Reference

This chapter provides a system map and troubleshooting guide, and describes the use of the MT-26EX-RT with Type-B cameras.

MT-26EX-RT System

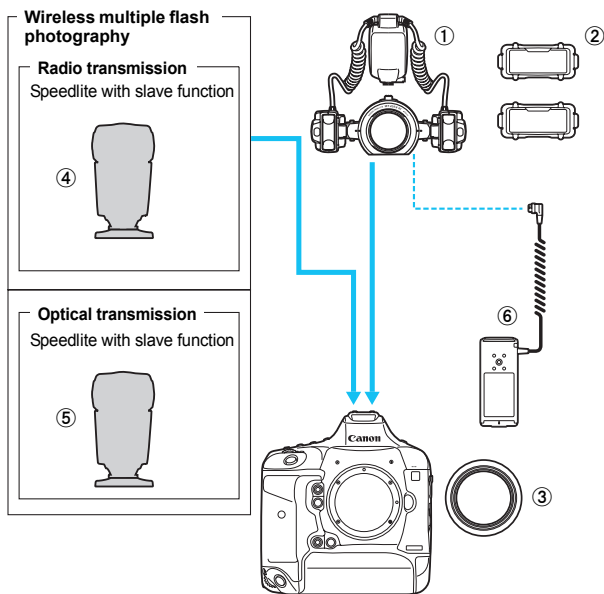

① **Macro Twin Lite MT-26EX-RT**

② **Diffuser Adapter SDA-E1** (Provided with MT-26EX-RT)

③ **Macrolite Adapter**

An adapter for attaching the flash unit to the lens (p.21).

- ④ **Speedlite equipped with radio transmission wireless slave function**
600EX II-RT, 600EX-RT, 430EX III-RT
- ⑤ **Speedlite equipped with optical transmission wireless slave function**
600EX II-RT, 600EX-RT, 600EX, 580EX II, 580EX, 550EX,
430EX III-RT/430EX III, 430EX II, 430EX, 420EX, 320EX, 270EX II
- ⑥ **Compact Battery Pack CP-E4N**
A small and lightweight external power source with superior portability.

- When using a Speedlite without a function for switching the firing groups (A, B, C) in ⑤, you can use the Speedlite as a slave in firing group A during optical transmission wireless multiple flash shooting (you cannot use it as a slave in firing group B or C).
- Using an external power source other than Canon may result in a malfunction.

 For external power source, use of the Compact Battery Pack CP-E4N (sold separately) is recommended.

Flash Firing Restrictions due to Temperature Increase



When continuous flash or modeling flash is repeatedly fired in short intervals, the temperature of the flash heads, batteries, and the area near the battery compartment may increase.

When you perform firing repeatedly, the firing interval increases in steps within the range of up to approx. 20 sec. to avoid degrading or damaging the flash heads due to overheating. When you perform firing repeatedly even more in this state, flash firing is restricted automatically.

Furthermore, when flash firing is restricted, a warning icon is displayed to indicate the increase in temperature, and the firing interval (with which the flash photography can be performed) will be automatically set to approx. 8 sec. (level 1) or approx. 20 sec. (level 2).

Temperature Increase Warning

As the internal temperature of the flash unit increases, the warning is displayed in two levels. When you perform continuous firing repeatedly even more in the state in level 1, the state changes to level 2.

Display	Level 1 (Firing interval: Approx. 8 sec.)	Level 2 (Firing interval: Approx. 20 sec.)
Icon		
LCD panel illumination	Red (lit)	Red (blinking)

Number of Continuous Flashes and Rest Time

The following table shows the number of continuous flashes until the warning (level 1) is displayed, and the necessary rest time (guideline) until normal flash photography can be performed.

Function	Number of Continuous Flashes to Reach Level 1 Warning (Guideline)	Necessary Interval Time (Guideline)
Continuous full output flash (p.17) Modeling flash (p.34)	48 times or more	25 min. or longer

 **CAUTION**

When performing continuous flash, do not touch the flash heads, batteries, or the area near the battery compartment.

When continuous flash or modeling flash is repeatedly fired at short intervals, do not touch the flash heads, batteries, or the area near the battery compartment. The flash heads, batteries, and area near the battery compartment may become hot, resulting in the risk of burn.



- Do not open or close the battery compartment cover while flash firing is being restricted. Doing so is very dangerous since the flash firing restriction is canceled.
- Even when level 1 warning is not displayed, the firing interval will be extended as the flash heads begins to heat up.
- If level 2 warning is displayed, allow a rest time for at least 25 min.
- Even if you stop flash firing after level 1 warning is displayed, level 2 warning may be displayed.
- If flash photography is performed in high temperatures, the firing restrictions may be activated before the number of flashes listed in the table on the preceding page is fired.
- For cautions on the number of flash firings, see page 17 (continuous flashes) or page 34 (modeling flash).
- The MT-26EX-RT may not fire in rare cases due to environmental factors such as temperature rise.
- When the diffuser adapter is used, the number of continuous flashes until the warning is displayed becomes slightly fewer.
- When C.Fn-22-1 is set (p.103), the warning with red illumination of the LCD panel will not be displayed even if the temperature of the flash heads rises.
- When using Compact Battery Pack CP-E4N (sold separately), also refer to the CP-E4N Instruction Manual.

Troubleshooting Guide

If a problem occurs with the flash, first refer to this Troubleshooting Guide. If this Troubleshooting Guide does not resolve the problem, contact your dealer or nearest Canon Service Center.

● Normal Flash Photography

The power does not turn on.

- Make sure the batteries are installed in the correct orientation (p.18).
- Make sure the battery compartment cover is closed (p.18).
- Replace the batteries with new ones.
- Insert batteries into the flash unit even when using an external power source (p.109).

The MT-26EX-RT does not fire.

- Insert the control unit's mounting foot into the camera's hot shoe all the way, slide the lock lever to the right, and secure the control unit to the camera (p.20).
- If the < **CHARGE** > indication remains displayed for approx. 30 sec. or longer, replace the batteries (p.18).
- If the electrical contacts of the control unit or camera are dirty, wipe the contacts (p.11) with a dry cloth, etc.
- When you perform continuous firing repeatedly over a short period of time, causing the temperature of the flash heads to rise and flash firing to be restricted, the firing interval increases (p.110).

The power turns off by itself.

- The MT-26EX-RT's auto power off has been activated. Press the shutter button halfway or press the test flash button (p.27).

Pictures are underexposed or overexposed.

- If there is a highly reflective object in the picture, use FE lock (p.42).
- If the main subject looks very dark or very bright, set flash exposure compensation (p.40).

- With high-speed sync, the faster the shutter speed, the lower the guide number becomes. Move closer to the subject (p.43).
- Do not fire slave unit C directly pointing toward the main subject (p.58, 82).

The picture is very blurred.

- When the shooting mode is set to the aperture-priority AE (**Av**) mode and the scene is dark, slow sync is enabled automatically (the shutter speed becomes slower). Use a tripod, or set the shooting mode to the program AE (**P**) or fully automatic mode (p.32). Note that you can also set the sync speed in [**Flash sync. speed in Av mode**] (p.54).

Functions cannot be set.

- Set the camera's shooting mode to <**P/Tv/Av/M/bulb(B)**> (Creative Zone mode).
- Set the MT-26EX-RT's power switch to <**ON**> instead of <**LOCK**> (p.27).

The LCD panel illumination turns on and off.

- The master unit's LCD panel illuminates or turns off according to the charge status of the slave units (firing groups). See "LCD Panel Illumination" on page 72.

Flash ratio cannot be set from the camera's menu screen.

- Set the flash ratio by operating the flash (p.38).

● Radio Transmission Wireless Multiple Flash Photography

The slave unit does not fire or unexpectedly fires at full output.

- Set the master to <(☑) **MASTER**> and the slave to <(☑) **SLAVE**> (p.64).
- Set the transmission channels and wireless radio IDs of the master unit and slave unit to the same numbers (p.65, 66).
- Make sure the slave unit is within the transmission range of the master unit (p.58).
- Run the transmission channel scan and set the channel with the best reception signal (p.66).
- Position the slave unit at a location with the clearest possible view of the master unit.
- Face the front side of the slave's main body toward the master unit.

Pictures are overexposed.

- When performing autoflash photography with three firing groups A, B, and C, do not fire with firing group C pointing toward the main subject (p.74).
- When shooting in a different flash mode set for each firing group, do not fire with multiple firing groups set to <**ETTL**> or <**Ext.A**> pointing toward the main subject (p.80).

<Tv> is displayed.

- Set the shutter speed 1 stop slower than the maximum flash sync speed (p.62).

Cannot remote release from a slave unit.

- Remote release is not possible from a slave unit with cameras released up to 2011 or with EOS REBEL T6/1300D or EOS REBEL T5/1200D.

● Optical Transmission Wireless Multiple Flash Photography

The slave unit does not fire or unexpectedly fires at full output.

- Set the master to < ⚡ **MASTER** > and the slave to < ⚡ **SLAVE** > (p.85).
- Check that the firing group of the slave unit is set properly.
- Set the transmission channels of the master unit and slave unit to the same numbers (p.86).
- Make sure the slave unit is within the transmission range of the master unit (p.82).
- Point the wireless sensor of the slave unit toward the master unit (p.82).
- Position the slave unit at a location with the clearest possible view of the master unit.
- If the master unit and slave unit are too close, the transmission may not take effect properly.

Pictures are overexposed.

- When performing autoflash photography with three firing groups A, B, and C, do not fire with firing group C pointing toward the main subject (p.92).

Specifications

● Type

Type:	E-TTL II/E-TTL autoflash Twin flash for close-up photography
Compatible cameras:	Type-A EOS cameras (E-TTL II/E-TTL autoflash) Type-B EOS cameras (Autoflash photography not possible)
Flash coverage:	Approx. 65° up and down, approx. 65° left and right (flash head standard position, each side)
Flash head movable angle:	Vertically from standard position: 45° upward (22.5° increments) / 45° downward (22.5° increments) Horizontally: 60° inside (15° increments) / 30° outside (15° increments) Rotation on mount ring: 50° upward (5° increments) / 30° downward (5° increments)
Guide No.:	With both-sides firing: 26.0/85.3 (ISO 100, in meters/feet) With single-side firing: 19.9/65.3 (ISO 100, in meters/feet)
Flash duration:	Normal flash: Approx. 1.8 ms or less, Quick flash: Approx. 2.3 ms or less
Color temperature information transmission:	Flash light color temperature information transmitted to camera when flash is fired
Filter:	58 mm filter attachable to flash unit front surface
Focusing lamp:	Coverage Approx. 60° up and down, Approx. 60° left and right Light intensity adjustable

● Exposure Control

Exposure control system:	E-TTL II/E-TTL autoflash, manual flash
Effective flash metering range:	Varies depending on the angle of flash heads and the lens used.
Flash mode:	Both-sides firing / Single-side firing
Flash ratio control:	8:1 - 1:1 - 1:8, 1/2-step increments
Flash exposure compensation:	±3 stops in 1/3- or 1/2-stop increments
FEB:	±3 stops in 1/3- or 1/2-stop increments (can be combined with flash exposure compensation)
FE lock:	Possible with the camera's Multi-function button or FE lock/AE lock button

High-speed sync:	Possible * During radio transmission wireless multiple flash shooting, high-speed sync is possible only with EOS DIGITAL cameras released in and after 2012 (except with EOS REBEL T6/1300D and EOS REBEL T5/1200D).
Manual flash:	1/1 - 1/512 power (1/3-step increments) * During radio or optical transmission wireless multiple flash shooting: 1/1 to 1/128 power * During high-speed sync shooting: 1/1 to 1/64 power
Modeling flash:	Fired with camera's depth-of-field preview button or MT-26EX-RT's test flash button

● Flash Recharge

Firing interval (Recharge time):	Normal flash: Approx. 0.1 - 5.5 sec., Quick flash: Approx. 0.1 - 3.3 sec. * When using AA/LR6 alkaline batteries
Flash-ready lamp:	Lights up in red: Normal flash available Lights up in green: Quick flash available

● Radio Transmission Wireless Master Function

Frequency:	2405 MHz - 2475 MHz
Modulation system:	Primary modulation: OQPSK, Secondary modulation: DS-SS
Wireless settings:	Master
Transmission channel:	Auto, Ch.1 - 15
Wireless radio ID:	0000 - 9999
Slave unit control:	Up to 5 groups (A, B, C, D, E), up to 15 units
Slave unit setting:	Firing group A, B, C, D, E
Transmission distance:	Approx. 10 m / 32.8 ft. * With no obstacles or obstructions between the master and slave units with no radio interference with other devices * Transmission distance may be shorter due to the relative positions of the units, surrounding environment, weather conditions, etc.

● Optical Transmission Wireless Master Function

Connection method:	Optical pulse
Transmission channel:	Ch.1 - 4
Slave unit control:	Up to 3 groups (A, B, C)
Transmission range:	Indoors: Approx. 0.2 - 10 m / 0.7 - 32.8 ft. (at the front) Outdoors: Approx. 0.2 - 6 m / 0.7 - 19.7 ft. (at the front)

● Customization Features

Custom Functions:	8 types
Personal Functions:	5 types

● Power Source

MT-26EX-RT power source:	Four AA/LR6 alkaline batteries * AA/HR6 Ni-MH batteries can be used
Number of flashes:	Approx. 100 - 700 times * When using AA/LR6 alkaline batteries
Power saving:	Power off after approx. 90 sec. of idle operation * Power off after approx. 5 min. of idle operation during radio transmission wireless multiple flash shooting
External power source:	Compact Battery Pack CP-E4N can be used

● Dimensions and Weight

Dimensions (W x H x D):	Flash heads: Approx. 62.3 x 55.8 x 49.1 mm/2.45 x 2.20 x 1.93 in. Control unit: Approx. 69.5 x 112.5 x 90.0 mm/2.74 x 4.43 x 3.54 in. Mount ring: Approx. 136.6 x 91.1 x 29.9 mm/5.38 x 3.59 x 1.18 in.
Weight:	Approx. 570 g/ 20.1 oz. (MT-26EX-RT only, excluding batteries)

- All specifications above are based on Canon's testing standards.
- Product specifications and the exterior are subject to change without notice.

Guide Number (ISO 100, in approx. meters/feet)**Normal Flash**

Flash Output	Both-sides Firing	Single-side Firing
1/1	26.0/85.3	19.9/65.3
1/2	18.4/60.4	14.1/46.3
1/4	13.0/42.7	10.0/32.8
1/8	9.2/30.2	7.0/23.0
1/16	6.5/21.3	5.0/16.4
1/32	4.6/15.1	3.5/11.5
1/64	3.3/10.8	2.5/8.2
1/128	2.3/7.5	1.8/5.9
1/256	1.6/5.2	1.2/3.9
1/512	1.2/3.9	0.9/3.0

High-speed Sync (at full output)

Shutter Speed	Both-sides Firing	Single-side Firing
1/125	16.2/53.2	12.4/40.7
1/160	15.4/50.5	11.8/38.7
1/200	14.4/47.2	11.0/36.1
1/250	12.8/42.0	9.8/32.2
1/320	11.4/37.4	8.8/28.9
1/400	10.2/33.5	7.8/25.6
1/500	9.1/29.9	7.0/23.0
1/640	8.1/26.6	6.2/20.3
1/800	7.2/23.6	5.5/18.0
1/1000	6.4/21.0	4.9/16.1
1/1250	5.7/18.7	4.4/14.4
1/1600	5.1/16.7	3.9/12.8
1/2000	4.5/14.8	3.5/11.5
1/2500	4.0/13.1	3.1/10.2
1/3200	3.6/11.8	2.8/9.2
1/4000	3.2/10.5	2.5/8.2
1/5000	2.9/9.5	2.2/7.2
1/6400	2.5/8.2	2.0/6.6
1/8000	2.3/7.5	1.7/5.6

Using with a Type-B Camera

Available functions when using the Macro Twin Lite MT-26EX-RT with a Type-B camera (EOS film camera supporting TTL autoflash) are manual flash (p.45) and second-curtain sync (p.44) only. Other functions are not available.

When the MT-26EX-RT is attached to a Type-B camera, <ETTL> is displayed on the LCD panel of the flash. However, autoflash metering cannot be performed.

Radio Transmission Wireless Function

■ Countries and Regions Permitting Radio Transmission Wireless Function Use

Use of radio transmission wireless function is restricted in some countries and regions, and illegal use may be punishable under national or local regulations. To avoid violating radio transmission wireless function regulations, visit the Canon Web site to check where use is allowed.

Note that Canon cannot be held liable for any problems arising from radio transmission wireless function use in other countries and regions.

■ Model Number

MT-26EX-RT: DS401211 (including radio transmission wireless module model: CH9-1216)



FCC/IC NOTICE

**Model: DS401211 (including Radio Transmission Wireless Module
Model: CH9-1216, FCC ID: AZD216 / IC: 498J-216)**

This device complies with Part 15 of FCC Rules and Industry Canada's license exempt RSSs. Operation is subject to the following two conditions: (1) this device may not cause harmful interference, and (2) this device must accept any interference received, including interference that may cause undesired operation.

This equipment must not be co-located or operated in conjunction with any other antenna or equipment except Canon accessories supplied or designated for this product.

This equipment complies with FCC/IC radiation exposure limits set forth for an uncontrolled environment and meets the FCC radio frequency (RF) Exposure Guidelines and RSS-102 of the IC radio frequency (RF) Exposure rules. This equipment has very low levels of RF energy that is deemed to comply without testing of specific absorption rate (SAR).

Hereby, Canon Inc. declares that this equipment is in compliance with Directive 2014/53/EU.

The full text of the EU declaration of conformity is available at the following Internet address:

<http://www.canon-europe.com/ce-documentation>

Wireless Specifications

2404 MHz - 2476 MHz/ 4dBm

Please contact the following address for the original Declaration of Conformity:

CANON EUROPA N.V.

Bovenkerkerweg 59, 1185 XB Amstelveen, The Netherlands

CANON INC.

30-2, Shimomaruko 3-chome, Ohta-ku, Tokyo 146-8501, Japan



Model: DS401211 systems

This device complies with Part 15 of the FCC Rules. Operation is subject to the following two conditions: (1) This device may not cause harmful interference, and (2) this device must accept any interference received, including interference that may cause undesired operation.

Note: This equipment has been tested and found to comply with the limits for a class B digital device, pursuant to Part 15 of the FCC Rules. These limits are designed to provide reasonable protection against harmful interference in a residential installation. This equipment generates, uses and can radiate radio frequency energy and, if not installed and used in accordance with the instructions, may cause harmful interference to radio communications. However, there is no guarantee that interference will not occur in a particular installation. If this equipment does cause harmful interference to radio or television reception, which can be determined by turning the equipment off and on, the user is encouraged to try to correct the interference by one or more of the following measures:

- Reorient or relocate the receiving antenna.
- Increase the separation between the equipment and receiver.
- Connect the equipment into an outlet on a circuit different from that to which the receiver is connected.
- Consult the dealer or an experienced radio/TV technician for help.

Do not make any changes or modifications to the equipment unless otherwise specified in the manual. If such changes or modifications should be made, you could be required to stop operation of the equipment.

CAN ICES-3 (B) / NMB-3 (B)

The apparatus shall not be exposed to dripping or splashing.
Batteries shall not be exposed to excessive heat such as sunshine, fire, or the like.
Dry batteries shall not be subjected to charging.



Only for European Union and EEA (Norway, Iceland and Liechtenstein)

This symbol indicates that this product is not to be disposed of with your household waste, according to the WEEE Directive (2012/19/EU) and national legislation. This product should be handed over to a designated collection point, e.g., on an authorized one-for-one basis when you buy a new similar product or to an authorized collection site for recycling waste electrical and electronic equipment (EEE). Improper handling of this type of waste could have a possible negative impact on the environment and human health due to potentially hazardous substances that are generally associated with EEE. At the same time, your cooperation in the correct disposal of this product will contribute to the effective usage of natural resources. For more information about where you can drop off your waste equipment for recycling, please contact your local city office, waste authority, approved WEEE scheme or your household waste disposal service. For more information regarding return and recycling of WEEE products, please visit www.canon-europe.com/weee.

Graphical symbols placed on the equipment

— — Direct current

DISPOSE OF USED BATTERIES ACCORDING TO LOCAL REGULATIONS.

Index

Numerics

18% gray reflector	48
4 sec., 6 sec., 8 sec., 10 sec., 16 sec. timer	4

A

Accessories.....	15
Auto power off.....	28, 101
Av (Aperture-priority AE).....	32

B

Batteries.....	18
----------------	----

C

C.Fn.....	98, 101
Case.....	15
Clear all.....	56, 100
Clearing settings (Reverting to defaults)	49, 55
Color temperature information transmission.....	34
Creative Zone ...	4, 51, 57, 81, 97, 113
Custom Functions (C.Fn).....	98, 101

D

Diffuser adapter	15, 36, 108
------------------------	-------------

E

Effective flash metering range	35
E-TTL II flash metering	54
E-TTL II/E-TTL autoflash	30, 32
External power.....	102, 109

F

FE lock (FEL)	42
FEB	41, 55
Filter	25
Firing groups	58, 61, 74, 76, 78, 82, 84, 92, 94
Firing interval.....	17, 18, 110
Firing ratio control.....	55
A:B	38, 70, 89
A:B C.....	69, 74, 88, 92
RATIO button	38, 46, 64, 85
Flash control.....	52
Flash exposure compensation	40, 55, 73, 91
Flash exposure confirmation lamp	30, 89
Flash exposure level	12, 40, 48
Flash firing restriction	110
Flash function settings.....	51
Flash head.....	10
Switching.....	39, 47
Flash metering.....	54
Flash mode.....	12, 30, 54
Flash output.....	45, 76, 94
Flash positioning	58, 82
Flash sync speed	54, 62
Flash synchronization speed in Av mode	54
Flash-ready lamp.....	27, 70, 89, 105
Focusing lamp.....	33, 103, 104
Fully automatic flash photography..	30

- G**
- Gr (group firing) 78
- Group control 61, 84
- Group firing 78
- Guide number 120
- H**
- High-speed sync 43, 63, 73, 91
- Hood 26
- Hot shoe 20
- L**
- LCD panel 12
- Contrast 104
- Illumination 29, 72, 103, 104
- LOCK 28
- Lock function 28
- M**
- M (Manual exposure) 32
- Manual flash 45, 76, 94
- Flash output 45, 76, 94
- Multiple flash photography ... 76, 94
- Single-side firing 47
- Master 64, 85
- Memory function 68, 87
- Metered manual flash 48
- Macrolite Adapter 21, 108
- Modeling flash 34, 101
- Multiple flash photography 58, 82
- N**
- Nomenclature 10
- Normal flash 18, 120
- Number of flashes 18
- O**
- Optical transmission wireless multiple flash photography 81
- P**
- P (Program AE) 30, 32
- Personal Functions (P.Fn) 98, 104
- Power switch 27
- Q**
- Quick flash 18, 27
- R**
- Radio transmission wireless multiple flash photography 57
- Group firing 78
- RATIO 38, 69, 74, 76, 88, 92, 94
- Recharging 27
- S**
- Safety Instructions 8
- Scanning 66
- Second-curtain sync 44, 55
- Shutter speed 32
- Shutter synchronization 55
- Single-side firing 39, 47
- Slave unit
- Charge confirmation
 70, 72, 80, 89
- Slave unit setting 64, 85
- ☆ (Star) mark 4

Sync speed	62
System map	108

T

Temperature increase	110
Test flash.....	27, 71, 89, 101
Transmission channel	86
Transmission distance	58, 60
Transmission range	82
TTL autoflash	121
Tv (Shutter-priority AE)	32
Type-A camera.....	2
Type-B camera.....	121

W

Warning icon	62, 110
Wireless multiple flash photography	
A:B C	64, 69, 74, 85, 88, 92
Manual flash	76, 94
Wireless operation range	58, 82
Wireless photography	57, 81
Wireless radio ID.....	65
Wireless settings.....	64, 85

Canon

The descriptions in this Instruction Manual are current as of July 2017. For information on the compatibility with any products introduced after this date, contact any Canon Service Center. For the latest version Instruction Manual, refer to the Canon Web site.